

THE NEW BENCHMARK IN FLIGHT SIM TECHNOLOGY

FALCON[®]



4.0

MICRO PROSE[®]
www.microprose.com

TABLE OF CONTENTS

INTRODUCTION	xvi
About <i>Falcon 4.0</i>	xvi
How to Use This Documentation	xvii
CHAPTER 1: LEARNING HOW TO FLY	1-1
Overview	1-2
Training Mission Setup	1-3
How to Load a Training Mission	1-3
Freeze Mode	1-4
Mission 1: Basic Aircraft Handling	1-4
The HUD	1-5
HUD Control Options	1-7
Cockpit Instruments	1-7
Training Mission Overview	1-9
Initial Conditions	1-9
Mission Description	1-9
Mission 2: Takeoff	1-13
Training Mission Overview	1-13
Initial Conditions	1-14
Mission Description	1-14
CHAPTER 2: LEARNING TO TURN	2-1
Mission 3: Max G Turn at Corner Airspeed	2-2
Training Mission Overview	2-4
Initial Conditions	2-4
Mission Description	2-4
ACMI Debrief	2-7
Mission 4: Max G Turn Well Above Corner Airspeed	2-7
Training Mission Overview	2-8
Initial Conditions	2-8
Mission Description	2-8
ACMI Debrief	2-9
Mission 5: Max G Turn Well Below Corner Airspeed	2-10
Initial Conditions	2-10
Mission Description	2-10
ACMI Debrief	2-11
Mission 6: Minimum Altitude Split S	2-12
Training Mission Overview	2-14

Initial Conditions	2-14
Mission Description	2-14
ACMI Debrief	2-15
Mission 7: High-Speed Over-the-Top Maneuver	2-16
Training Mission Overview	2-16
Initial Conditions	2-16
Mission Description	2-17
ACMI Debrief	2-18
Mission 8: Low-Speed Over-the-Top Maneuver and Departures	2-19
Training Mission Overview	2-20
Initial Conditions	2-20
Mission Description	2-21
Deep Stalls	2-23
ACMI Debrief	2-24
CHAPTER 3: LANDING AND NAVIGATION	3-1
Mission 9: Landing From 10 nm out on Final	3-2
Training Mission Overview	3-2
Initial Conditions	3-2
Mission Description	3-2
Mission 10: Landing From a Base Leg Position Using the Instruments	3-7
Training Mission Overview	3-9
Initial Conditions	3-9
Mission Description	3-10
Mission 11: Flameout Landing	3-14
Training Mission Overview	3-15
Initial Conditions	3-15
Mission Description	3-15
Mission 12: Navigation and Timing	3-18
The Inertial Navigation System	3-18
Steering Cues	3-19
Getting to the Selected Steerpoint	3-20
The HSI	3-21
The HSD	3-22
Getting to the Selected Steerpoint on Time	3-23
Training Mission Overview	3-25
Initial Conditions	3-25
Mission Description	3-25
CHAPTER 4: AIR-TO-AIR WEAPONS	4-1
Mission 13: Air-to-Air Radar Modes	4-2

Overview of Air-to-Air Radar Modes	4-2
ACM	4-3
The B-Scope	4-6
RWS	4-7
TWS	4-11
VS	4-12
Training Mission Overview	4-12
Initial Conditions	4-12
Mission Description	4-12
Mission 14: 20mm Cannon (Air-to-Air)	4-14
Gun Sight Theory	4-15
Falcon Gun Sights	4-17
LCOS	4-17
EEGS	4-18
Snapshot Line	4-19
Training Mission Overview	4-19
Initial Conditions	4-19
Mission Description	4-20
Mission 15: AIM-9 Sidewinder	4-21
AIM-9 Mechanization	4-22
How to Call up Your Air-to-Air Missiles	4-24
Training Mission Overview	4-25
Initial Conditions	4-25
Mission Description	4-26
Mission 16: AIM-120 AMRAAM	4-27
AIM-120 AMRAAM Mechanization	4-28
How to Call up Your AIM-120s	4-29
Training Mission Overview	4-29
Initial Conditions	4-29
Mission Description	4-29
Mission 17: AIM-7 Sparrow	4-30
AIM-7 Sparrow Mechanization	4-32
How to Call up Your AIM-7s	4-32
Training Mission Overview	4-33
Initial Conditions	4-33
Mission Description	4-33
CHAPTER 5: AIR-TO-GROUND WEAPONS	5-1
Mission 18: Air-to-Ground Radar Modes	5-2
Ground Map Radar Mechanization	5-2
The Air-to-Ground Radar Display	5-2
Training Mission Overview	5-7

Initial Conditions	5-7
Mission Description	5-7
Mission 19: CCRP With Unguided Bombs	5-12
The CCRP Bombing Triangle	5-12
CCRP HUD Symbology	5-13
Training Mission Overview	5-14
Initial Conditions	5-14
Mission Description	5-14
Mission 20: CCIP Bombing	5-17
The CCIP Bombing Triangle	5-17
CCIP HUD Symbology	5-18
The CCIP Delay Cue (or How CCIP Becomes CCRP)	5-19
Training Mission Overview	5-20
Initial Conditions	5-20
Mission Description	5-20
Bombing Options	5-23
Mission 21: Dive Toss With Unguided Bombs	5-23
Dive Toss Employment	5-23
The Dive Toss Bombing Triangle	5-24
Dive Toss HUD Symbology	5-24
Training Mission Overview	5-26
Initial Conditions	5-26
Mission Description	5-26
Mission 22: 20mm Cannon (Air-to-Ground)	5-28
Training Mission Overview	5-28
Initial Conditions	5-28
Mission Description	5-29
Mission 23: Rockets	5-30
Training Mission Overview	5-30
Initial Conditions	5-30
Training Mission Description	5-31
Mission 24: AGM-65 Maverick Missile	5-32
Maverick Display	5-32
Maverick Mechanization	5-34
Maverick DLZ	5-39
Training Mission Overview	5-39
Initial Conditions	5-39
Mission Description	5-39
Mission 25: Laser-Guided Bombs	5-42
Targeting Pod Slave Mode	5-43
Targeting Pod Boresight Mode	5-44
Targeting Pod Mechanization	5-45

The Targeting Pod Display	5-45
HUD Displays	5-47
Training Mission Overview	5-47
Initial Conditions	5-47
Mission Description	5-47
Mission 26: HARM Air-to-Ground Missile	5-52
HTS Mechanization	5-53
The HTS Display	5-53
Shooting a HARM	5-55
HUD Displays	5-56
Training Mission Overview	5-57
Initial Conditions	5-57
Mission Description	5-57
CHAPTER 6: AIR-TO-AIR REFUELING	6-1
Mission 27: Air-to-Air Refueling	6-2
Finding the Tanker	6-2
Closing on the Tanker	6-4
Getting Gas	6-5
Training Mission Overview	6-7
Initial Conditions	6-7
Mission Description	6-7
CHAPTER 7: MISSILE THREAT REACTION	7-1
Mission 28: Missile Threat Reaction	7-2
Missile Guidance	7-2
Missile Flight Paths	7-4
Threat Warning System	7-5
Countermeasures	7-6
Training Mission Overview	7-7
Initial Conditions	7-7
Mission Description	7-7
CHAPTER 8: BASIC FIGHTER MANEUVERS	8-1
Mission 29: Offensive BFM	8-2
Turn Rate and Radius	8-4
Corner Airspeed	8-4
Airspeed Control	8-4
Energy	8-5
Flying Offensive BFM	8-5
Training Mission Overview	8-6
Initial Conditions	8-6
Mission Description	8-6

Mission 30: Defensive BFM	8-8
Training Mission Overview	8-11
Initial Conditions	8-11
Mission Description	8-11
Mission 31: Head-On BFM	8-14
Options at the Pass	8-14
One-Circle and Two-Circle Fights	8-18
Training Mission Overview	8-19
Initial Conditions	8-19
Training Mission Description	8-20
CHAPTER 9: INSTANT ACTION	9-1
Instant Action Options	9-2
Mission	9-3
Wave	9-3
Air Defenses	9-3
The Map	9-3
Ending Your Mission	9-4
CHAPTER 10: DOGFIGHT	10-1
Starting a Dogfight	10-2
Dogfight Setup	10-2
Furball	10-3
Team Furball	10-4
Match Play	10-4
The Map	10-5
Game Options	10-5
Saving a Dogfight Setup	10-6
Flying the Dogfight	10-6
Exiting the Dogfight	10-6
Reviewing Your Dogfight	10-6
CHAPTER 11: TACTICAL ENGAGEMENT	11-1
Opening Screen	11-2
Training Missions	11-3
Playing a Tactical Engagement	11-3
Loading a Tactical Engagement	11-4
Quick Start: Building a Simple Mission	11-5
Adding a Ground Strike	11-5
Adding Opposition	11-9
Adding Victory Conditions	11-11
Loading and Playing the Mission	11-14

Building Tactical Engagements	11-15
Tactical Engagement Terminology	11-15
The Tactical Engagement Editor	11-16
Mission Builder	11-17
Map Menus	11-19
Mission Builder Tools	11-22
Mission Builder Windows	11-31
Teams	11-36
Victory Conditions	11-38
Save and Restore	11-40
Exiting a Tactical Engagement	11-40
CHAPTER 12: CAMPAIGN	12-1
Understanding the Campaign	12-2
Jumping Into the Campaign	12-3
Saving Your Campaign	12-6
Creating a New Campaign	12-7
Preliminary Campaign Screen	12-7
Mission Schedule Screen	12-10
Using Intelligence	12-16
Mission Planning	12-20
Steerpoint Modification Menu	12-20
Flight Plan	12-21
Munitions Window	12-22
Entering the Mission	12-24
Taxiway vs. Runway Takeoff	12-24
Scramble	12-24
Saving a Campaign	12-25
Auto Save	12-25
Aborting a Mission	12-25
Ending a Mission	12-26
Debriefing	12-26
Winning and Dying in a Campaign	12-26
CHAPTER 13: LOGBOOK	13-1
Adding a New Logbook Entry	13-2
The Pilot Information	13-3
Pilot Picture	13-3
Callsign	13-3
Pilot	13-3
Password	13-3
Voice	13-3

Personal Data	13-4
Squadron Patch and Name	13-4
Rank	13-4
Career Statistics	13-5
Campaign Statistics	13-5
Dogfight Statistics	13-6
Medals	13-7
CHAPTER 14: ACMI	14-1
How to Record in ACMI	14-2
How to Review Your ACMI Tape	14-2
ACMI Controls	14-3
Events List	14-3
VCR Controls and Time Display	14-3
View Selection	14-4
View Manipulation Controls	14-6
Options	14-7
How to Delete an ACMI File	14-8
Screen Shots	14-8
CHAPTER 15: TACTICAL REFERENCE	15-1
Specification Panel	15-3
Entry Description	15-3
3-D Model Display	15-3
CHAPTER 16: SETUP	16-1
Simulation	16-2
Skill Level	16-2
Realism Rating	16-3
Flight Model	16-3
Avionics	16-3
Weapons Effects	16-3
Autopilot	16-3
Air Refueling	16-4
Padlocking	16-4
Invulnerability	16-4
Unlimited Fuel	16-5
Unlimited Chaff and Flares	16-5
No Collisions	16-5
No Blackout	16-5
Labels	16-5
Disable Clouds	16-5
Radio Calls Use Bullseye	16-5

ACMI File Size	16-5
Graphics	16-6
Video Driver	16-6
Video Card	16-6
Resolution	16-6
Textured Objects	16-7
Texture Smoothing	16-7
Transparency	16-7
Gouraud Shading	16-7
Haze	16-7
Terrain Texture	16-7
Terrain Detail	16-7
Object Detail	16-7
Object Density	16-8
Player Bubble	16-8
Vehicle Magnification	16-8
Special Effects	16-8
Canopy Cues	16-8
Defaults	16-9
Recommended Graphics Settings	16-9
Sound	16-10
Controllers	16-11
Game Controller	16-11
Key Mapping	16-14
CHAPTER 17: THE CONSOLES	17-1
HUD	17-3
AOA Indexer	17-4
AR Status/NWS Indicator	17-5
Master Caution Light	17-5
Left Eyebrow Warning Lights	17-6
IFF Button	17-6
Threat Warning System	17-6
ICP and DED	17-8
Fuel Flow Indicator	17-8
Right Eyebrow Warning Lights	17-8
Oil Pressure Indicator	17-9
Nozzle Position Indicator	17-9
RPM Indicator	17-9
MFDs	17-9
Airspeed/Mach Indicator	17-9
Altimeter	17-10
AOA Indicator	17-10

Attitude Director Indicator	17-10
Vertical Velocity Indicator	17-11
Horizontal Situation Indicator	17-11
Ejection Handle	17-13
Kneeboard	17-13
Voice Message System	17-13
Left Auxiliary Console	17-15
Autopilot Toggle Switch	17-15
Emergency Stores Jettison Button	17-15
Landing Gear Status Lights	17-15
Landing Gear Handle	17-16
Horn Silencer Button	17-16
Speed Brakes Position Indicator	17-16
HUD Control Panel	17-16
Auxiliary Threat Warning Panel	17-18
ECM Toggle Switch	17-18
Manual Pitch Override Switch	17-18
Radio Channel	17-18
Radio Function Knob	17-20
Right Auxiliary Console	17-21
Magnetic Compass	17-21
Fuel Quantity Indicator	17-21
Caution Light Panel	17-21
Clock	17-23
AVTR Toggle	17-23
Chaff/Flare Control Panel	17-23
Navigation System	17-24
CHAPTER 18: THE HUD	18-1
Basic HUD Information	18-2
Airspeed	18-2
Altitude	18-3
Altitude Low	18-3
Heading	18-3
Flight Path Marker	18-3
G Force Indicator	18-4
Max G Force Indicator	18-4
HUD Mode Indicator	18-4
Mach Indicator	18-5
Pitch Ladder	18-5
Steerpoint Marker	18-5
Gun Cross (Boresight Cross)	18-6
Low Fuel	18-6

SOI (Sensor of Interest)	18-6
Break-X	18-6
RPM	18-7
Other HUD Modes	18-7
NAV Mode	18-7
Air-to-Air Missile	18-8
Air-to-Air Guns	18-14
Dogfight Mode	18-17
Missile Override Mode	18-18
Air-to-Ground Weapons	18-18
Rocket Launcher	18-25
Maverick AGM-65 Missile	18-26
Guided Bomb Units	18-29
AGM-88A HARM	18-31
Air-to-Ground Guns	18-33
Reconnaissance Pod	18-34
ILS	18-35
HUD Controls	18-36
Easy and Simplified Avionics	18-36
CHAPTER 19: THE MFDS	19-1
Option Select Buttons	19-2
MFD Pages	19-3
Main Menu Page	19-3
HSD Page	19-3
FCR Page	19-6
SMS Page	19-6
RWR Page	19-18
HUD Page	19-18
CHAPTER 20: THE ICP AND DED	20-1
DED	20-2
ICP	20-2
Increment and Decrement Buttons	20-2
Master Mode Buttons	20-2
Override Buttons	20-3
Priority Function Buttons	20-4
CHAPTER 21: THE RADAR	21-1
Radar Modes	21-2
Easy Mode	21-2
Air-to-Air Mode	21-3
Air-to-Ground Mode	21-4

Simplified Mode	21-5
Air-to-Air Mode	21-6
Ground Map Mode	21-9
Realistic Mode	21-9
FCR Page	21-9
Realistic Radar Air-to-Air Modes	21-9
Radar Jamming	21-25
Realistic Radar Air-to-Ground Modes	21-25
CHAPTER 22: THE VIEWS	22-1
Inside Views	22-2
HUD Only View	22-2
2-D Cockpit View	22-2
Virtual Cockpit View	22-4
Padlock View	22-5
Extended FOV View	22-7
Outside Views	22-8
View Controls	22-8
Satellite View	22-8
Action View	22-8
Tracking View	22-8
Enemy View	22-8
Incoming View	22-8
Weapon View	22-8
Weapon's Target View	22-9
Friendly View	22-9
Friendly Ground Unit View	22-9
Chase View	22-9
Flyby View	22-9
Orbit View	22-9
Other View Features	22-9
Labels	22-9
Canopy Reflections	22-10
Lift Line	22-10
Glance Forward and Glance Backward	22-10
Look Closer	22-10
Night Vision	22-10
Redout and Blackout	22-10
CHAPTER 23: RADIO COMMANDS	23-1
AWACS Radio Commands	23-2
AWACS Page	23-2
Vector Page	23-3

Flight Radio Commands	23-4
Combat Management Page	23-5
Mission Management Page	23-7
Formation Management Page	23-8
Identification Management Page	23-11
Tower Radio Commands	23-11
Tanker Radio Commands	23-12
CHAPTER 24: AIRPORT OPERATIONS	24-1
Ground Operations	24-2
Departure	24-2
Recovery	24-3
Approach Procedures	24-3
Final Approach	24-5
Landing	24-6
Emergencies	24-6
CHAPTER 25: AERODYNAMICS AND G FORCES	25-1
The Forces Acting on the Aircraft	25-2
G Force	25-4
Maneuvering the Jet	25-5
Stalls	25-6
CHAPTER 26: ENEMY TACTICS	26-1
Connectivity	26-2
Synchronization	26-3
Redundancy	26-3
SAM Tactics	26-3
AAA Tactics	26-5
Enemy Fighter Tactics	26-6
Missions	26-6
BVR Tactics	26-7
Dogfight Tactics	26-10
CHAPTER 27: MISSION PLANNING AND EXECUTION	27-1
General Mission Planning	27-2
Changing Your Flight Plan	27-4
Adjusting Package Spacing	27-6
Target Planning	27-8
The Enemy	27-10
Ground Operations	27-11

Takeoff and Climbout	27-12
Ingress	27-12
Threat Reaction	27-15
Dealing With Enemy Aircraft	27-16
Dealing With SAMs	27-17
Dealing With AAA	27-19
The Attack Phase	27-20
Egress Phase	27-21
Conclusion	27-22
APPENDIX A: DESIGNER'S NOTES	A-1
A View From the Cockpit	A-2
A View From the Computer	A-3
The Compromise of Flight Simulation Design	A-3
The Campaign and the Simulation	A-4
Flight Model	A-4
Pilot Overload	A-5
Graphics	A-5
Terrain	A-5
Beyond the Bubble	A-6
Sounds	A-6
Radar and HUD Modes	A-6
Hyper-Action	A-6
GLOC	A-7
Tactical Engagement	A-7
User Interface	A-7
The Electronic Battlefield System	A-7
F-16A vs. F-16C	A-7
Flying the Real F-16	A-8
Final Thoughts	A-8
APPENDIX B: GLOSSARY	B-1
APPENDIX C: AIRPORT MAPS	C-1
How to Use the Maps	C-2
APPENDIX D: LINEUP CARD	D-1
INDEX	BM-1
CREDITS	BM-21
CUSTOMER SUPPORT	BM-25



INTRODUCTION

ABOUT FALCON 4.0

Falcon 4.0 carries on a proud tradition of presenting the most accurate, realistic and engaging F-16 flight simulator available anywhere. In *Falcon 4.0* you'll pilot the F-16 Fighting Falcon, one of the premier dogfighting and air-to-ground combat aircraft in the world today. A favorite of experienced combat pilots, the F-16 is widely used by the United States and allied air forces. *Falcon 4.0* simulates the F-16 with unbelievable fidelity. This is as real as it gets!

Inside *Falcon 4.0*, you'll find four main arenas of play.

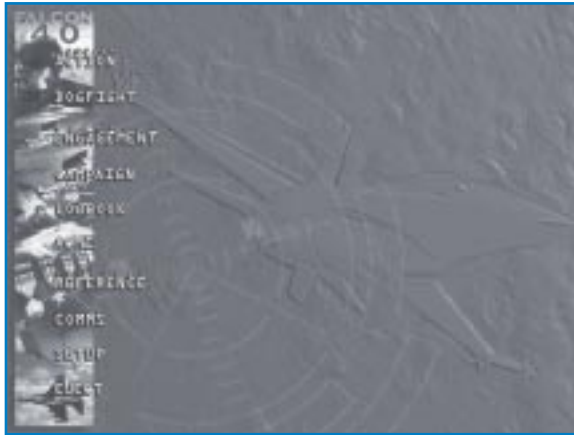

Instant Action is the place to go for an immediate adrenaline fix. Instant Action puts you into battle without any preliminaries. Your job is to shoot down as many aircraft and blow up as many ground targets as you can before you get killed. And you'll have to be good to stay alive, because in Instant Action the enemies keep coming.

Dogfight is where you'll duke it out in the skies under more controlled circumstances. In Dogfight, you'll go head-to-head with other aircraft, controlled by human or AI pilots. A Dogfight arena can contain from two up to literally hundreds of planes. The action can be a free-for-all or you can fly in teams.

Tactical Engagement is the *Falcon 4.0* construction set in which you'll build your own complete air and ground missions. Or load the missions that come with *Falcon 4.0*, ones that your friends create or others that you find on the Internet. Tactical Engagement is the ultimate free-form mission builder.



Campaign is the final challenge. In it, you're a highly trained F-16 pilot, a combat veteran assigned to a combat theater in which you'll play a vital role. The *Falcon 4.0* Campaign uses a complex real-time simulation engine that wages a major war on the Korean peninsula. Many battles are being fought simultaneously as you fly your sorties. If you successfully complete your missions, the enemy will be deprived of crucial supplies and your side will gain the edge. If you fail, the allied body count will start going up.

Other sections of *Falcon 4.0* provide important features.

The Logbook is where you'll keep your callsign and other personal information. The Logbook is *Falcon 4.0*'s way of knowing who's flying and keeps track of your points, rank and other statistics.

Tactical Reference is an important study guide for staying alive in the air. It shows you every aircraft, weapon, ground unit and naval unit you'll encounter in *Falcon 4.0*. Use it to learn to visually identify enemy aircraft. Learn the threat warning signals that enemy missiles and radar make, so you'll know when someone has locked you up with intent to kill.

ACMI (Air Combat Maneuvering Instrumentation) is the package that records everything that happens during a *Falcon 4.0* mission. It's one of the most useful tools you have as a fighter pilot because it gives you a chance to play back your mission, see your mistakes and glory in your brilliant moves.

HOW TO USE THIS DOCUMENTATION

Falcon 4.0 is a sophisticated simulator, but we have organized the documentation to get you flying right away. Be sure to read **The Cadet's Guide** first so you can install and configure the game. If you want to get in the air and shoot things down, **The Cadet's Guide** will tell you how.

Part 1 of this **Flight Handbook** covers all the training missions, from basic flying to operating the avionics and weapons suites. The training missions are where you'll learn the "how to" of flying an F-16. Part 2 describes all the main modules, including Instant Action, Dogfight, Tactical Engagement and Campaign. Part 3 is a reference section that covers the details of avionics, weapons suites, displays, radar, views, radio commands and so on. Part 4 is for the advanced pilot, with lessons about enemy tactics and mission planning.

In addition to the two manuals, be sure to keep the **Quick Reference Chart** handy. The key card is a handy summary of the basic commands and functions. If you're interested in multiplayer games, check out **The Communications Handbook**.

Don't feel overwhelmed by the amount of material presented here. If you're new to flight simulations, start with **The Cadet's Guide** which describes the simplified avionics and flight model. Use the training missions in Part 1 of this manual to learn more about the F-16. If you need help on the interface screens, click the Help icon (which looks like a question mark) for more information. Also, don't forget to check out our Web site at www.falcon4.com for even more training information and tips from real fighter pilots.

We've gone to great lengths to accurately model the F-16C Block 50/52 fighter jet. Given the sophistication of today's combat aircraft, it's no surprise that the U.S. government spends more than a million dollars to train a combat pilot. This means you won't learn *Falcon 4.0* overnight. However, each step is guaranteed to be interesting and exciting. Before long you'll be rocking the skies with the best of them. Good luck and good hunting!

PART 1: ***TRAINING MISSIONS***

CHAPTER 1: LEARNING HOW TO FLY

CHAPTER 2: LEARNING TO TURN

CHAPTER 3: LANDING AND NAVIGATION

CHAPTER 4: AIR-TO-AIR WEAPONS

CHAPTER 5: AIR-TO-GROUND WEAPONS

CHAPTER 6: AIR-TO-AIR REFUELING

CHAPTER 7: MISSILE THREAT REACTION

CHAPTER 8: BASIC FIGHTER MANEUVERS

CHAPTER

1



LEARNING HOW TO FLY

Part 1 of this **Flight Handbook** consists of 31 training missions. The missions themselves are located in the Tactical Engagement section of the game, and the mission descriptions and instructions are contained here in the manual. The missions are task-oriented and teach very specific skills. We'll provide all the instruction you'll need to complete each learning objective, but there is one caveat. The training missions use a building block approach. If you try to fly one of the advanced missions without first learning the skill sets from the earlier missions, you may have difficulty. Pete Bonanni designed these missions and wrote the instruction that follows. He patterned this training syllabus after the training course that the U.S. Air Force uses to teach new fighter pilots how to fly the F-16.



Pete "Boomer" Bonanni is a highly experienced F-16 instructor pilot some of you may remember from *Falcon 3.0*. Pete provided the primary fighter pilot input to the *Falcon 4.0* development team and is the author of *Art of the Kill* along with many other flight simulator books. His new book is titled *The Official Falcon 4.0 Strategy Guide* and is published by Prima.

OVERVIEW

These training missions are designed to teach you how to fly *Falcon 4.0* in the same way as a real F-16 pilot learns to fly his jet. *Falcon 4.0* is the most realistic flight simulation ever built, but it does feature scaleable levels of difficulty to aid new pilots. The skills and knowledge required to use the F-16's systems are not easy to learn, and will take time and effort to master. For this reason, I suggest you eat this elephant one bite at a time.

For further training, tips on techniques and other information about *Falcon 4.0*, don't forget to visit www.falcon4.com.



TRAINING MISSION SETUP

All of these training missions assume a specific setup. Please follow these instructions for *all* of the 31 training missions:

1. Select Setup from the main menu.
2. Click the Simulation tab at the top of the window.
3. Select “Ace” from the Skill Level option. This will set the Flight Model, Avionics, Weapons Effects, Autopilot, Air Refueling and Padlocking to the proper options.
4. On the right-hand side of the window, turn Labels on by clicking in the box. Also turn Disable Clouds on by clicking its box.

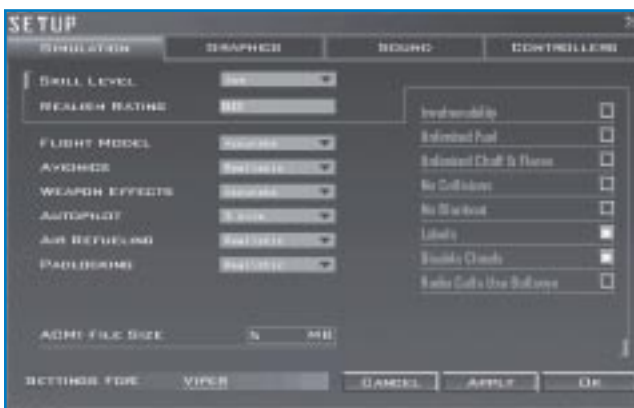

5. Click the Graphics tab at the top of the window.
6. Make your Graphics selections based on your processor, video card, available RAM, etc. See **Chapter 16: Setup** for recommended settings.

HOW TO LOAD A TRAINING MISSION

To load a training mission, first click Tactical Engagement from the main menu. The Training tab will already be selected, and a list of training missions will appear underneath. Click on the training mission you want and click the Commit button in the bottom right-hand corner. Under Mission Schedule on the next screen, the training mission will be selected and you will see the default name (“2nd Lt. Joe Pilot”) next to an aircraft icon. If you already created a pilot in the Logbook, you will see the name you selected instead. Click the Fly icon in the bottom right-hand corner to start the training mission.

FREEZE MODE

You can always press **[Shift][P]** at any time during the training mission to “freeze” the game. Unlike the regular pause mode (**[P]** key), freezing the game lets you operate all the F-16 avionics and instruments, most notably the radar. Note that the mission clock keeps ticking in Freeze mode. If you are supposed to be at a specific location at a specific time, the time you spend in Freeze mode counts against you.

MISSION 1: BASIC AIRCRAFT HANDLING

The objective of this mission is to learn how to control the Falcon. When you complete this mission, you will “know the struts and know the skin, know the barrel roll and spins.” Well, maybe not, but I just couldn’t resist that line from a famous old fighter pilot song “Barnacle Bill the Pilot.”

There is no need to take the venerable Falcon up into the wild blue to duke it out with the bad guys if you can’t control the jet. This mission is the first in a series of aircraft handling training missions patterned after the Air Force’s real F-16 training syllabus. In the real syllabus, this sortie is called “TR-1” or “Transition Sortie 1.” Keep in mind, however, that when a pilot first starts to fly the F-16, he or she already knows how to fly other jets. Since you *Falcon 4.0* faithful have different levels of experience, I will start with the very basics. Bear with me and if you start to nod off, move on to the next mission. Just don’t blame me later when you hear the low speed warning horn for the first time and soil your bloomers.

Controlling the plane in *Falcon 4.0* (and the real F-16) is really not very difficult. Fighting in the jet, however, is another matter. Modern fighters like the F-16 are a dream to fly but devilishly hard to fight in. Today’s fighters barrage the pilot with information which, when combined with increased speed, creates a tempo of air combat that is close to the limits of human capability. Along with the challenge of sensor fusion and tempo, modern fighters also feature a violent high-G environment. G force is the force that acts on the jet when it turns. It’s like the old example of swinging a bucket of water on the end of a rope. The water stays in the bucket because of the force acting toward the outside of the arc. The G force on an aircraft is essentially the same thing except greater in magnitude. The G forces of modern air combat would turn the fighters of old into kindling (or paper clips). The fighter pilots of yore, of course, faced challenges of their own. Their primary challenge was the sheer difficulty of just flying their aircraft. Older aircraft were simply a lot harder to fly than the F-16. Skills such as flying an F-86 close to its maneuvering limit, manual bombing in the F-105 and marksmanship in a P-51 demanded great flying skill. The F-16, in contrast, has a flight control computer that controls Gs and other critical flight parameters to keep the pilot out of trouble. In addition, the F-16 Fire Control Computer puts the bombs on the target. In general, the F-16 is just easier to fly. I experienced the difference between a third and fourth generation fighter when I transitioned from the F-4 Phantom to the F-16. With the exception of landing, I found the F-16 far easier to fly than the F-4.



Since *Falcon 4.0* flies like the real jet, it should be relatively easy to fly. Just because flying the jet is easy, however, does not mean that it is effortless or that there is no learning curve. This mission will help you master flying so you can go on to the more complex and demanding air combat tasks. We will also cover a few displays and instruments that are also shown in other parts of this manual. Everything you need to fly this mission will be presented here.

THE HUD

First, load the training mission by selecting “01 Basic Handling” under the Training tab in Tactical Engagement. Press **(Shift) P** to freeze the game while you look around the cockpit.

Falcon 4.0 features several views, but we will start with the cockpit. Press **(2)** on the top row of the keyboard to make sure you are in the 2-D Cockpit view. This cockpit not only looks exactly like the real F-16 cockpit but also features the same functionality. The most obvious cockpit feature is the HUD (Head-Up Display). The HUD is located at the top of the cockpit and is by far the most useful of all cockpit displays.

Here is a list of the parts labeled in Figure 1-1 and what they are used for in the HUD.

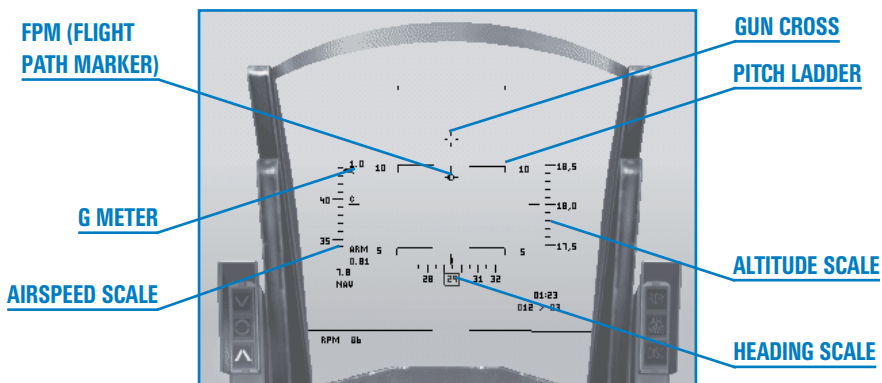

Figure 1-1

The **flight path marker** is the most useful part of the HUD. This symbol shows the pilot the flight path or vector that the jet is on. If you use your joystick to place the flight path marker on a point over the ground and hold it there, the jet will impact the ground on that exact spot. Hopefully, you won't be doing that too often, but the flight path marker can be used in a very similar way to fly to a precise point on a runway. Just as importantly, the F-16 can be flown in level flight or precise climbs and dives using the flight path marker.

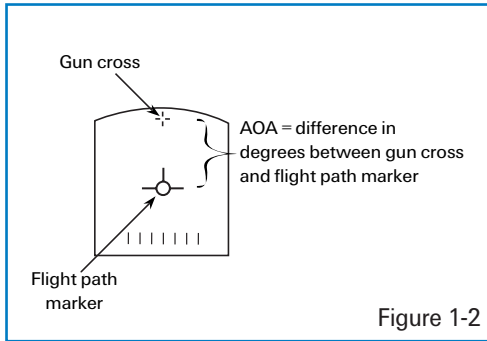

Figure 1-2

The gun cross is the small cross symbol at the top of the HUD. It is an important reference since it represents the nose of the aircraft. Keep in mind that the gun cross is not where the aircraft is pointing (although it is very close to where the aircraft is pointing). The difference between the gun cross (the nose of the aircraft) and the flight path marker is the AOA (Angle of Attack).

The pitch ladder provides a level flight reference along with a reference for climbs

and descents. The long solid horizontal line in the middle of the HUD is the 0° pitch line. It can be easily differentiated from the other pitch ladder lines because it has no number associated with it. The dashed pitch ladder lines show descents in 5° increments while the solid lines show climbs.

The airspeed scale is on the left side of the HUD. Since this scale shows airspeed in increments of tens, “40” means that you are going 400 knots (nautical miles per hour). The airspeed scale has a “C” next to the tick mark, which stands for calibrated airspeed.

The altitude scale is on the right side of the HUD. This scale shows aircraft altitude in hundreds of feet *above sea level*, also called MSL (Mean Sea Level). Remember, the HUD altitude scale shows altitude MSL—above sea level—and *not* altitude above the ground (AGL). An altitude of “500” is 5,000 feet above sea level. When your penguin butt gets down below 1,200 feet from the ground, the radar altimeter brings up a new altitude display in the HUD. Since this scale shows hundreds of feet, when the sliding bar is next to “2,” you are 200 feet above the ground. Keep in mind that this is the ground directly underneath your jet and not the ground that is in front of you. As you climb and get above 1,500 feet, the scale goes back to the normal sea level scale.

The heading scale at the bottom of the HUD shows aircraft heading. The scale simply shows aircraft heading in tens of degrees. A heading of “27” would be 270° .

The HUD G meter in the top left corner of the HUD shows current G forces acting on the jet, whereas the G meter at the bottom left corner of the HUD shows the maximum G force you have pulled so far during a given flight. See **Chapter 25: Aerodynamics and G Forces** for a detailed explanation of G.



HUD CONTROL OPTIONS

Figure 1-1 shows all the HUD displays called up, which is the way that I fly in both *Falcon 4.0* and the real F-16. Not all fighter pilots, however, use the HUD the same way, so you can configure your HUD display to suit your needs.

Press **[H]** to declutter the HUD. The first time you press **[H]**, it will remove the pitch ladder, the second time will remove the flight path marker. Press **[H]** a third time to return to the default HUD display.

Press **[Ctrl][H]** to toggle the airspeed indicator and altimeter from tapes to discretets (analog to digital).

Press **[Alt][H]** to change the HUD color. Since the ground can be colored green, this option can be very useful.

The HUD displays a lot more information, but we will talk more about diamonds and timing cues and that other stuff in the training missions to come.

COCKPIT INSTRUMENTS

We should discuss a number of cockpit instruments and displays before getting airborne. Make sure you are in the 2-D Cockpit view, as shown in Figure 1-3.

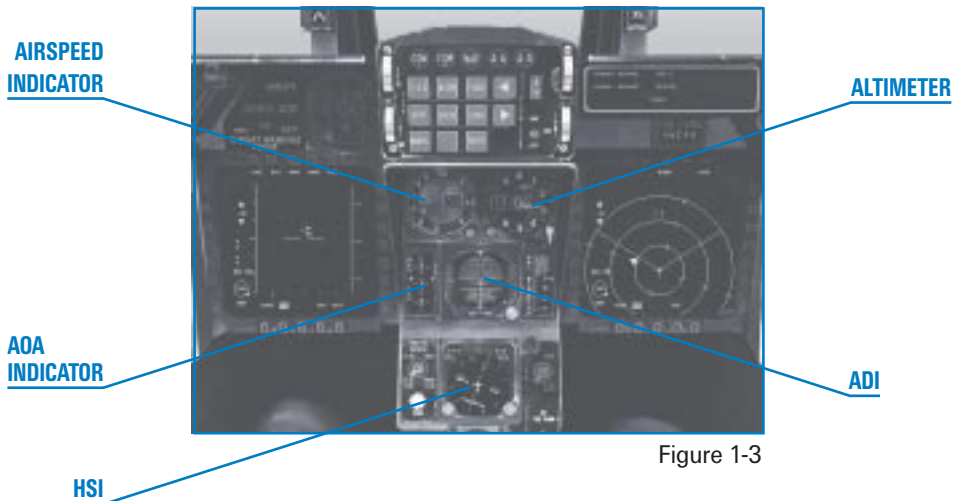

Figure 1-3

The ADI (Attitude Director Indicator) provides an artificial horizon and an aircraft symbol so you can tell the attitude or orientation of the aircraft relative to the earth.

The **airspeed indicator** shows the aircraft's airspeed in hundreds of knots. When the red needle is on the "4," you are going 400 knots.

The **altimeter** shows the MSL altitude (altitude above sea level) of the aircraft on the round dial. The digital readout on the inside of the dial shows the altitude in thousands of feet. The white needle on the dial displays the altitude in hundreds of feet.

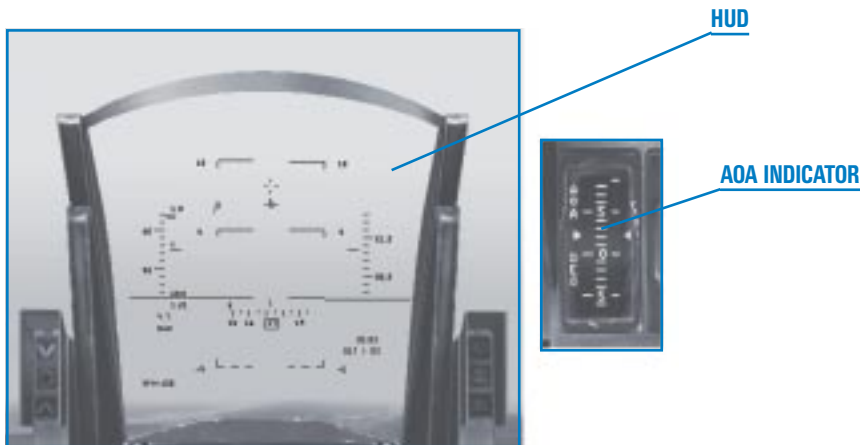

Figure 1-4a

The **AOA indicator** is a tape that shows the angle of attack of the aircraft. In order to generate lift, the jet needs to have a positive angle of attack or fly at a positive angle into the relative wind (airflow). The F-16 has a 25° positive and 5° negative AOA limit. Remember that the AOA is the angular difference between the gun cross and the flight path marker. Figure 1-4a shows AOA, both in the HUD and on the gauge.

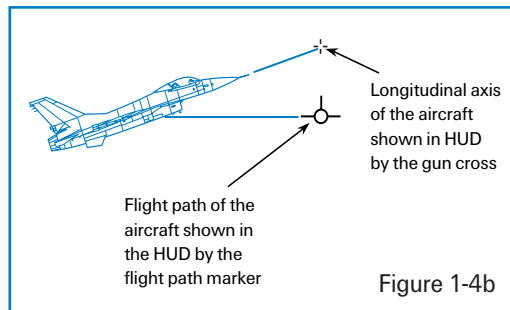

Figure 1-4b

The **HSI** (Horizontal Situation Indicator) is a very complex gauge we will cover in Training Mission 12. For now, all you need to know about the HSI is that it can be used to indicate aircraft heading. The round moving dial on the HSI shows N/S/E/W for north, south, east and west. When the aircraft turns, the dial moves to indicate the change in aircraft heading.



The **RPM gauge** shows the revolutions per minute of the turbine blades at the core of the engine. RPM is shown as a percentage, with 100% being the fastest the engine can go and 0% being an engine that is not turning at all. 70% is idle power. RPM is directly tied to throttle position, which controls how much thrust the engine produces.

TRAINING MISSION OVERVIEW

This mission starts with the Falcon in the air. Your goal on this mission is to get used to flying the jet and using the keyboard to control your various views.

INITIAL CONDITIONS

- ✦ Airspeed: 400 knots
- ✦ Altitude: 7,500 MSL and level
- ✦ Throttle Setting: Mid-range

MISSION DESCRIPTION

1. Press **[Shift][P]** to freeze the game. While we are frozen, let's go through the different view options. Access the views by pressing the number keys at the top of the keyboard.

Press **[1]** to switch to the HUD Only view. The MFDs are the boxes visible at the bottom (or top) of the display. Change the MFD displays by pressing **[1]** for the left MFD, **[2]** for the right MFD, **[Shift][1]** for the top left MFD and **[Shift][2]** for the top right MFD.

Press **[2]** to put you back in the default 2-D Cockpit view. This view is mouseable, which means that you can use the mouse to flip switches, turn dials and move around the cockpit. There are three kinds of mouse pointers that are used in the 2-D cockpit. The red diamond indicates that you cannot interact with a cockpit control or dial. The green circle means that you can interact with a cockpit control or dial (by flipping a switch, etc.). The green arrow means that you can click to change your 2-D Cockpit view to look left, right, etc.

Press **[3]** to enter the Virtual Cockpit. In Virtual Cockpit, use the hat switch on your joystick or press **[↑]**, **[↓]**, **[←]** and **[→]** on the numeric keypad to move your view around the cockpit. This view is very important because it is very useful in air combat and in improving your situational awareness or SA. SA is understanding where you are in relation to the world around you and, just as importantly, understanding where threats are in relation to you. Practice using the Virtual Cockpit while the simulation is in Freeze mode. If you hold down **[←]** or **[→]**, notice that your view will stop near the ejection seat. Since you cannot see past the ejection seat in the real F-16, *Falcon 4.0* has the same view limitation. You will hear a banging sound when you reach that limit. If you want to rotate your head (the view) to the other side of the cockpit, press **[←]** or **[→]** on the numeric keypad again and you will move the view to the other side of the cockpit.

Press **[4]** to access the Satellite view, which is an overhead view of the world.

To get a closer look at the world, press **[L]**. Press **[L]** again to return to normal view. You can also press **[7]** and **[1]** on the numeric keypad to zoom an outside view further in or out.

Falcon 4.0 has additional views, but they will not be needed in this mission.

- Bring up the 2-D Cockpit by pressing **[2]**. Press **[Shift][P]** again to unfreeze the game.
- Set the RPM gauge to 85% by using the throttle on your joystick or press **[+]** or **[-]** to set the throttle.

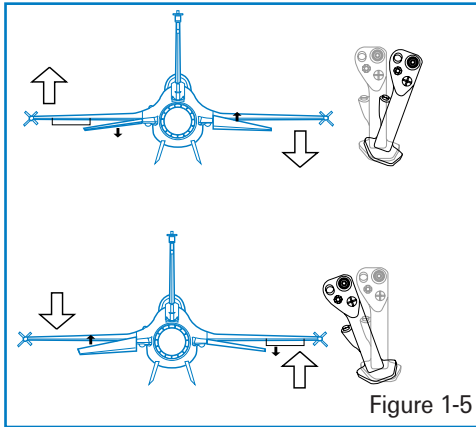

- Move your joystick left to start an easy left turn. Bank the wings to tilt the world about 60° and then pull back on the stick until your G meter reads 2.0. Figure 1-5 shows how to move your joystick and get the turn started.

Notice that when the wings are banked, the jet will turn or change heading. In the 2-D Cockpit view, you can watch the HUD heading scale move and you will see the aircraft banked on the ADI.

- To keep the aircraft in level flight, ensure that the flight path marker is on the level line of the HUD. Do this by gently pulling back on the joystick until you get the flight path marker where

**FLIGHT PATH
MARKER (FPM)**

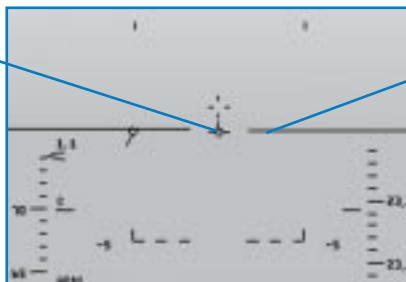

0° PITCH LINE



you want it. Figure 1-6 shows the turn with the flight path marker on the level or 0° pitch line. Practice making level turns to the right and left. Turn on the smoke by pressing (Alt) S to trace your path through the sky. Use the Satellite view (F5 key) to watch your turns from outside the aircraft. When you are done, return to straight and level flight. Bank opposite to the direction you are turning until the HUD 0° line is horizontal. Then move the flight path marker until the horizontal lines of the flight path marker align with the 0° line on the HUD.

6. Next, we will practice climbs and descents. To climb, align the HUD flight path marker with the 5° pitch line. Notice that the aircraft starts to climb and that both the cockpit and HUD altimeters show increasing numbers and that your airspeed decreases (if you don't, add more power). In addition, the movement of your flight path marker lags slightly behind your control inputs. After climbing 1,000 feet, level off for a few seconds by aligning your flight path marker with the level line. Notice that your altitude remains constant with the flight path marker on the 0° pitch or level line.
7. Practice a descent by pushing the joystick gently forward to align the flight path marker with the -5° pitch line. Your altitude will now decrease and your airspeed will increase. You must always manage your energy when flying. Climbs trade airspeed for altitude, whereas descents trade altitude for airspeed. After descending 1,000 feet, level off by placing the flight path marker on the HUD level line.
8. After accomplishing level turns and some straight ahead climbs, start combining turns and climbs together. For example, make a level turn due west, or "27" on your HUD heading tape. When you are heading west, start a climbing turn to east or "09" on the HUD heading tape. Try to climb 2,000 feet precisely. Set up parameters of your own to practice maneuvering the jet precisely.
9. Next, try doing level turns at low altitude, which is flying below 1,000 feet AGL. During these maneuvers, experiment with different HUD altitude options (Auto, Bar and Radar). Switch between these modes by using the mouse to switch to the lower left console in the 2-D Cockpit view. The HUD control panel on this console is a 3-way toggle switch that selects the

HUD altitude options.

The next series of maneuvers we are going to practice are called HARTs, which stands for "Horn Awareness Recovery Training." These maneuvers are used to train the pilot to recognize and recover from a nose high attitude. When the jet is above 45° nose high and the airspeed goes below 170 knots, the low speed horn comes on. Actually, it is a combination of pitch (nose relative to the horizon) and airspeed. Figure 1-7 shows the low speed warning horn chart used by the F-16. You don't have to memorize the chart. Just be aware that if you

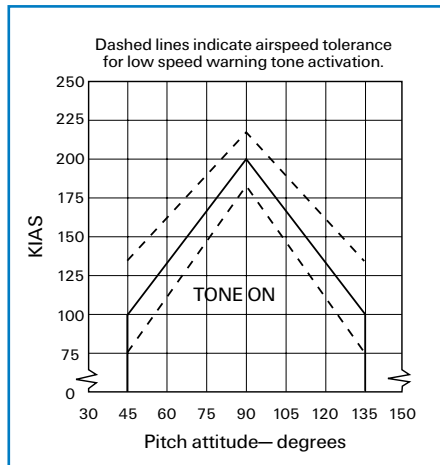

Figure 1-7

get nose high and slow, the horn will come on.

Use the following steps to practice HART maneuvers:

1. Climb to 15,000 feet and level off. Set the throttle to 85%.
2. Pull hard back on the stick and start an easy 5 G to 7 G pull-up straight ahead, to set the flight path marker 70° nose high using the HUD pitch ladder. Since the flight path marker will lag the gun cross, use the gun cross initially to set your pitch. The flight path marker will catch up with the gun cross when the AOA is reduced. The AOA initially will be high

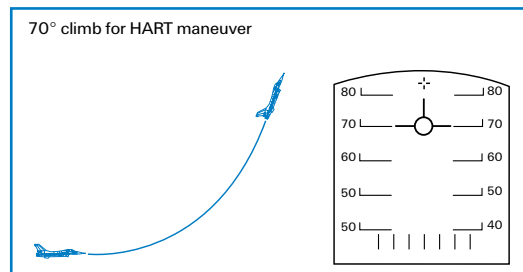

Figure 1-8



because you are pulling Gs, but it will come back down as you ease the pull to set your pitch angle at 70° . Figure 1-8 shows the climb.

3. The horn will come on at about 170 knots. When you hear the horn, start a roll to inverted flight. Make sure you roll the aircraft slowly to avoid losing control. Stop the roll when you are upside down. You can tell you are upside down by looking at the HUD pitch scales. When the vertical legs connected to the ends of the pitch bars are pointed, up then you are inverted.
4. Once the jet is inverted, start a smooth pull to get your nose down below the horizon. Once the nose of the jet is below the horizon, stop pulling on the joystick and let the nose fall through the horizon. Keep the jet inverted (upside-down).
5. When the airspeed gets to 150–200 knots, roll the jet upright and start a 3 G to 4 G pull to level flight (with the flight path marker on the 0° pitch line).
6. Try the exact same procedures except this time pull the nose of the jet up to 90° nose high. Use the Orbit view (**O** key) to watch how the aircraft performs at very low airspeeds.

This first training mission will help you practice controlling the jet using basic cockpit and HUD symbology. When you have turns, climbs and the HART maneuvers down pat, move on to the next mission.

MISSION 2: TAKEOFF

In this training mission, you will learn to fly the jet off the ground. Taking off in the F-16 is simple, and you only have to follow a few procedures. First, be aware that in *Falcon 4.0* that you are part of a realistic runway environment that includes a ground taxiway environment, air traffic control and other flights. All the runways in Korea are busy launching and recovering aircraft, so you must listen up for ATC (Air Traffic Control) radio calls directed at your flight. When taking off, you are not required to ask the tower for permission to take off. As you move down the taxiway, the tower will clear you for takeoff.

When you take off, you are generally combat configured, with bombs or missiles beneath your wings. Combat configurations are heavy. Because of the weight, you should accomplish all of your takeoffs with maximum afterburner. Things happen fast when you are taking off in full afterburner—and that is both good and bad news. The good news is that you don't have much time to get creative and mess up the procedures. The bad news is that if you don't use the correct takeoff procedures, bad things will start happening very fast.

TRAINING MISSION OVERVIEW

Load training mission "02 Takeoff" from Tactical Engagement and click the Commit button. You need to manually place yourself in the lower right-hand aircraft (the #2 plane). Do so by clicking on the plane icon.

Next, determine the callsign of your flight. Click the Briefing icon (which looks like an easel on the bottom of the screen). The third section, labeled "Package Elements," shows the name of your flight. In this case, your flight is Cowboy 1. In the section labeled "Ordnance," your aircraft is highlighted in green. In this case, your aircraft is Cowboy 12 (One-Two). When you hear ATC call "Cowboy One" or "Cowboy One-One," they are talking to your entire flight. If you are on the taxiway and are cleared for takeoff, taxi onto the runway and take off. If you are on the runway, just take off when you are cleared.

Close the Briefing window by clicking the "X" in the upper right-hand corner. Then click on the Fly icon in the lower right-hand corner. While you are waiting for the simulation to load, make sure that the throttle on your joystick is in the idle position.

INITIAL CONDITIONS

- ✦ Airspeed: 60 (which is the lowest reading in Realistic Avionics and will change once your airspeed is above 60 knots)
- ✦ Altitude: On the runway
- ✦ Throttle Setting: Idle
- ✦ Configuration: Gear down
- ✦ Avionics: NAV

MISSION DESCRIPTION

In this training mission, you will be on the runway. When the mission starts, you will be #2 in a two-ship formation with your flight leader on the runway ready for takeoff.

1. If your plane is moving as the mission starts, press and hold **[K]** to apply the wheel brakes. Release the **[K]** key when the jet comes to a stop.
2. Your callsign for this mission is Cowboy 12. Listen for Cowboy 11 to be cleared for takeoff by ATC. The radio call will be "Cowboy 11 cleared for takeoff." ATC might also call "Cowboy 1,



Figure 2-1

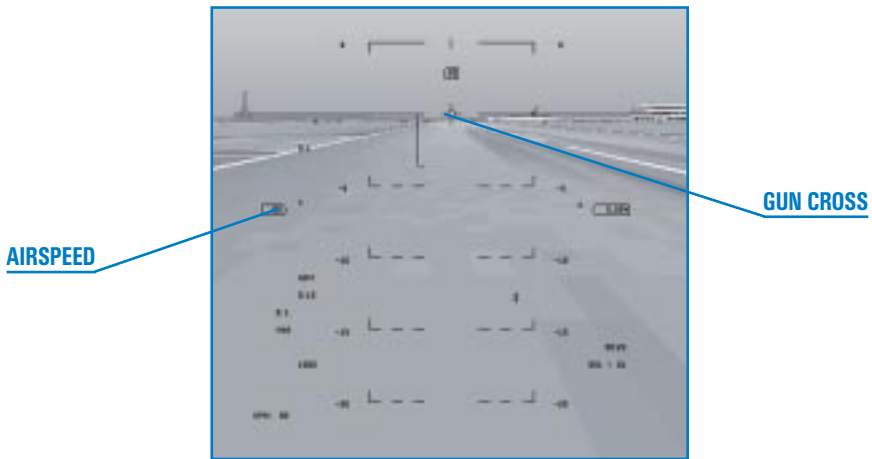

Figure 2-2

cleared for takeoff.” In either case, the entire flight is cleared to take off.

3. Increase your throttle to full afterburner by pressing **[Shift+]**.
4. Fly the jet straight down the runway using the joystick or rudder pedals to steer. Pay attention to both the runway and the airspeed gauge in the HUD.

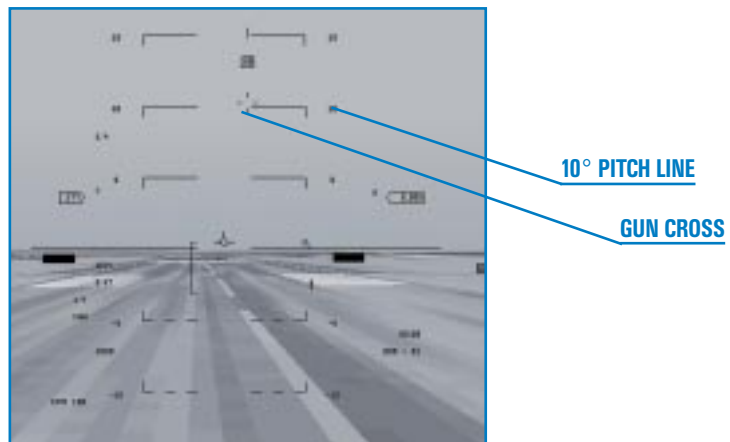





Figure 2-3

5. When the airspeed gets to 150 knots, pull the gun cross up to the 10° line in the HUD. Hold this pitch attitude until the jet flies off the runway. Warning: do *not* exceed a 14° pitch angle or you will scrape the afterburner nozzle on the runway.



Figure 2-4

6. As soon as you are airborne and climbing, raise the landing gear by pressing . This will happen quickly, so be ready to raise the gear *as soon as you get airborne*. Warning: do *not* exceed 300 knots with the gear down while flying or you will damage the landing gear.
7. Confirm the gear are up by switching to the lower left console (by pressing  on the numeric keypad followed by  on the numeric keypad). When the gear are in transit either up or down, the red light will be illuminated in the gear handle. When the gear are down and locked, you will see three green gear lights and the red light will go out in the gear handle. When the gear are safely up, the gear handle will be in the up position and the lights in the gear handle and on the panel above it will be extinguished.

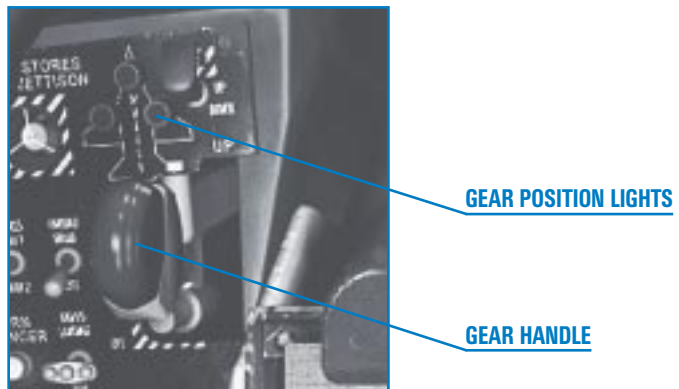

Figure 2-5

CHAPTER

2



***LEARNING TO
TURN***

In this chapter, you'll start by learning how to make basic turns and then advance to more complicated maneuvers at a variety of airspeeds.

MISSION 3: MAX G TURN AT CORNER AIRSPEED

The objective of this training mission is to practice maneuvering the jet in a tight turn. Turning the jet is a very important combat skill. Fighter aircraft like the F-16 Fighting Falcon are designed and built for one purpose: to close with the enemy and shoot them down. To do this, you must be able to turn your jet in the sky and point your missiles and guns at the enemy. Conversely, you must also be able to turn your jet and keep enemy aircraft from pointing their guns and missiles at you.

Turns have two basic defining characteristics which are important to understand. The first is turn rate (measured in degrees per second) or how fast the nose of the jet is moving across the sky. The next time you exit a circular highway offramp, note how fast the front of the car is moving past the surrounding terrain. That is your turn rate. The second characteristic of a turn is radius. Turn radius is simply how tight you are turning. In our example above, as you exit the offramp, the road sets the turn radius. In an aircraft, however, there are no roads to follow, so the pilot sets the turn radius.

Two factors affect both turn radius and turn rate: aircraft G and airspeed. Aircraft G is how hard you are turning the aircraft, which is determined by how much you are pulling back on the joystick. The more you pull back on the joystick, the more G you are commanding. This increased G will lead to a tighter turn radius and a faster turn rate—most of the time. Fighter aircraft have a limit to how much G you can pull. If you pull Gs beyond this limit, you will cause the aircraft to fail structurally or you will black out. The maximum G you can pull without breaking the jet is called max G. In older fighter jets, if the pilot pulled beyond max G, the jet might break apart. I have personally seen F-4 Phantom engines pulled from their mounting bolts and dropped into the engine bay due to an "over G." In the F-16, the aircraft is automatically limited to 9 Gs (max G) by a G-limiter built into the flight control system.

The other factor affecting turn rate and radius is airspeed. There is a direct relationship between airspeed and G and, in combination, they affect turn rate and radius. Simply put, the F-16 has an optimum airspeed range for making the quickest (best turn rate), tightest (smallest turn radius) turn. This airspeed range is called corner velocity. At 330 knots and above in your F-16, you can pull 9 Gs (the structural limit of the aircraft). Below 330 knots, you do not have enough air going over the wings to get 9 Gs. As airspeed drops off below 330 knots, so does your ability to pull 9 Gs. Above 330 knots, you can always pull 9 Gs.



This sounds great at first, because it appears that all we have to do to optimally turn the jet is to fly faster than 330 knots. This is not true. Above 440 knots, you can still pull 9 Gs, but your turn radius increases dramatically while your turn rate actually goes down. This is because above 440 knots, the jet’s flight control system does not allow you to pull any *more* than 9 Gs. The extra airspeed then only hurts your ability to turn the aircraft.

The equations for turn rate and turn radius illustrate why this is the case. Why is not as important as knowing that there is an optimum airspeed for turning the jet. This airspeed is called corner velocity, and it is 330–440 knots in the F-16.

There is one other maneuvering concept that I will address before we blast off. This concept is called Specific Energy or P_s (pronounced “P sub S”). P_s is a concept that describes the energy or potential maneuverability of a fighter. *Falcon 4.0* was developed using the P_s curves of the F-16. These curves describe how well the F-16 will maneuver in terms of turn rate, turn radius and G.

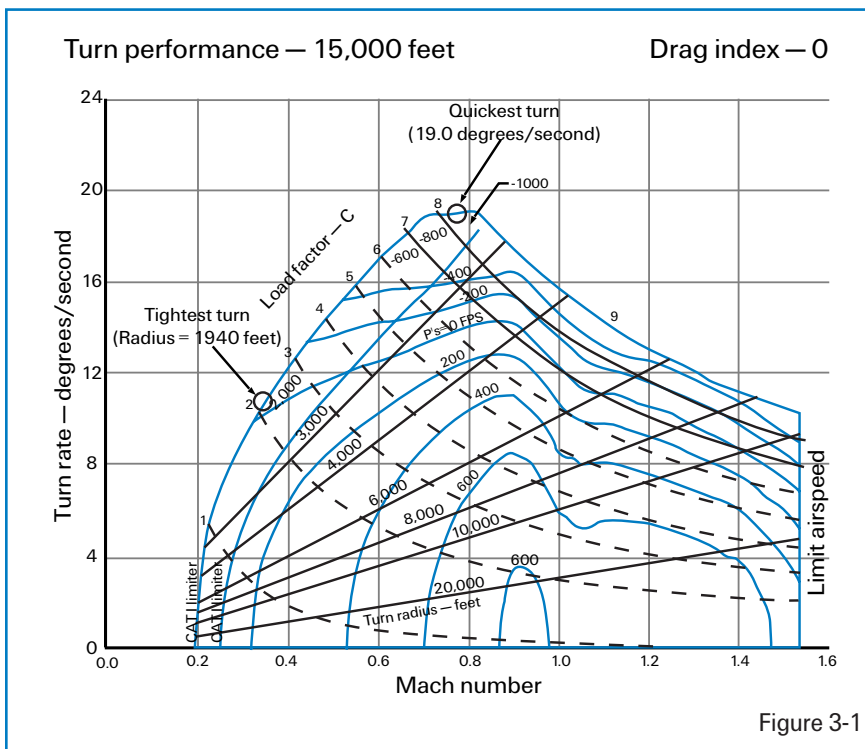

Figure 3-1

The P_s chart shows a series of fluid lines that represent specific energy states of the F-16 at an altitude of 15,000 feet and a drag index of zero. The drag index is determined by what is loaded externally on the jet. The zero P_s line is the area of the chart where the jet can maintain airspeed and altitude for a specific G load. The P_s lines that have negative values represent a flight regime in which the jet will lose either airspeed or altitude. The P_s lines with positive numbers represent where the aircraft has the potential to gain altitude or airspeed.

The next three training missions are designed to teach you how to turn the jet at, above and below corner velocity. They will also show you what will happen to your turn rate and radius if you do not turn at the proper airspeed.

TRAINING MISSION OVERVIEW

This mission allows you to practice a max G turn starting at corner airspeed and note the effects of airspeed and G on turn rate and radius. This mission will be easier to do with blackout disabled. Turn it off by selecting "No Blackout" in the Simulation setup screen.

INITIAL CONDITIONS

- ✦ Airspeed: 400 knots
- ✦ Altitude: 20,000 MSL (Mean Sea Level)
- ✦ Throttle Setting: Mid-range
- ✦ Configuration: Clean (landing gear up, flaps up and no brakes)

MISSION DESCRIPTION

In this training mission, your jet starts at 400 knots (within the corner airspeed range of 330–440 knots). Follow these steps to perform this maneuver:

1. Load training mission "03 Max Turn at Corner" from Tactical Engagement.
2. Press **[1]** on the top of the keyboard to bring up the HUD Only view.
3. Press **[F]** to record your flight using the ACMI feature. You should see "Recording" in red at the top of the screen to confirm that the recorder is on. You will use the recording later to review your flight.
4. Fly straight ahead for about 10 seconds. Note your heading before turning.
5. After about 10 seconds, go to full AB (Afterburner) by pushing the throttle all the way forward or by pressing **[Shift+]**. Note that the goal is to stay at the corner velocity of 330–440 knots. This may require you to reduce the Gs by easing off the joystick.



6. Roll the jet either right or left and set the wings between 75° – 85° of bank. Figure 3-2 shows the proper movement of the joystick and the corresponding response of the aircraft wings. The side-to-side movement of the joystick controls aircraft roll.
7. Pull all the way back on the stick to command the maximum G possible. Forward and backward movement of the joystick controls aircraft pitch as shown in Figure 3-3. Pitch essentially equates to aircraft Gs. Notice that you cannot pull max Gs at 20,000 feet and maintain corner velocity. If you pull more than 7 Gs in this turn, you will lose airspeed.

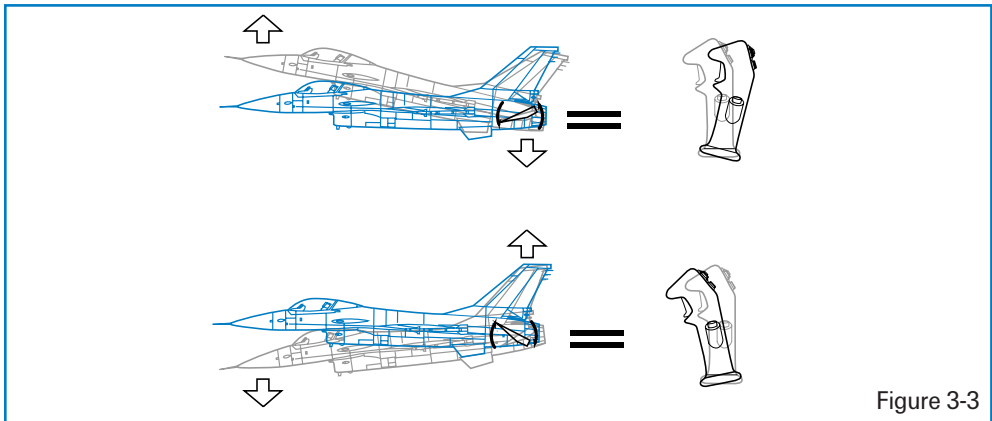
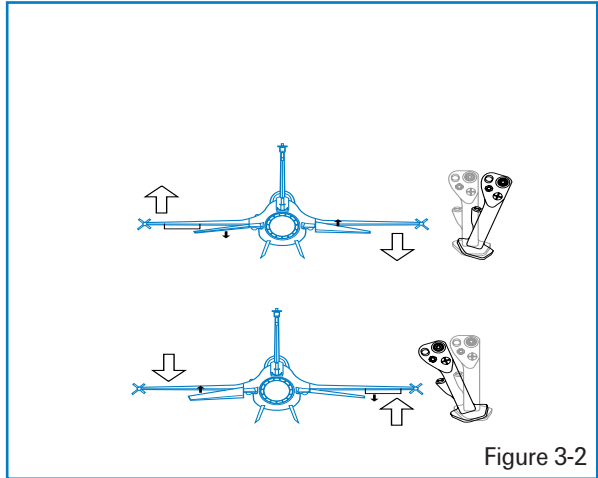

- Keep pulling around the turn, trying to maintain 330–440 knots, until you are back to your original heading (thereby making a full 360° turn).

Since this is a canned maneuver, you have the luxury of using the HUD to help you make this level turn. Figure 3-4 shows the HUD flight path marker, the HUD level line and your airspeed and altitude scales.

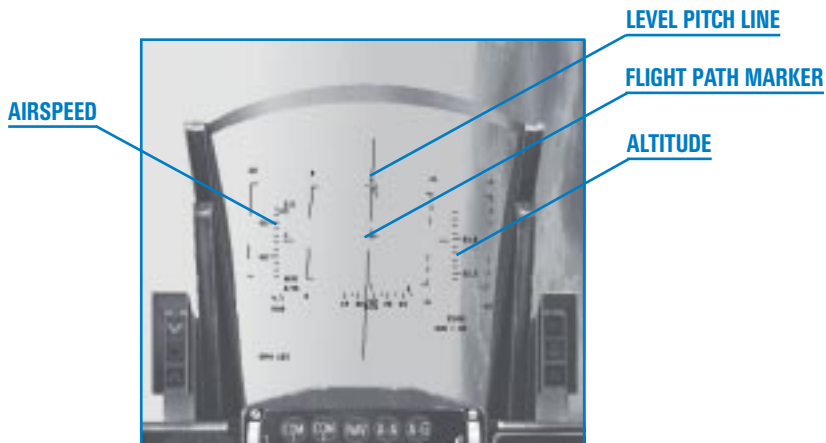

Figure 3-4

- During this turn, drag the flight path marker across the level pitch line in the HUD. The flight path marker is presented in the HUD to show the pilot where the aircraft is going. At speeds above 300 knots, it is very close to the nose of the aircraft. You control the HUD flight path marker with the joystick.

- Once you roll the jet 75°–85°, you can move the flight path marker by pulling back on the joystick. If the flight path marker is on the level pitch line in the HUD, the aircraft will stay level. If it gets above or below this line, then the aircraft will climb or dive respectively.

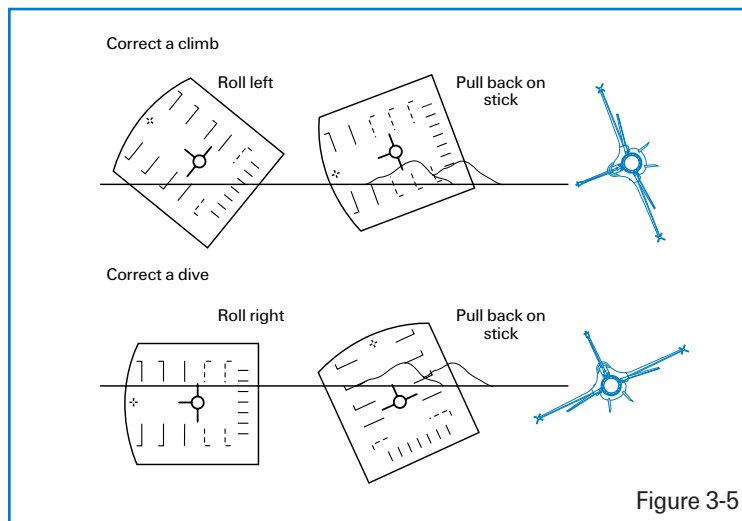

Figure 3-5



Figure 3-5 shows what do with the joystick in order to correct a climb or dive during this turn.

11. Press **[F]** to stop the ACMI recording.
12. Press **[Esc]** and then select “End Mission” to end the training mission.

One last point: in this training mission, we used the HUD to make a level turn. In most combat situations, however, your attention will be focused on the bad guys and you will not be able to use the HUD to make a perfectly level turn.

ACMI DEBRIEF

Select ACMI from the main menu on the left. Review the mission you just flew by clicking on the last tape in the list and then clicking on the Load button. After your ACMI tape loads, try the following ACMI option settings:

- ✦ Camera: Satellite
- ✦ Labels: Name, Airspeed, Turn Rate and Turn Radius Selected
- ✦ Wireframe Terrain
- ✦ Wing Trails: Maximum
- ✦ Vehicle Magnification: x8

Start the tape by pressing the Play button on the VCR controls. Use the view controls to view the turn from directly overhead. Use the small green F-16 icon to rotate your view. Use the arrow keys below to zoom in and out.

Review the turn rate and radius of your turn. It should take approximately 25 seconds to complete a 360° turn in your F-16. The turn radius for this turn is approximately 3,500–4,500 feet. The objective of this mission is to turn the jet at corner airspeed. Practice this mission until you can consistently execute the turn without gaining or losing more than 2,000 feet in altitude.

MISSION 4: MAX G TURN WELL ABOVE CORNER AIRSPEED

The objective of this mission is to observe the effects of trying to turn the jet at too high an airspeed. Training Mission 3 set you up to perform a max G turn at corner airspeed. Training Mission 4, however, will start at 650 knots which is well above the F-16’s corner airspeed of

330–440 knots. Remember from Training Mission 3 that corner airspeed is the speed at which the jet can make the quickest, tightest turn.

TRAINING MISSION OVERVIEW

In this mission, you will practice max G level turns starting well above corner airspeed. This lesson demonstrates the effects of trying to turn the jet at too high an airspeed. If you fly well above corner airspeed, the turn rate of the jet goes down and the turn radius increases dramatically. This poor turn rate affects your ability to point the nose, while the increased turn radius allows enemy fighters to easily fly inside your turn and stay on your tail.

INITIAL CONDITIONS

- ✦ Airspeed: 650 knots
- ✦ Altitude: 20,000 MSL
- ✦ Throttle Setting: Mid-range
- ✦ Configuration: Clean

MISSION DESCRIPTION

In this training mission, the F-16 begins at 700 knots, well above the maximum corner airspeed range of 330–440 knots. Even though the turn you make is at 9 Gs, note the increased turn radius and the reduced turn rate caused by this increased airspeed. This mission will graphically show why you will get spanked if you fly the jet too fast (above corner airspeed) in a turning fight.

You will execute the turn *exactly the same* as you did in Training Mission 3. Follow these steps to perform this maneuver:

1. Load training mission “04 Max Turn Above Corner” from Tactical Engagement.
2. Press **[F]** to record your flight using the ACMI feature.
3. Fly straight ahead for about 10 seconds. Note your heading before turning.
4. Roll the jet and set the wings between 75° – 85° of bank. Figure 3-2 shows the proper movement of the joystick and the corresponding response of the aircraft wings. The side-to-side movement of the joystick controls aircraft roll.



- Pull all the way back on the stick to command maximum G possible. Front and back movement of the joystick controls aircraft pitch as shown in Figure 3-3. Pitch essentially equates to aircraft Gs. Figure 4-1 shows the HUD flight path marker, the HUD level line, and your airspeed and altitude scales.

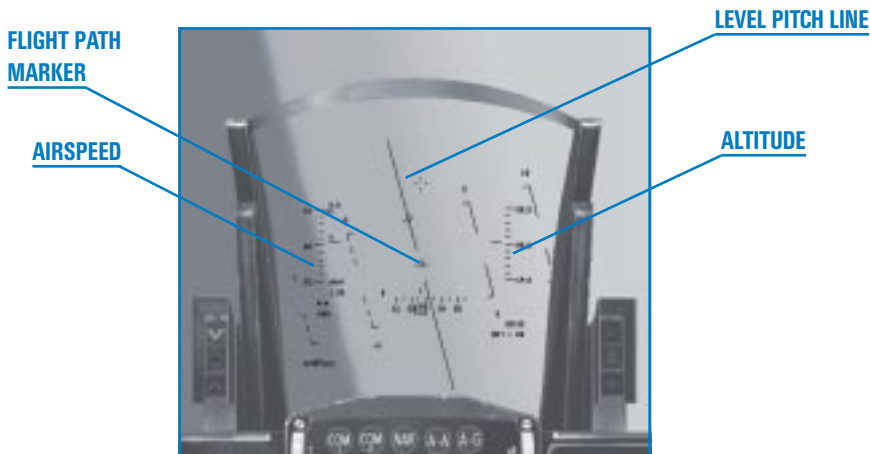

Figure 4-1

- During this turn, drag the flight path marker across the level pitch line in the HUD. Remember from the last training mission that the flight path marker shows the pilot where the aircraft is going. You control the HUD flight path marker with the joystick.
- Once you roll the jet 75° – 85° , you can move the flight path marker by pulling back on the joystick. If the flight path marker is on the level pitch line in the HUD, the aircraft will stay level. If it gets above or below this line, then the aircraft will climb or dive respectively. Refer to Figure 3-5 to use the joystick to correct a climb or dive during this turn.
- Press **[F]** to stop the ACMI recording.
- Press **[Esc]** and then select “End Mission” to end the training mission.

ACMI DEBRIEF

Select ACMI from the main menu on the left. Review the mission you just flew by clicking on the last tape in the list and then clicking on the Load button. After your ACMI tape loads, try the following ACMI option settings:

- ✦ Camera: Satellite

- ✦ Labels: Name, Airspeed, Turn Rate and Turn Radius Selected
- ✦ Wireframe Terrain
- ✦ Wing Trails: Maximum
- ✦ Vehicle Magnification: x8

Use the view controls to view the turn from directly overhead. Note the turn rate and radius of your turn. It should take approximately 35 seconds to complete a 360° turn in your F-16. The turn radius for this turn is approximately 6,500–7,000 feet. The objective of this mission is to see how flying too fast will adversely affect your turn performance.

MISSION 5: MAX G TURN WELL BELOW CORNER AIRSPEED

In this mission, you will see the effects of trying to turn an aircraft at slow airspeed. At low airspeeds, your turn radius is small but you suffer a very big turn rate reduction. This turn rate reduction hurts your ability to point the nose and shoot at enemy fighters.

INITIAL CONDITIONS:

- ✦ Airspeed: 200 knots
- ✦ Altitude: 20,000 MSL
- ✦ Throttle Setting: Mid-range
- ✦ Configuration: Clean

MISSION DESCRIPTION

This turn shows the effect of the F-16 being flown well under the minimum corner airspeed range of 330–440 knots. At 200 knots, the jet can only pull 2.5–4 Gs, which reduces the turn rate. The turn radius is small due to the slow airspeed, but it takes the aircraft much longer to get around the circle.

Execute the turn *exactly the same* as you did in Training Missions 3 and 4. Follow these steps to perform this maneuver:

1. Load training mission “05 Max Turn Below Corner” from Tactical Engagement.
2. Press **[F]** to record your flight using the ACMI feature.
3. Fly straight ahead for about 10 seconds. Note your heading before turning.
4. Go to full AB by pushing the throttle full forward or by pressing **[Shift+]**. At 200 knots and max AB, you should not accelerate in level flight because you are behind the “power curve.” At this airspeed and G, you need all of the jet’s thrust to maintain level flight.



5. Roll the jet and set the wings between 75° – 85° of bank. Figure 3-2 shows the proper movement of the joystick and the corresponding response of the aircraft wings. The side-to-side movement of the joystick controls aircraft roll.
6. Pull all the way back on the stick to command maximum G possible. Front and back movement of the joystick controls aircraft pitch as shown in Figure 3-3. Pitch essentially equates to aircraft Gs.

Since this is a canned maneuver, you have the luxury of using the HUD to help you make this level turn. Figure 5-1 shows the HUD flight path marker, the HUD level line, and your airspeed and altitude scales.

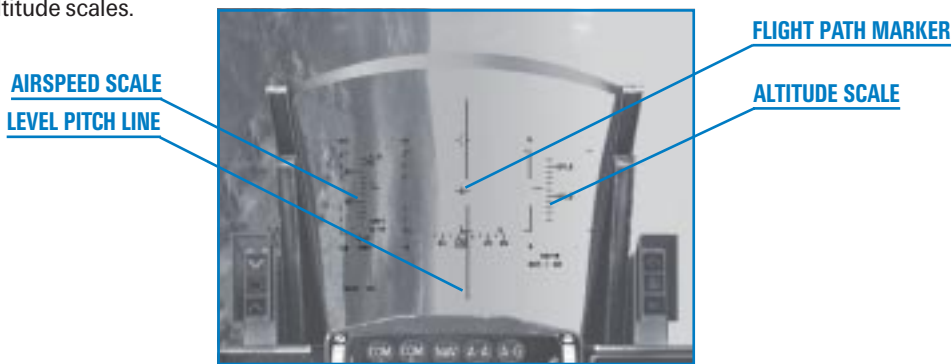

Figure 5-1

7. During this turn, drag the flight path marker across the level pitch line in the HUD. Once you roll the jet 75° – 85° , you can move the flight path marker by pulling back on the joystick. Refer to Figure 3-5 to use the joystick to correct a climb or dive during this turn.
8. Press **[F]** to stop the ACMI recording.
9. Press **[Esc]** and then select “End Mission” to end the training mission.

ACMI DEBRIEF

Select ACMI from the main menu on the left. Review the mission you just flew by clicking on the last tape in the list and then clicking on the Load button. After your ACMI tape loads, try the following ACMI option settings:

- ✦ Camera: Satellite
- ✦ Labels: Name, Airspeed, Turn Rate and Turn Radius Selected
- ✦ Wireframe Terrain
- ✦ Wing Trails: Maximum
- ✦ Vehicle Magnification: x8

Use the view controls to view the turn from directly overhead. After completing this turn, note the radius of the turn circle and the time it takes to complete a 360° turn. The turn radius for this turn is approximately 2,500 feet, but at 200 knots you can't move the nose at the same rate you can at corner airspeed. In fact, at 200 knots, it will take approximately 40 seconds to complete a 360° turn. This poor turn rate can get you killed. The objective of this mission is to see how flying too slow will adversely affect your turn performance.

MISSION 6: MINIMUM ALTITUDE SPLIT S

Use the Split S maneuver to simultaneously change your heading by 180° and descend to a lower altitude.

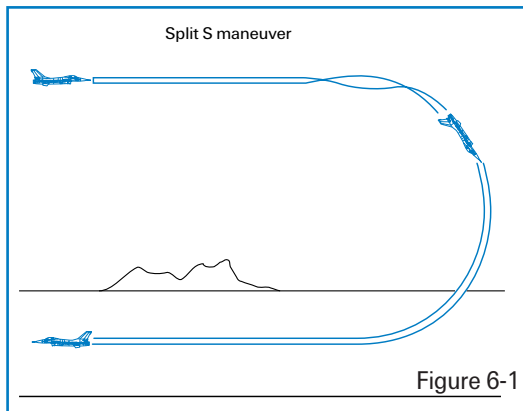

In the three preceding training missions, we turned the jet in a horizontal plane; in other words, we stayed level with the horizon while turning. The Split S maneuver is the first of a series of three training missions in which you will practice maneuvering the jet in the vertical plane. The vertical plane extends above and below the aircraft's current altitude.

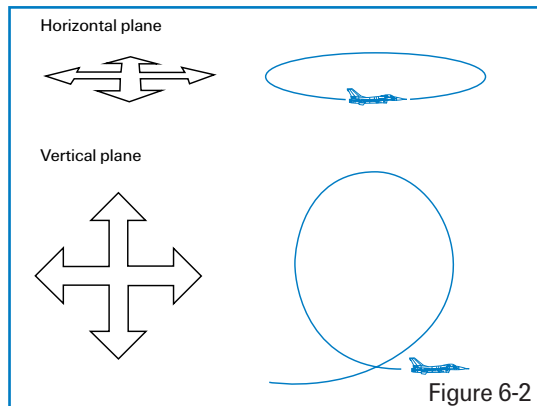

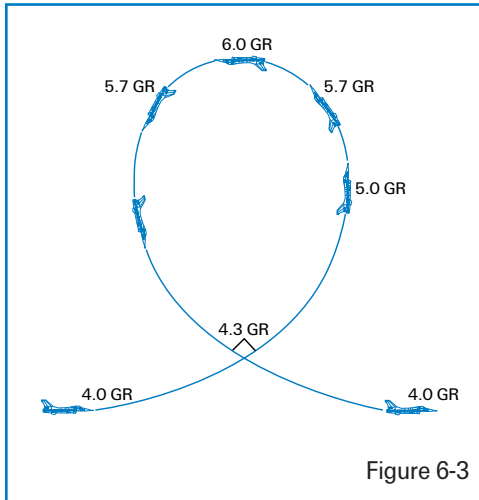

Figure 6-3

Since air combat is a three-dimensional affair, it is important to master turning the jet in both the horizontal and vertical planes. A big difference between the two different maneuvering planes is the effect of gravity on the jet. If you are turning the jet straight across the horizon in the horizontal plane, then gravity has relatively little affect on your turn performance. When you pull the nose up or down in the vertical, however, gravity becomes a player. Figure 6-3 illustrates “GR,” which stands for radial G (the G that the aircraft is actually adding to the turn rate and radius equation). In Figure 6-3, the cockpit G at the start of the pull is 5 Gs. Cockpit G is the G being felt and read out on the G meter in the cockpit. At the point the jet is pulling straight up, however, so the effective G or radial G is only 4 Gs. As the jet gets to 90° straight up or down, the radial Gs go to 5 Gs to match cockpit G.

Figure 6-3 shows that cockpit G is not equal to radial or turning G when maneuvering in the vertical. Remember that 2° per second is a significant turning advantage. The extra G you can get by placing your nose below the horizon when you turn can give you at least 2° per second turn advantage. Most of the time 1 GR equates to 3° – 4° per second.

You can see the concept of radial G even more clearly in Figure 6-4, in which both fighters are pulling the same cockpit G. Notice that the fighter with his lift vector below the horizon is turning more tightly. (Lift vector is an imaginary arrow that is projected from the top of the jet perpendicular to the aircraft’s wings.) What is not so obvious is that the fighter turning toward the ground is also moving, or rating, the nose faster.

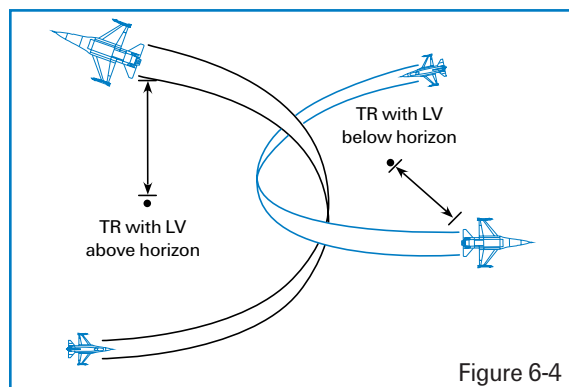

Figure 6-4

TRAINING MISSION OVERVIEW

In this mission, you will practice flying a Split S maneuver from 7,000 feet.

INITIAL CONDITIONS

- ✦ Airspeed: 400 knots
- ✦ Altitude: 7,000 AGL (Above Ground Level)
- ✦ Throttle Setting: Mid-range
- ✦ Configuration: Clean

MISSION DESCRIPTION

Use this maneuver to descend quickly to low altitude. To execute the maneuver, perform the following steps:

1. Load training mission "06 Min Altitude Split S" from Tactical Engagement.
2. Press **F** to record your flight using the ACMI feature.
3. At 7,000 feet, adjust the throttle to maintain 400 knots. Do not accelerate.
4. Roll the jet inverted. Figure 6-5 shows this inverted position.



Figure 6-5



5. Pull full back on the stick to command the maximum G possible. As the Gs increase during your dive, pull the throttle back slightly to maintain 400 knots. If you are still going too fast, extend the speed brakes by pressing **[B]**. Don't forget to retract them when you get to the proper airspeed. The maneuver is complete when the jet is in level flight heading in the opposite direction, as shown in Figure 6-6.
6. Press **[F]** to stop the ACMI recording.
7. Press **[Esc]** and then select "End Mission" to end the training mission.

This maneuver is easy to do if you control your airspeed. The common mistake made during a Split S is to ease up on the Gs and accelerate. If the airspeed builds, so will the turn radius—causing you to impact the ground.



Figure 6-6

7,000 feet is the lowest altitude from which you can comfortably perform a Split S at 400 knots. It can be done from as low as 5,000 feet, but you must be perfect or you will plant yourself into the terrain. After successfully completing the Split S maneuver from 7,000 and 400 knots, enter the training mission again and fly down to 5,000 feet and try it from this lower altitude.

In addition to experimenting at lower altitudes, you can also vary the airspeed from which you enter the Split S. For example, you should be able to Split S from 4,000 AGL at 300 knots, because you have a tighter turn radius at this airspeed than you do at 400 knots.

ACMI DEBRIEF

Select ACMI from the main menu on the left. Review the mission you just flew by clicking on the last tape in the list and then clicking on the Load button. After your ACMI tape loads, try the following ACMI option settings:

- ✦ Camera: Isometric
- ✦ Labels: Name, Airspeed and Altitude

- ✦ Altitude Poles On
- ✦ Wing Trails: Maximum
- ✦ Vehicle Magnification: x8

Use the view controls to view the turn from an isometric angle or a side view of the jet.

MISSION 7: HIGH-SPEED OVER-THE-TOP MANEUVER

In this mission, you will practice maneuvering over the top or up in the vertical. This training mission and the one that follows will help you gain more confidence and control when climbing in the jet. Variations of this maneuver are used often in air combat, and it is important to note your entry and exit airspeed and the altitude that you gain during the maneuver.

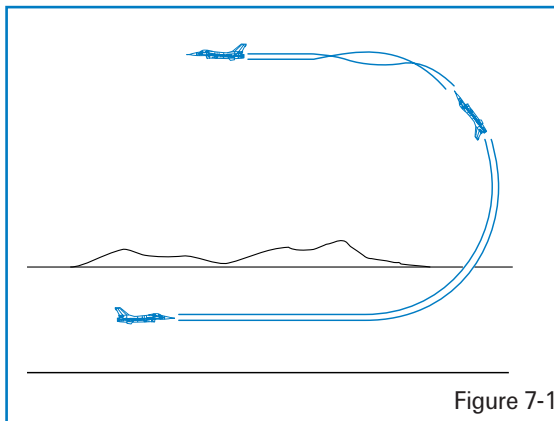

Figure 7-1

TRAINING MISSION OVERVIEW

Practice high-speed over-the-top maneuvers.

INITIAL CONDITIONS

- ✦ Airspeed: 400 knots
- ✦ Altitude: 20,000 MSL
- ✦ Throttle Setting: Mid-range
- ✦ Configuration: Clean



MISSION DESCRIPTION

In this mission, you will fly the jet over the top and end up at a higher altitude heading the opposite direction. A key to this maneuver is to get the jet pointed up away from the earth and to note your airspeed and the altitude you've gained. Once the jet is going straight up, the pilot has several options if the maneuver was started at high speed. When you get going straight up, you can pirouette the jet. The pirouette is used to maneuver the jet in relation to an adversary. After practicing a straight pull up and over, try doing the mission again and pirouetting the jet and rolling off in another direction.

To execute the basic maneuver:

1. Load training mission "07 High-Speed Over Top" from Tactical Engagement.
2. Press **[F]** to record your flight using the ACMI feature.
3. From the starting entry conditions, start a wings-level 6 G pull up.
5. Place the throttle in full AB.
5. Continue the pull all the way over the top, through the vertical and back toward the horizon, as shown in Figure 7-3.
6. As the aircraft approaches level flight inverted at the top of the maneuver, ease up on the G and come out of AB. The view should look like Figure 7-4.
7. Now roll back upright and note your airspeed and altitude. You should be at approximately 26,000 feet and 200–250 knots.



Figure 7-3

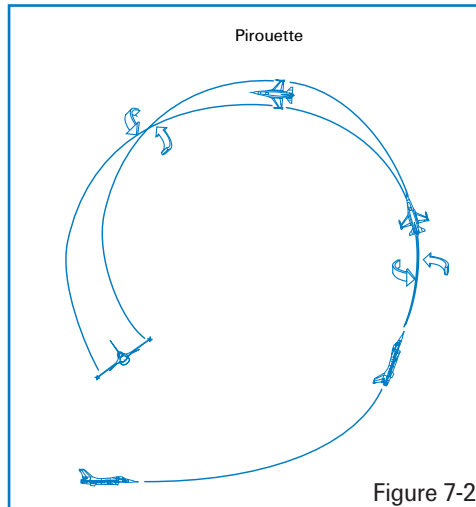

Figure 7-2



Figure 7-4

To perform a pirouette during this over-the-top maneuver, follow these steps:

1. From the starting entry conditions, start a wings-level 6 G pull.
2. Place the throttle in full AB.
3. Continue the pull all the way over the top, but stop when you are going straight up. Figure 7-5 shows this position with the jet going straight up, 90° from the horizon.



Figure 7-5

4. Once the aircraft is established at 90° nose high, *relax back stick pressure* and then roll the jet 90°. *Be sure not to roll and pull at the same time.* Use the heading tape to determine your orientation. Your heading should change by 90°. Figure 7-6 shows this pirouette.

5. The maneuver should end with the jet heading 90° from the original heading at this new higher altitude.

6. Press **[F]** to stop the ACMI recording.

7. Press **[Esc]** and then select "End Mission" to end the training mission.

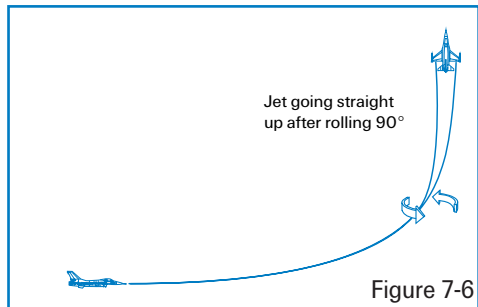

ACMI DEBRIEF

Select ACMI from the main menu on the left. Review the mission you just flew by clicking on the last tape in the list and then clicking on the Load button. After your ACMI tape loads, try the following ACMI option settings:

- ✦ Camera: Isometric
- ✦ Labels: Name, Airspeed, Heading and Altitude Selected
- ✦ Altitude Poles



- ✦ Wing Trails: Maximum
- ✦ Vehicle Magnification: x8

Use the view controls to view the turn from an isometric angle to a side view of the jet. The object of this mission is to get a feel for maneuvering the jet in the vertical at high speed.

MISSION 8: LOW-SPEED OVER-THE-TOP MANEUVER AND DEPARTURES

In this mission, you will practice maneuvering the jet in the vertical at low airspeed. To maneuver a jet, you need airspeed. Low speed maneuvering against an enemy aircraft in the vertical is a critical combat skill that is difficult to master.

Maneuvering in the vertical at low speed is very different than at high speed, because your F-16 might deep stall. A deep stall is a condition in which the F-16's nose gets hung up and you're essentially out of control. Figure 8-1 displays a conventional aircraft with its center of gravity and the center of lift. Without getting into the math on this stuff, this aircraft is stable because the center of lift is aft of the center of gravity.

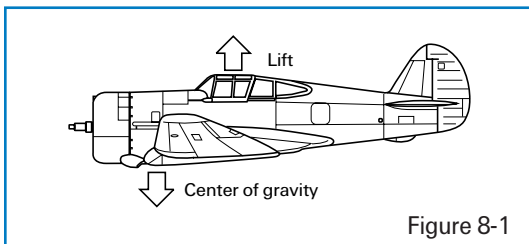

Figure 8-1

Such a design is stable because if the aircraft is maneuvered or encounters a condition that takes it out of a steady state flight condition, the aircraft has a tendency to recover back to that steady state condition. The F-16 has what is called "relaxed static stability." In other words, it is designed to be very close to being unstable. Instability is desirable in fighters

because the less stable an aircraft is, the more maneuverable it is. Relaxed static stability means simply that if the jet is maneuvered or encounters conditions that take it out of steady state flight, then it may not recover back to the steady state condition very easily. The F-16's FLCS (Flight Control System, pronounced "flickus") keeps the jet from going out of control by placing "limits" on what the flight controls will let the pilot do. Sometimes (especially at slow speeds), the FLCS will not allow certain control inputs that are commanded by the pilot. The FLCS works well as long as the pilot only "assaults" one limiter at a time, that is commands a control input that requires the limiter in a given axis to do its job and prevent further movement of a specific flight control.

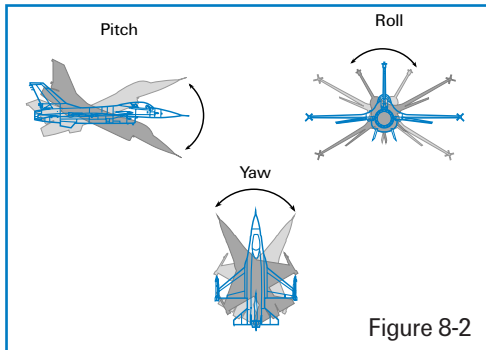

Figure 8-2

The F-16 moves through the air along three axes of movement: pitch, roll and yaw. Pitch is movement around the horizontal axis of the aircraft. You experience it as the nose moving up and down. Roll is movement along the long axis of the aircraft. You experience a roll by seeing the horizon in front of you. Yaw is movement around the vertical axis of the aircraft. You experience it as the nose moving left and right from your point of reference as the pilot.

The bottom line on the F-16 is that the FLCS only works well in limiting the flight controls and preventing trouble one axis at a time. If two limiters are assaulted at the same time, the result can be like a carnival ride. When you put a fighter out of control, it is called a *departure*. To keep from departing the aircraft, you must be smooth at slow speed and watch what you do with the stick. Recall that in the very first training mission, we flew a HART maneuver and that the F-16's low speed warning horn comes on as a function of pitch and airspeed (nose high pitch and slow airspeed). Once you hear the horn, you are in danger of departing the F-16 if you are not careful with the controls. If you do jerk the jet around, you may depart. Once the aircraft is departed, one of three things will happen: the jet will self-recover, it will end up in an upright deep stall or it will end up in an inverted deep stall. In the F-16, you will find yourself in a deep stall most of the time.

A deep stall is a condition of flight in which the pilot is no longer able to move the jet's control surfaces. In a departure, the FLCS acts like HAL the computer from the movie *2001*: it takes control of the aircraft and shuts you out of the control loop. Unfortunately, the FLCS does not do anything very useful for you. In a deep stall, the jet will fall toward the ground like a leaf with the nose bobbing up and down with the AOA pegged at 30° . If you are lucky enough to be in a upright deep stall, the FLCS will at least zero out your yaw rate and you will not be spinning. In the inverted deep stall, however, the FLCS won't do diddly. In an inverted deep stall, the AOA will be pegged at -5° and the jet will be spinning.

This training mission will teach the correct techniques for slow speed flying in the vertical. I will also give you the correct steps to recover from both upright and inverted deep stalls.

TRAINING MISSION OVERVIEW

Practice slow speed over-the-top maneuvers.

INITIAL CONDITIONS

- ✦ Airspeed: 300 knots
- ✦ Altitude: 20,000 MSL



- ✦ Throttle Setting: Mid-range
- ✦ Configuration: Clean

MISSION DESCRIPTION

This maneuver shows the capability of the aircraft to maneuver in the vertical, even when starting at slow speeds. Getting the jet in the vertical at slow speeds requires finesse. Just pulling the jet straight up and down toward the horizon is not difficult, but be careful when doing a pirouette at a slow speed.

To execute the basic maneuver:

1. Load training mission "08 Low-Speed Over Top" from Tactical Engagement.
2. Press **[F]** to record your flight using the ACMI feature.
3. From the starting entry conditions, start a wings-level 4 G pull.
4. Place the throttle in full AB.
5. Continue the pull all the way over the top, through the vertical and back to 10° above the horizon as shown in Figure 8-3. Max G at the top is just over 1 G.

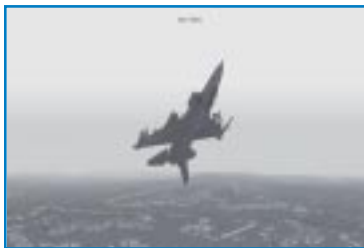

Figure 8-3

6. Ease up on the G. The view should look like Figure 8-4.

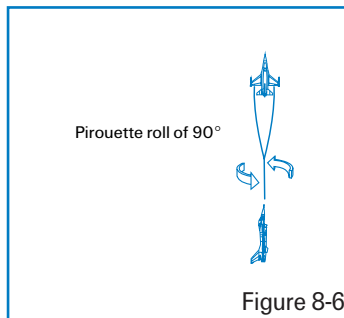
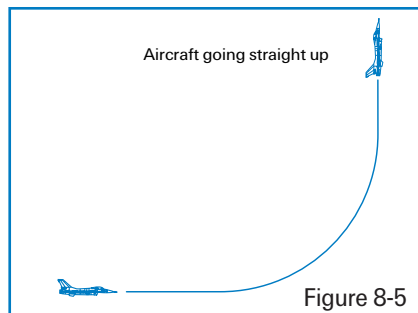

Figure 8-4

- Now roll back upright to level flight and note your airspeed and altitude. You should be at approximately 27,000–28,000 feet and 100–200 knots. The aircraft will be very difficult to control in both roll and pitch. This lack of control authority can be attributed directly to your slow airspeed. Contrast this with the previous training mission, in which you reached the same spot but with 100 knots more airspeed.

Next you will practice doing a pirouette. This maneuver is difficult to perform at slow speed but can be accomplished with some practice. To perform a pirouette during this over-the-top maneuver, follow these steps:

- From the starting entry conditions, start a wings-level 4 G pull.
- Place the throttle in full AB.
- Continue the pull all the way over the top, but stop when you are going straight up. Figure 8-5 shows this position with the jet going straight up, 90° from the horizon.
- Once the aircraft is established at 90°, *relax back stick pressure* and then roll the jet 90°. *Be sure not to roll and pull at the same time.*
- When you have established your wings in the desired plane, start a pull toward the horizon. Figure 8-6 shows this pirouette.





6. The maneuver should end with the jet heading 90° from the original heading at this new higher altitude.
7. Press **F** to stop the ACMI recording.
8. Press **Esc** and then select “End Mission” to end the training mission.

Practice this maneuver until you can comfortably pirouette the jet in the vertical after starting at a slow speed.

DEEP STALLS

What happens if you ham fist yourself into a departure and a deep stall? This section will tell you how to recover from a deep stall—but first a little background on the procedures. Every month I am required to fill out a CAP (Critical Action Procedures) sheet. We have several emergencies that require F-16 pilots to quickly perform memorized steps. To keep these steps fresh in our minds, we have to write them down from memory every month. The deep stall is one of these critical emergencies. So what procedures do you think we are going to use in *Falcon 4.0* to recover from a deep stall? You guessed it: the actual F-16 CAP. I'll just add some commentary about how to use the game-specific controls.

So you can get *out* of a deep stall, I'll tell you how to purposefully get yourself *into* one. You'll deep stall when you get your jet slow, nose high, and you assault the flight control limiters. First, get the nose of the jet up to 70° – 90° and pull the power back to idle. Next, wait for the low speed warning horn. When it comes on, pull back hard on the stick while rolling the jet as fast as possible. You must perform this maneuver quickly to get the jet to depart controlled flight and enter a deep stall. You are in a deep stall when you feel like the jet is fluttering like a leaf but falling like a brick. If you cannot control the jet and keep asking yourself “What’s going on?” you are in a deep stall.

If you have confirmed that you are in a deep stall (loss of pitch and roll control, and AOA pegged at 30° in an upright or -5° negative when inverted), execute the following procedures:

1. Controls: Release

In this step, all you do is release the controls. In other words, take your mitts off the joystick. By doing this, you give your jet the best chance to self-recover. This does not mean that you should release the controls when you hear the horn, but it does mean that when you see the AOA pegged and that the nose of the jet is no longer tracking, release the controls.

2. Throttle: Idle

This step is pretty easy. Use your throttle or press **Shift** **-** to bring the throttle back to idle.

If the jet is inverted:

3. Rudder: Opposite yaw direction

If you are in an upright deep stall, you can skip this step since the FLCS will automatically dampen your yaw rate. If you are inverted, though, you have to arrest your yaw rate by stepping on the rudder that is opposite your yaw or spin direction. If you are yawing left, step on the right rudder or press .

4. MPO Switch: Override

The MPO (Manual Pitch Override) switch must be engaged in order to override the FLCS and gain control of the aircraft flight controls. To engage the MPO, press . Use the MPO switch to get into override mode.

5. Stick: Cycle in phase

This is the critical part of the procedure, because you have to put those same big mitts back on the joystick and fly this beast out of trouble. You must get in phase with the pitch bobbing (oscillation of the nose) and rock the jet out of the deep stall. Pull back on the stick (or push if you are inverted) until the nose comes up. The nose will come up momentarily and then start back down again. As soon as the nose starts to fall towards the horizon, get in phase with the aircraft and push (or pull if you are inverted) to bring the nose down toward the ground. The nose will no doubt rise again, and you will have to repeat the process at least one more time. *Do not just push and pull on the stick.* This will not get you out of a deep stall. You must get in phase with the jet. If you push or pull the nose down toward the horizon and the nose stays low, do *not* pull the nose back up. You know you have recovered from a deep stall when the nose stays down. When this occurs, hold it down until you get to 200 knots. At 200 knots, start a gentle pull out. If you are recovering from an inverted deep stall, do not roll upright and pull until you get to 200 knots.

ACMI DEBRIEF

Select ACMI from the main menu on the left. Review the mission you just flew by clicking on the last tape in the list and then clicking on the Load button. After your ACMI tape loads, try the following ACMI option settings:

- ✦ Camera: Isometric
- ✦ Labels: Name, Airspeed and Altitude Selected
- ✦ Altitude Poles
- ✦ Wing Trails: Maximum
- ✦ Vehicle Magnification: x8

Use the view controls to view the plane from a side view.

CHAPTER

3



***LANDING AND
NAVIGATION***

The following missions will teach you how to land the F-16, including a how to perform an instruments landing and a “flameout landing.” You’ll also learn the basics of navigation, including how to use steerpoints.

MISSION 9: LANDING FROM 10 NM OUT ON FINAL

This training mission will teach you how to land the Falcon. The F-16 is not hard to land if you do three things: configure the aircraft correctly, get close to a 2.5° glide path and, last but not least, control your airspeed. In this training mission, you will start lined up on final approach but will have to accomplish these three things (and one more) in order to get the jet on the ground safely.

TRAINING MISSION OVERVIEW

You will practice landing the aircraft from 10 nm out, lined up on the final approach course.

INITIAL CONDITIONS

- ✦ Airspeed: 200 knots
- ✦ Altitude: 2,000 AGL (Above Ground Level)
- ✦ Throttle setting: Mid-range
- ✦ Configuration: Gear up and clean
- ✦ Position from the runway: 10 nm out, on the runway centerline
- ✦ Weapons Mode: NAV

MISSION DESCRIPTION

This mission starts with you heading toward the runway, 10 nm out. The jet is at 200 knots in level flight with the gear up.

Perform the following steps to land the aircraft:

1. Load training mission “09 Landing Final Approach” from Tactical Engagement.
2. Line the flight path marker up with the 0° pitch line in the HUD to maintain level flight.
3. Get permission to land from the tower. To avoid being placed in the normal ATC (Air Traffic Control) pattern, press **[T]** and select “Declaring an emergency.” ATC will tell you which runway they have cleared to deal with your emergency. Make note of the runway assigned to you. Use the assigned runway to avoid other aircraft.



4. Make sure your airspeed is below 300 knots.
5. Lower the landing gear by pressing **G** or by clicking on the gear handle on the lower left cockpit console. To switch to this console, press **←** and **↓** on the numeric keypad from the 2-D Cockpit view.



Figure 9-1

Notice that when the gear handle is placed down, the red light in the gear handle will come on indicating that the gear are in transit. When the red light goes out, this means that the gear are down. The red light illuminates whenever one or more of the landing gear are not in the position that corresponds to the gear handle. When the gear handle is placed down, the light comes on until the gear are locked in the down position. When the gear handle is raised, the red light comes on again until the gear are up and locked. If the red light stays on, you have a problem with the landing gear.

Look also at the three green lights above the gear handle to check that the gear are down and locked. If one of these lights is not illuminated after the gear handle is down, this indicates a problem with the gear. The lights are arranged in a triangle with the top light indicating the nose gear and the left and right lights representing the main gear.

6. Once the gear are confirmed down and locked, start slowing the jet to 160 knots by pulling some power off. Set your fuel flow to about 2,300 pounds/hour or adjust your engine to 84% on the RPM gauge. To check your airspeed, look at the caret on the left side of the HUD (the horizontal line). The sideways "V" on the HUD is the caret for TOS (Time Over Steerpoint). Do not try to chase the TOS caret.

FUEL FLOW GAUGE



RPM GAUGE

Figure 9-2

Be sure to watch your airspeed closely during this phase of flight so you don't get too slow. Do not get below 160 knots until you are on the glide path and using the AOA (Angle of Attack) bracket.

7. Again, while you are slowing down, be sure to keep the flight path marker on the level line, 0° of pitch, as shown in Figure 9-3.

0° PITCH LINE

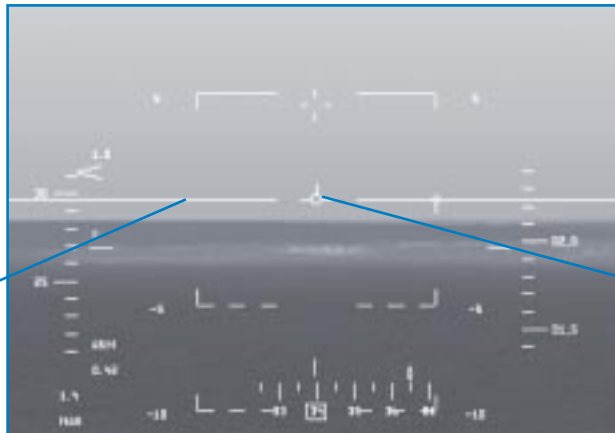

**FLIGHT
PATH
MARKER**

Figure 9-3



8. As you look out on the horizon, you will see two wide strips and at least one narrow one. The wide strips are the two parallel runways, while the narrow strips are the taxiways. If you are on the left side of the runway, gently bank right until the runway is aligned below the airspeed tape on your HUD. If you are lined up too far to the right of the runways, turn to put the runways under your altitude tape on the HUD. Keep flying level until you can see down the center of the runway. When you are aligned with the runway, turn toward it until you are flying along the centerline. You can press **[L]** to take a closer look at your alignment. Don't forget to press **[L]** again to return to normal view before continuing the approach.
9. When the runway threshold (the close end of the runway) reaches 3° down in the HUD, extend the speed brakes by pressing **[B]** and place the flight path marker on the runway threshold. The runway threshold is the dark area at the close end of the runway. Figure 9-4 shows the jet in level flight with the runway threshold 3° down in the HUD.

**RUNWAY
THRESHOLD**

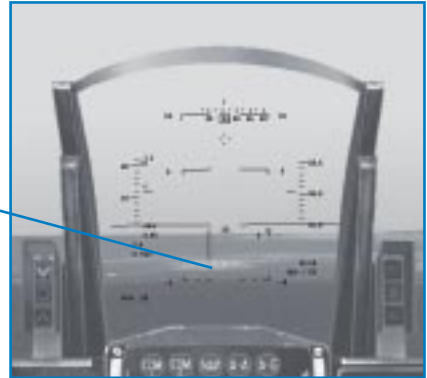

Figure 9-4

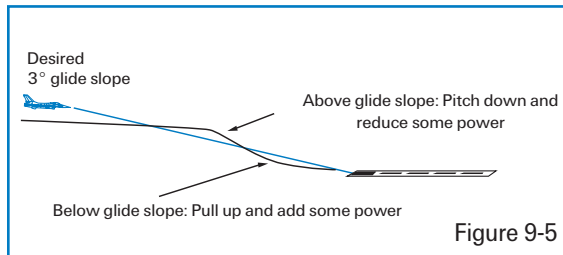

Figure 9-5

Figure 9-5 shows the jet at the proper airspeed on a 3° glide path. You will not need to make a big power change since 2,000 pounds/hour will hold approximately 160 knots with the gear down and the speed brakes open when the jet is descending.

Let's look at the landing symbology in the HUD. When the landing gear are down, an AOA bracket will appear in the HUD.

You can instantly see the jet's AOA by noting the position of the flight path marker in relation to this bracket in the HUD. The correct angle of attack for an approach is 11° . To fly the correct approach airspeed, keep the flight path marker at the top line of the bracket.

10. Once you are pointed at the runway threshold, use power to control your airspeed and keep the flight path marker on the end on the runway. Remember that the top of the bracket is 11° and the bottom is 15° . Use power to fly at 11° AOA.

Now let's talk more about the AOA bracket. It's OK to let the flight path marker drift down to the middle of the bracket (13° AOA) during your approach, but do not let it get to the bottom of the bracket (15° AOA). It is difficult to control the aircraft at 15° AOA and get it on the runway safely. In addition, if you hit the runway too hard while landing at 15° AOA, you can scrape the speed brakes.

- As the jet gets down to 100 feet above the runway, it is time to flare. A flare is simply a maneuver to decrease your sink rate in order to gently place the jet on the runway. To flare the F-16, slowly shift your aimpoint from the threshold down to the far end of the runway. Do this by pulling back very gently on the stick to move your flight path marker down the runway towards the opposite end of the runway. As you pull slightly back on the stick, watch the flight path marker slowly creep up. Make sure that the flight path marker stays below the edge of the far end of the runway during this maneuver. Keep the airspeed at about 130 knots until you hear the tires touch down. The throttle should be brought slowly back to idle as you flare.

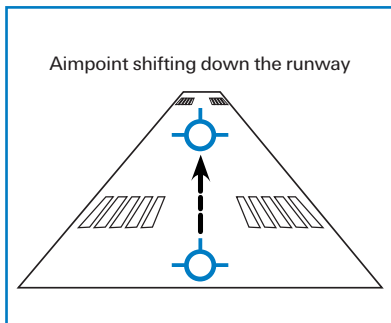

If you try to flare when the jet is too fast or you don't pull the power back as you flare, you will balloon or start to climb away from the runway. The other extreme is to come in too slow and drop the jet onto the runway. In either case, push the power up and go around for another try.

- Once you touch down and hear the tires screech on the runway, gently pull the gun cross up above the 10° pitch line on the HUD to aero brake the aircraft. In the F-16, the body of the aircraft is used as a giant

speed brake. The gun cross is used as a pitch reference during the aero brake because the flight path marker gets unreliable once you touch down on the runway. When the jet finally slows below about 100 knots, the nose will fall through to the runway. Again, be sure the throttle is in idle (all the way back).

Landing the jet will take some practice since *Falcon 4.0* so faithfully reproduces the real F-16. I have flown A-7 Corsairs, F-4 Phantoms and two jet trainers that are all easier to land than the F-16. You'll get the hang of it with some practice, though, so keep trying until you get the "sight picture" down. Use the above procedures as a starting place to make repeated practice approaches. Each pilot has his or her own techniques, and you will soon develop your own. The above procedures are what I use in both *Falcon 4.0* and the real jet.

To review this important concept:

- Use the joystick to point the flight path marker on the middle of the runway threshold.
- Use the throttle to adjust your airspeed to fly at 11° AOA.
- Hold this picture until you get down to 100 feet.



MISSION 10: LANDING FROM A BASE LEG POSITION USING THE INSTRUMENTS

In this mission, we will practice combining the cockpit instruments with the HUD to line up on the runway and fly an approach and landing. The primary cockpit gauge involved is the HSI (Horizontal Situation Indicator), which is used to position the aircraft on final approach when you cannot see the runway due to weather or darkness. To view the HSI from the 2-D Cockpit view, look down in the cockpit by pressing  on the numeric keypad.



Figure 10-1

The HSI provides a plan view of your position in relation to a selected TACAN (Tactical Air Navigation) station and course. You can select TACAN stations which are located on airfields. These stations can be dialed up along with an inbound course. This makes the HSI a god's-eye or overhead view of your position in relation to the approach path. The TACAN station emits an electrical signal that can be viewed by the pilot as spokes on a giant wheel. Since the TACAN station is near the runway, the pilot can dial in the radial or spoke that lines up with the runway inbound course and use the HSI to line up their aircraft with the runway.

A fixed aircraft symbol in the center of the gauge represents your aircraft. The face of the HSI is a compass card that displays the aircraft's magnetic heading at the 12 o'clock position. Figure 10-1 shows the 12 o'clock position on the HSI heading dial that displays aircraft heading.

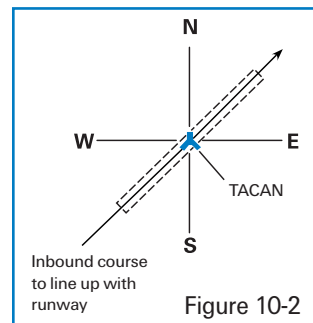

Figure 10-2

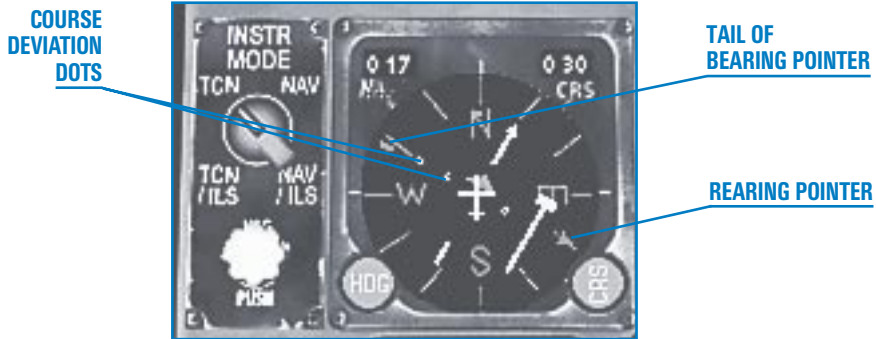

Figure 10-3

The other important part of the HSI is the CRS (Course) knob, which allows you to set a course in 5° increments into the course window. The course window sets a course that is shown on the dial by the CDI (Course Deviation Indicator), which is a needle that deflects to show your position from the selected course. Figure 10-3 shows this needle along with another important indicator, the bearing pointer, which points to the selected TACAN station. Along with the bearing pointer needle is a corresponding tail of the bearing pointer.

In the center of the HSI are a series of dots that show how many degrees the needle is deflected from the desired course. Each dot represents either 5° or 2.5°, depending on which mode the HSI is in. When the needle is fully deflected, the aircraft is 10° or greater from the selected course.

To the left of the course window is the range window, which shows nautical miles to the selected TACAN station or navigation steerpoint, whichever is selected. One fundamental feature of the HSI is that it does not exclusively display TACAN data. The HSI also displays navigation steerpoints and ILS (Instrument Landing System) information. The F-16 pilot can navigate using TACAN stations or INS (Inertial Navigation System) steerpoints. INS steerpoints are specific places in the world that are loaded into the aircraft's INS. The INS uses a laser gyroscope to determine where the aircraft is at all times.

The pilot can then put steerpoints into the system and get steering to those destinations in the HUD and HSI. The HSI displays this information in the same way that it displays TACAN data.

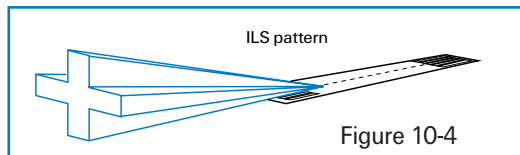

Figure 10-4

ILS data can also be displayed on the HSI. The ILS is used for precise azimuth and glide slope steering to the runway during night or adverse weather. The ILS signal radiates from a series of antennas located near the runway. Figure 10-4 shows the ILS antenna radiation pattern. Aircraft use onboard equipment to pick up this radiated signal and steer toward the intersection of the radiated pattern. This creates a path in the sky down toward the runway.



When the ILS is selected, ILS steering appears in the HUD to match the HSI. One limitation of the ILS is that you must be close to the airport (approximately 20 miles) and near the antenna pattern in order to receive ILS steering. For this reason, it is best to use the TACAN first and then switch to the ILS when you are within 20 miles and near the inbound course.

In summary, the HSI can display course information along with aircraft position from a selected TACAN station, navigation steerpoint or ILS course. Several combinations of the above data sources can be selected and displayed on the HSI. Below the HSI is the Instr Mode knob, which has four settings: NAV, NAV/ILS, TCN (TACAN) and TCN/ILS.

Instr Mode Setting	Source for Course Data Displayed	Source for Range Data Displayed	Degrees of Deflection per Dot
TACAN	TACAN station	TACAN station	5°
NAV	INS steerpoint	INS steerpoint	5°
ILS/TACAN	ILS signal	TACAN station	2.5°
ILS/NAV	ILS signal	INS steerpoint	2.5°

TRAINING MISSION OVERVIEW

You will practice intercepting a final approach course and landing the aircraft, starting 15 nm out positioned on a base leg. This base leg is where the jet is heading 90° to the final approach course. This training mission is designed to teach you how to fly an ILS approach using the HSI as a primary reference.

INITIAL CONDITIONS

- ✦ Airspeed: 200 knots
- ✦ Altitude: 2,000 AGL
- ✦ Throttle setting: Mid-range
- ✦ Configuration: Gear up and clean
- ✦ Position from the runway: 15 nm out, 90° from the runway centerline
- ✦ Weapons Mode: NAV

MISSION DESCRIPTION

When the mission starts, the jet is approaching the final approach course from a 90° angle. You will already be in ILS mode, but when you are returning from a real mission, you may have to navigate back to the runway using TACAN and then switch to ILS. The HSI will have the runway heading dialed in and will show your position approaching the inbound course. Figure 10-5 shows you an overhead view of your position from the runway.

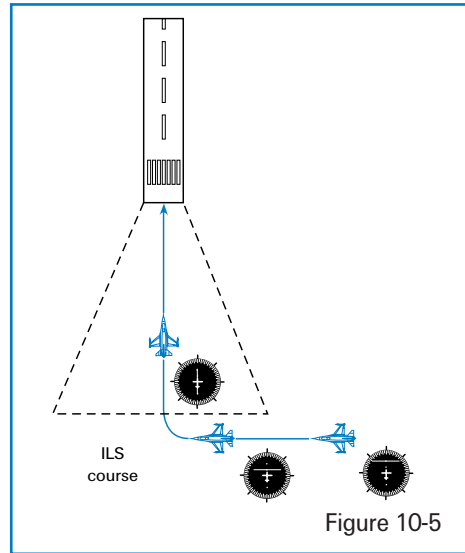

Perform the following steps to fly the approach:

1. Load training mission "10 Instruments Landing" from Tactical Engagement.
2. Ensure the flight path marker is on the level line (0°) line in the HUD.
3. Set the fuel flow to 1,200–1,300 pounds/hour. Figure 10-6 shows the correct position with the fuel flow gauge set. This fuel flow will keep the jet at approximately 200 knots with the gear up in level flight.
4. Press **[Shift][P]** to freeze the sim.
5. Now you need to set your TACAN channel for the Kunsan TACAN. There are two ways to set the TACAN: the Upfront Controls or the Backup system. We will use the Backup controls for this mission. First, press **[2]** for the 2-D Cockpit view and then press **[←]** on the numeric keypad to look left. Flip the Backup/UFC switch to Backup. Next, set the TR/A-A TR switch to the TR (Transmit Receive) position. Finally, set the channel selector to "101X" by clicking on the numerals in the TACAN channel display.



Figure 10-6



6. Look right in the cockpit by pressing \rightarrow on the numeric keypad. Switch the Instr Mode switch to TCN/ILS. Next, set 340° as the inbound course for the Kunsan ILS. You can get the TACAN channel and runway information from **Appendix C: Airport Maps**. Use the course dial (CRS) to change the numbers in the window. I know this is a lot of work, but you wanted real and you got real. This is just the way it is in the jet, so hang in there.
7. Unfreeze the simulation by pressing $\text{Shift} \text{P}$.
8. Watch the CDI (Course Deviation Indicator) on the HSI. As soon as it starts moving toward the aircraft symbol, start a 30° bank turn toward the runway. The bearing pointer in the HSI will be pointing toward the runway.

To make this turn precisely, use the ADI (Attitude Director Indicator), the round ball in the center of the instrument panel. It displays aircraft pitch and roll information. The ball represents the earth, and the horizontal line through the ball is the horizon line. The wings of your aircraft are represented as a fixed line in the center of the display. The line remains fixed when you roll or pitch the aircraft. The tick marks on the side of the ADI represent degrees and are a backup to the HUD. In addition, the ADI is the only precise way of setting a bank angle when you cannot see the horizon. Figure 10-7 shows the ADI displaying a 30° banked turn.

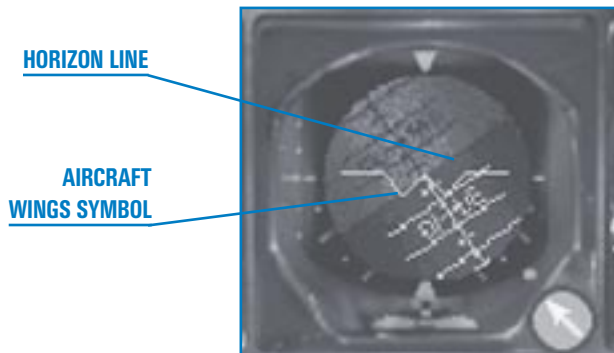

Figure 10-7

9. Roll wings level when the CDI needle is centered in the HSI display. The bearing pointer should be centered at 12 o'clock, with the runway on your nose. Figure 10-8 shows the HSI as you roll out of the turn. If you turn too fast or too slow, you may not be aligned with the runway. Remember that in the mode we are using, the HSI bearing pointer points to the runway. Make small roll inputs to get lined up with the runway final approach course.



Figure 10-8

10. After rolling out on final, you are now between 10–12 nm out. At this point, lower the gear by pressing **[G]**. You must be below 300 knots or you will damage the gear.

In the HUD, the ILS steering cue consists of a horizontal pitch bar and a vertical roll bar in the HUD. When the ILS is called up, these lines will direct you to the ILS glide path. To get on the ILS glide path, you must center these bars.

11. The first bar that should be centered is the vertical bar that displays your course deviation. Make small roll inputs toward the vertical bar to center it in the HUD. Do not chase the vertical steering bar. Lean into it slightly and change your heading approximately 15° . As the vertical bar centers, you can lean back to the runway heading to keep it centered. Remember, the runway heading is 340° . The pitch bar will be above the flight path marker as you approach the runway. Do *not* climb to center the bar. Let it come down to you as you approach the glide path.

In addition to the HUD ILS steering bars, the HSI also displays ILS deviation via the CDI needle and the glide slope indicator on the left side of the round HSI dial.

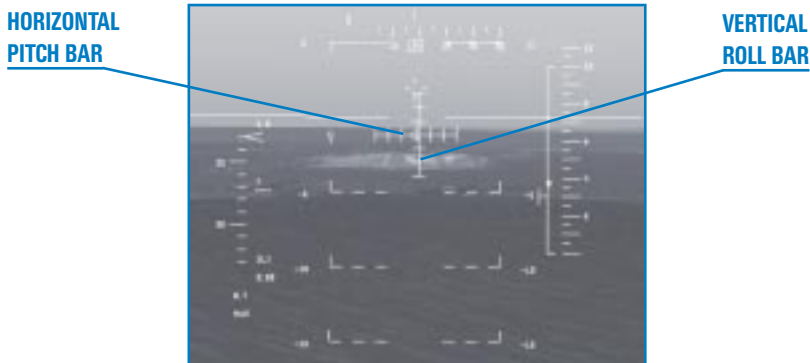

Figure 10-9

12. Now that the gear are down, you will slow rapidly to 160 knots. As you approach 160 knots, set the fuel flow to about 2,000 pounds per hour. This will stabilize the airspeed at approximately 160 knots with the gear down and the speed brakes closed in level flight.



Figure 10-10



Figure 10-11

13. Keep the jet in level flight with the ILS vertical steering bar centered. The ILS glide path indicator will start to descend as you approach the glide path. As the horizontal bar gets to the center of the ADI, deploy the speed brakes by pressing **[B]** and start down the glide path. Figure 10-11 shows this position on the ILS glide slope. You do not need to make a very big power change because 2,000 pounds/hour will hold 160 knots with the gear down and the speed brakes out with the jet descending between 2° – 5° .
14. Once you have the ILS steering bars centered, use the throttle to control your airspeed and keep the AOA scale at 11° . This scale is just to the left of the ADI.
15. When you reach 300 feet, press **[P]** to pause the simulation. Now, press **[1]** on the top row to switch to the HUD Only view. The runway should be in front of you. This is the point where you stop flying with your instruments and start flying a visual approach to the runway.
16. As the jet moves down to 100 feet above the runway, it is time to flare. As you recall from the previous training mission, use a flare to decrease your sink rate in order to place the jet on the runway gently and safely. To flare the F-16, slowly pull back on the stick and shift your aimpoint from the threshold down to the opposite end of the runway. As you shift your aimpoint, bring the power all the way back to idle.
17. Once you touch down and hear the tires screech on the runway, fly the nose gear down onto the runway and press **[K]** to engage the wheel brakes.

Flight Attitude	Gear Position	Speed Brakes Position	Airspeed	Fuel Flow Setting
Level	Up	Closed	200 knots	1,200 pounds/hour
Level	Down	Closed	160 knots	2,300 pounds/hour
2° – 5° down	Down	Fully opened	160 knots	2,000 pounds/hour

MISSION 11: FLAMEOUT LANDING

Picture this... you're flying home from a successful mission. You have long since forgotten about that pesky warning from the jet's voice warning system when suddenly you notice that things are getting very quiet. You are shocked to notice that the motor is not, well, motoring. You are a glider. Your heart sinks into your stomach as you realize that you should have paid attention to that Fuel Low warning. Your only options now are to jump out or crash... right? Wrong. Depending on your altitude, you may be in a position to make a flameout landing on a nearby runway. The F-16 can land without the engine if you are within gliding range of a suitable airfield.

This type of landing in a jet is frequently called a "dead stick" landing, but is not an accurate term for the F-16 because you must have electrical power to land the aircraft. The FLCS (Flight Control Computer System) needs power along with the hydraulic/electric servo actuators that move the flight control surfaces. The hydraulic power that you need to make a flameout landing comes from the EPU (Emergency Power Unit). The EPU is a generator that produces both electrical and hydraulic power when the engine fails. What all this mumbo-jumbo means is that the stick is not really dead.

Since *Falcon 4.0* provides very accurate flight modeling, it is possible to make a flameout landing (just like in the real jet). How well does the F-16 glide? Like a 30,000-pound metal cinder block. Actually, it glides a little better than a cinder block because of the wings... but not a lot better.

The F-16 Dash-1 manual says the F-16 will go 7 nautical miles over the ground for every 5,000 feet of altitude you lose. This makes gliding calculations hard for most fighter pilots like me, so I figure 1-for-1. To see how far you can glide, just take your altitude in thousands of feet and convert it to miles and that is how far you can go. For example, if you are 20,000 feet up, you can glide 20 miles. This number is only good if you fly 6° AOA.



This AOA can be achieved by flying at approximately 210 knots plus 4 knots per 1,000 pounds of gas and external stores with the gear up. (If you lose an engine, you should jettison your external stores immediately.) If you can't make the fuel calculations in your head, just fly 210-220 knots. That will put you close enough to 6° AOA with the gear up. With the gear down, this airspeed changes to 200 knots.

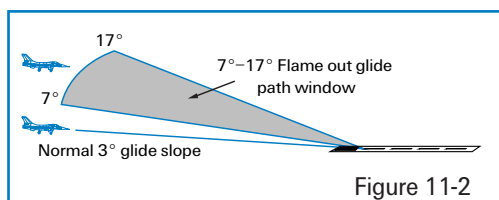

Figure 11-2

Landing is the next step, and it really is just about the same as a normal landing except for the glide path. A normal glide path is 2°-3°, while a flameout glide path is 11°-17° (as seen in Figure 11-2).



Fly the jet on this glide path to maintain the proper airspeed throughout the approach and landing. Because of your steep approach and lack of thrust, you will need the increased airspeed to execute a flare and slow your descent rate. Remember that our normal flare for landing is at approximately 11° AOA, whereas this flare for a flameout landing starts at 6° AOA. Since this is a 50 knot airspeed difference, it takes some practice.

TRAINING MISSION OVERVIEW

You will practice landing with a flamed-out engine.

INITIAL CONDITIONS

- ✦ Airspeed: 250 knots
- ✦ Altitude: 10,000 AGL
- ✦ Throttle Setting: Idle (engine is flamed out)
- ✦ Configuration: Wing tanks, Mk-82 bombs and out of gas
- ✦ Position From the Runway: 10 nm out, 10,000 feet on the runway centerline

MISSION DESCRIPTION

You will start at 10,000 feet with the runway 10 miles on your nose. The jet will be out of gas and the engine will be flamed out. You will hear a “BINGO–BINGO” call from the VMS; press the Master Caution button to clear the voice warning. It will take a few seconds for the Bingo warning to stop.

Perform the following steps to fly a flameout approach:

1. Load training mission “11 Flameout Landing” from Tactical Engagement.
2. Jettison all of your external stores by pressing **Ctrl** **J** or press the Stores Jettison button next to the landing gear lights.
3. Once the stores are gone, check your AOA gauge and fly 6° AOA (approximately 210 knots). Remember, the only way you can speed up or slow down the jet is with pitch. If your AOA is too high (which means you are too slow), push the nose down to speed up. If the AOA is too low (you are too fast), pull the nose up to slow down.



Figure 11-3

- Find the runway out on the horizon. Fly 210 knots toward the runway and note your glide path. In order to keep your airspeed at 210 knots, you need to be in a shallow dive. If this dive is between 11° – 17° , then you have enough energy (altitude and airspeed) to make a flameout landing. If you are less than 11° , you may make the runway. At glide paths of less than 11° , it depends on the winds and just how far below 11° you are.

How do you know what glide path you're on? The best way is to note the position of the flight path marker on the HUD pitch lines. When the flight path marker is on the near end of the runway, you can read your glide path on the pitch lines. For example, if the flight path marker is on the -5° line, you are on a 5° glide path. Figure 11-4 shows the jet on an 11° flameout approach.

FLIGHT PATH MARKER



Figure 11-4



5. Make small bank angle changes to align your flight path straight down the runway.
6. Once you have everything under control, press **[T]** to talk to the tower. Declare an emergency landing by pressing **[3]**. Remember that you should always *fly* the jet first and *talk* on the radio second. The tower does not have a sky hook that they can use to lower you to the ground safely. They're just a bunch of goombahs sitting in air-conditioned comfort drinking coffee. *You* have to fly the jet, so if you don't have time to talk to them—*don't*.
7. Assuming that you are between 11° – 17° , keep the flight path marker on the runway. If the airspeed starts to build above 210–220 knots or your AOA gets below 6° , drop the landing gear by pressing **[G]**. If you are holding the correct AOA, wait and put the landing gear down at 2,000 feet. Remember that if you are going too fast, you can extend the speed brakes by pressing **[B]**. Just don't forget they are out if you get too slow.

8. Keep the flight path marker pointing at the threshold until you get to 500 feet. At 500 feet, make sure that your landing gear is down and locked. Shift your aimpoint down the runway and start a flare. On a flameout landing, you will probably land long. Don't worry about it.

9. Once you touch down and hear the tires screech on the runway, gently pull the gun cross up above the 10° pitch line on the HUD to aero brake the aircraft. In the F-16, the body of the aircraft is used as a giant speed brake to help slow the jet down. The gun cross is used as a pitch reference during the aero brake because the flight path marker gets unreliable once you touch down on the runway. When the jet finally slows below about 100 knots, the nose will fall through to the runway. Again, be sure the throttle is in idle (all the way back).



Figure 11-5

Since your engine will not always flame out

in the exact right spot for a 11° – 17° , 210 knot glide path, here are some suggestions for making the runway:

- ✦ If the runway is rising in your HUD and your airspeed is bleeding off, you will not make it to the runway.
- ✦ It will take you about 7,000 feet of altitude to execute a 360° turn. If you are high and have an extra 7,000 feet, then do a descending 360° turn.
- ✦ If you are high (above the 11° – 17° glide path) but not high enough to do a 360° turn, use the speed brakes and a series of S-turns back and forth to get down to the proper 11° – 17° glide path.

MISSION 12: NAVIGATION AND TIMING

Every fighter pilot needs to know where they are and where they're going on the battlefield. This training mission covers the F-16 avionics that provide you with navigation information.

THE INERTIAL NAVIGATION SYSTEM

The primary F-16 navigation aid is the INS (Inertial Navigation System), which consists of a ring laser gyro that aligns to your initial parking location. When the jet is moved from this location, the stabilized gyro in the INS "precesses" or moves because of the movement of the aircraft. The INS continually uses this gyro precession to compute a new position of the jet based on aircraft movement. Aiding but not replacing the INS is the GPS (Global Positioning System). This system takes satellite information and calculates your aircraft's position. GPS data is not used directly by the F-16, but GPS data is used to update the INS so that if GPS data is lost due to enemy jamming, the F-16 pilot still has the internal (and jam-proof) INS to provide navigation.

In all missions, you have a series of steerpoints, which are simply points on the terrain that are loaded into the INS.



Figure 12-1

These steerpoints are numbered in the order the pilot is expected to fly them. In most cases, the first steerpoint along the route will be Steerpoint 2 and so on all the way to the target and back to the airfield. Your airfield will usually be Steerpoint 1. The Falcon pilot can select a specific steerpoint number and then receive steering in the HUD, HSI or on the one of the MFDs (Multifunction Displays) to that steerpoint.



STEERING CUES

Change the selected steerpoint in the cockpit by using the increment and decrement arrows on the ICP (Integrated Control Panel). Figure 12-2 shows the ICP with these arrows along with the primary HUD steering cues and information. When you change the steerpoint, the number on the DED (Data Entry Display) will change. Bring up the steerpoint display on the DED by pressing the STPT button on the ICP.

INTEGRATED CONTROL PANEL (ICP)

INCREMENT/DECREMENT ARROWS

STPT BUTTON

DATA ENTRY DISPLAY (DED)

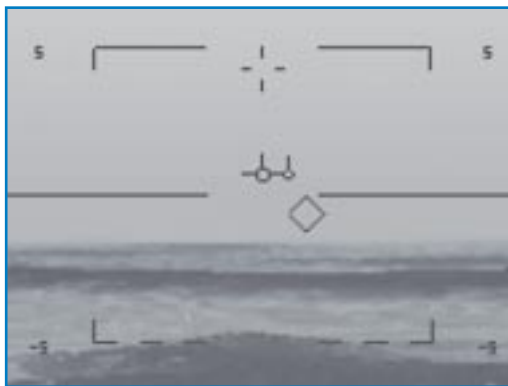

Figure 12-2

Figure 12-2 also shows the steerpoint information that is located in the lower right corner of the HUD. The top line shows ETE (Estimated Time Enroute), which is the time in minutes to the selected steerpoint at your present airspeed. The bottom line shows the distance in nautical miles to the selected steerpoint followed by a ">" sign with the steerpoint next to it. For example, "001>03" means that you are 1 nautical mile from Steerpoint 3. Press **[S]** to increment or **[Shift][S]** to decrement the steerpoint number.

GETTING TO THE SELECTED STEERPOINT

Steering to the selected steerpoint can be accomplished with the HSI, HSD and HUD. When the NAV mode is selected in the DED, a diamond is displayed in the HUD when the selected steerpoint is in the HUD's field of view. This diamond is ground-stabilized over the selected steerpoint and, as you get close to the steerpoint, you should see it lying on the point on the ground that corresponds to the steerpoint coordinates. In this training mission, the diamond will be superimposed over a bridge that is one of this mission's steerpoints. This diamond is present in both the NAV air-to-ground modes. The diamond is not present in the air-to-air modes because a very similar diamond symbol is used in air-to-air to show the position of the AIM-9 missile seeker head.



STEERPOINT DIAMOND

Figure 12-3

Two other steering cues are displayed in the HUD in addition to the diamond. The first cue consists of a vertical line on the HUD heading scale. This fixed vertical line is centered above the HUD heading scale and works in conjunction with another vertical line on the heading scale itself. When the two lines merge to become a single vertical line, you are on a heading that will take you directly to the selected steerpoint.

HUD HEADING SCALE STEERING LINE



Figure 12-4



The last and probably the most important steering cue is the tadpole, which consists of a small circle with a line attached. This cue is present in the HUD and is always positioned level with the flight path marker. When the flight path marker is directly over (or superimposed over) the tadpole, the jet is heading directly for the selected steerpoint. Remember that the flight path marker represents the path through the sky that the jet is flying. The tadpole only provides two-dimensional steering. In other words, it will not command a climb or descent to a planned altitude.

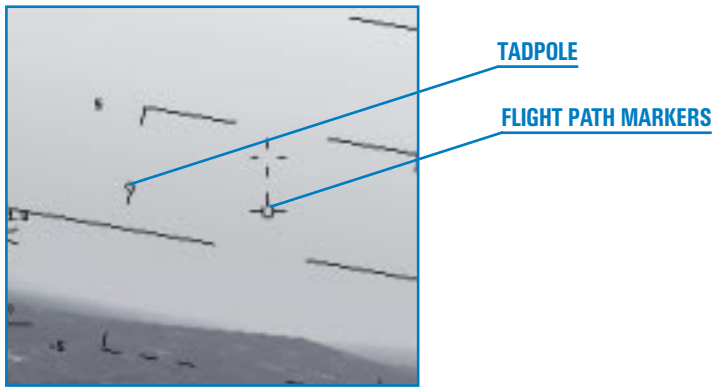

Figure 12-5

THE HSI

The other reference cue for INS navigation is the HSI, discussed in detail in the last training mission. To refresh your memory, the HSI can display either INS or TACAN steering data. When INS data is selected, the bearing pointer on the HSI points to the steerpoint heading on the HSI compass card.

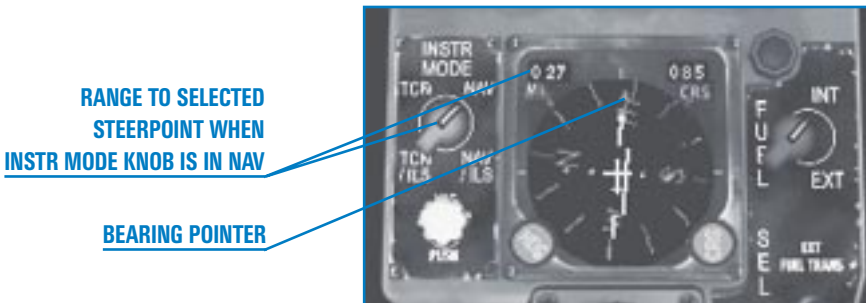

Figure 12-6

THE HSD

INS steering can also be viewed on an MFD with the HSD (Horizontal Situation Display) selected. To select the HSD, press **[2]** for the 2-D Cockpit view to display an MFD. Press **[1]** to cycle the right MFD until you see the HSD.

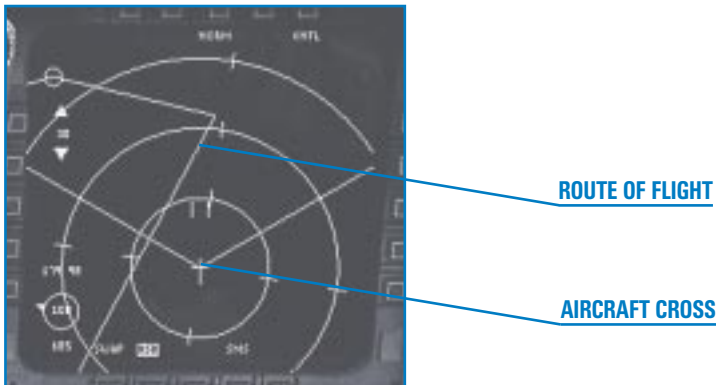

Figure 12-7

The HSD has a fixed aircraft cross in the center of the display (just like the HSI). The route of flight is displayed with lines connecting each steerpoint. The steerpoints are represented by circles, and the HSD steerpoint circle that represents the selected steerpoint flashes. To fly along the depicted route to a selected steerpoint, steer the fixed aircraft symbol over one of the route lines towards the flashing circle. Changing steerpoints will not affect the HSD but will, of course, change your HUD steering. The HSD is an excellent quick reference to show the pilot an overview of the route of flight. It is also very useful in providing INS steering information. Press **[F11]** to decrease the HSD scale or **[F12]** to increase the scale.

The one drawback to using the HSD is that you only have two MFDs, and one of them will usually display radar information. This leaves only one MFD to use for other important displays. Still, the HSD is there if you need it (which I do most of the time).



GETTING TO THE SELECTED STEERPOINT ON TIME

Steering cues are only part of the navigation equation—time is the other. In the *Falcon 4.0* Campaign, it is important to arrive at the target on time. When you plan your mission, each steerpoint has a corresponding desired time or ETA (Estimated Time of Arrival). The F-16 has several displays to help you arrive at the proper place at the desired time. The first of these is the steerpoint display in the DED. Press the STPT button on the ICP to display steerpoint data in the DED.

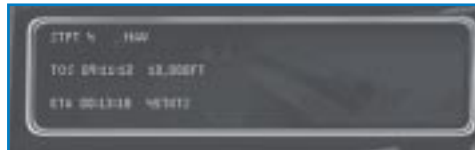

Figure 12-8

The time displayed in the DED is the same time on your watch as if you were living in the *Falcon 4.0* world. We recommend keeping a separate watch set to the time in *Falcon 4.0* while you are flying in the game. Since time will rapidly advance when you select a Campaign mission, you should set your watch to match the time just after takeoff.

The other time that is important is how long it will take you to get to the selected steerpoint. This is called ETE (Estimated Time Enroute), displayed in the bottom right corner of the HUD. So how do fighter pilots get to those steerpoints on time? Well, in the F-16, a cue in the HUD tells you the exact airspeed to fly to get to the selected steerpoint at the planned time. The good news is that you do *not* have to select it—the cue is always there. The bad news is that the cue comes in two formats.

If you have the vertical airspeed and altitude scales called up (by pressing **Ctrl** **H**), then the cue or caret is displayed as a small horizontal line to the left of the airspeed scale as shown below. If you adjust your airspeed to line up with this cue, then you will arrive at the selected steerpoint at exactly the correct time.

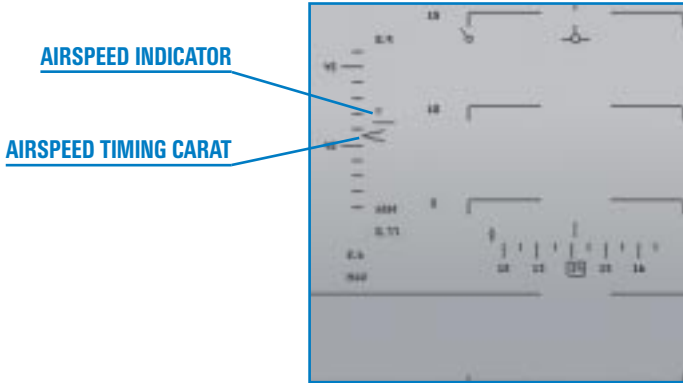

Figure 12-9

If the vertical airspeed and altitude scales are not called up, the HUD displays a digital readout of the airspeed you must fly to get to the selected steerpoint on time.

If you adjust your airspeed to match this displayed speed, you will arrive at the steerpoint on time.

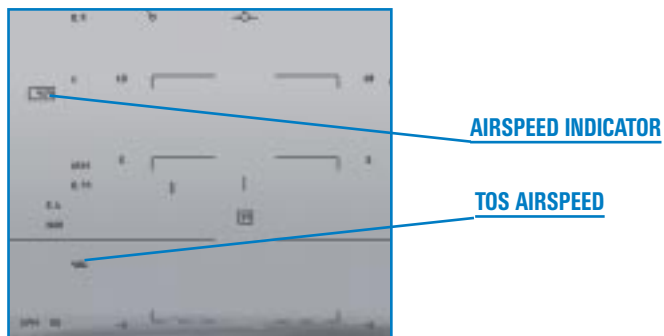

Figure 12-10



TRAINING MISSION OVERVIEW

This mission starts with the jet established on a low-level route. Using the HSD and the HUD, you will practice navigating to each steerpoint on the route and arrive at the target steerpoint at the desired time.

INITIAL CONDITIONS

- ✦ Airspeed: 400 knots
- ✦ Altitude: 5,000 AGL
- ✦ Throttle Setting: Near military power
- ✦ Configuration: Gear up with 6 Mk-82s
- ✦ Weapons Mode: NAV

MISSION DESCRIPTION

In this mission, you are flying a low-level mission to a target. The mission starts with the jet pointed at Steerpoint 4.

The HUD provides a steering cue to the selected steerpoint on the heading scale, with a “tadpole” in the HUD and with a diamond displayed over the selected steerpoint. Center either of these steering cues to fly to the selected steerpoint. In addition to the HUD, remember the HSD (an MFD option) can be used to provide a steering line and an overhead view of the route of flight.

Follow these steps to navigate along the route:

1. Load training mission “12 Nav and Timing” from Tactical Engagement.
2. Press **[S]** until you see “STPT 4” on the DED.
3. Adjust the throttle to fly the airspeed caret on the left side of the HUD. To fly the TOS caret, match the airspeed tick mark with the TOS caret. This caret will get sensitive when you get close to the selected steerpoint, so don’t chase it when you are within 3–5 miles from your steerpoint.

4. Bank the aircraft left or right to center the tadpole under the flight path marker. When you accomplish this, the diamond will be vertically centered in the HUD. You can also use the heading scale in the HUD to line up the vertical steering line. Your HSD provides an overhead view of your route. Press **F11** or **F12** to change the HSD range display. It is helpful to keep the steerpoint you are driving to onscreen.
5. Check your distance remaining to the selected steerpoint in the bottom right corner of the HUD. For example, "15>04" means 15 miles to Steerpoint 4. The first number is the distance in miles and the next number is the selected steerpoint. When you get to the steerpoint (the distance in the HUD goes to zero), the diamond will fall away below the HUD.
6. Select the next steerpoint by pressing **S**.
7. Turn to align the flight path marker over the tadpole again. Once you have done this, adjust your throttle to align the airspeed caret with the TOS caret.
8. Repeat these steps and practice flying the route.

Do *not* let the airspeed and steering cues fly your jet. The tactical situation dictates the speed and position of your aircraft. If you are just driving along, then by all means follow your steering and timing cues. But if the bad guys show up, don't sail along at 300 knots and get your cranium creased because the airspeed caret told you to. The same thing is true of flying the route. If there is a big tank battle going on right in front of you, maneuver to avoid flying over it. You do *not* have to fly the green line between the steerpoints.

If you want to challenge yourself after learning the basic symbology and techniques, make a tight 360° turn at least 25 miles from your next steerpoint and try to arrive on time to your next steerpoint. If you don't make it, try to arrive on time to the next one and so on. You will find that you can lose time easily, and that it is very hard to make up lost time in a fighter.

Another technique you can practice to help recover lost time on a route is to cut out steerpoints. The HSD is a valuable aid when doing this because it provides a god's-eye view of the route. When cutting out steerpoints, however, be careful since you will probably find yourself flying through a worse (or at least different) ground threat picture than you anticipated.

CHAPTER

4



***AIR-TO-AIR
WEAPONS***

These training missions will teach you about the F-16's radar and let you practice delivering specific weapons.

MISSION 13: AIR-TO-AIR RADAR MODES

Falcon 4.0 has several avionics difficulty levels: Easy, Simplified and Realistic. The instructions for these training missions assume that you have chosen the Realistic Avionics setting, which displays the most realistic radar modes.

The F-16 AN/APG-68 can find and track targets that are within $\pm 60^\circ$ of the azimuth and $\pm 60^\circ$ of elevation from the aircraft nose. This does not mean that your radar can instantaneously search this volume of airspace. It means that your radar can point its beam and search a portion of the airspace within this physical limit.



Figure 13-1

The F-16 has several different radar modes, some for use within visual range and others for beyond visual range. Generally, ACM (Air Combat Maneuvering) radar modes are used to lock the radar onto aircraft that are within visual range.

To display the radar on an MFD, press either **[1]** for the left MFD or **[1]** for the right MFD until the menu shown in Figure 13-1 appears. Then cycle through the different air-to-air radar modes by pressing **[F1]**.

OVERVIEW OF AIR-TO-AIR RADAR MODES

To understand Falcon instrumentation, you must understand the concept of master modes and submodes. All the radar modes are controlled using this concept. First, you have to bring up a radar display on one of your MFDs. Switch to the 2-D Cockpit view by pressing **[2]**, as shown in Figure 13-2. The MFDs are the two large square scopes that dominate the cockpit.

The MFD display options are listed around the scope. The option that has been selected is highlighted. In Figure 13-2, the "MENU" option is highlighted. To bring up your radar, select the FCR (Fire Control Radar) option in the top middle. Once you have brought up the FCR on one of your MFDs, you can cycle through the master and submodes of the radar.



Figure 13-2



Most of the time, however, all you have to do to get the FCR to appear is to press **[I]** until “RWS” appears on the left MFD. RWS is the default radar mode. Then you can simply press **[F1]** to bring up the desired air-to-air FCR mode. Once you are in a radar mode, change its operating characteristics by pressing **[F8]** to cycle through the submodes. In the case of the ACM master mode, **[F8]** changes the pattern of the radar significantly. The table below shows how the FCR master modes and submodes cycle.

Master Mode	Submode	Submode	Submode	Submode
[F1]	[F8]	[F8]	[F8]	[F8]
RWS*	±60° sweep	±10° sweep	±30° sweep	
VS*	±60° sweep	±10° sweep	±30° sweep	
TWS**	±25° sweep	±10° sweep		
ACM	HUD Scan	Vertical Scan	Slewable Scan	Boresight Scan

*Always starts in ±60° sweep

**Always starts in ±25° sweep

Press **[F1]** to step through the master modes. Press **[F8]** to step through the submodes for a given master mode.

ACM

The ACM radar mode in the F-16 is used to cue or point weapons. The BVR radar modes can do the same thing, but are also used to help you find the target. This is not true of the ACM mode. In most cases, when you use the ACM mode, you already see the target and are using the radar to point and fire a missile.

The F-16 has four ACM submodes. Press **[F8]** to cycle through these submodes. These submodes are listed below along with the mnemonic (or label) that is displayed in the radar MFD:

ACM Submode	Radar MFD Mnemonic
HUD Scan (30X20)	ACM 20
Vertical Scan (10X60)	ACM 60
Slewable Scan (20X60)	ACM SLEW
Boresight	ACM BORE

Boresight ACM Submode

All of these ACM submodes are directed at the target using the HUD. The Boresight submode points the radar beam straight out the nose of the jet. When you enter Boresight submode, the HUD will display a boresight cross that represents the radar beam. Figure 13-3 shows the Boresight submode with the radar scan pattern and the associated HUD symbology. When you lock onto the target, you will get a TD (Target Designator) box around the target. This box cues you to the target’s position. When the target is outside the HUD with the radar still locked on, the TD box turns into a locator line that originates in the gun cross. This locator line points to the target.

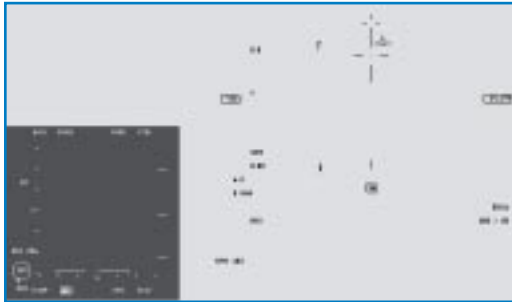

Figure 13-3

Boresight is one of the most commonly used ACM modes because it is very precise. You can lock up the intended target with precision due to the tight scan pattern of the Boresight mode. This mission should start in the RWS mode of the FCR, but if not, press **[F1]** to get to "FCR" on the MFD. Next, press **[F1]** to cycle through the air-to-air radar modes until "ACM" appears. Then press **[F8]** to cycle through the ACM submodes until "BORE" appears next to "ACM."

Vertical Scan ACM Submode

The next ACM submode is the Vertical Scan (10X60). In this submode, the radar is placed into a vertical sweep 10° wide by 60° vertically. The 60° vertical sweep runs from 10° below the gun cross to 50° above. When you enter the Vertical Scan submode, the HUD will display a vertical line, as shown in Figure 13-4.

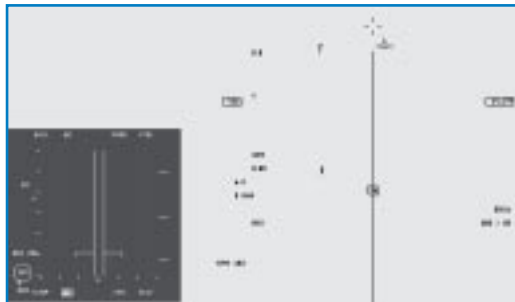

Figure 13-4



The Vertical Scan submode is extremely useful because it can lock up targets that are along your lift vector. The lift vector, shown in Figure 13-5, is a vector line that extends straight out of the cockpit.

Whenever you pull a target toward your nose at high G—and you’ll do this often—you wind up pulling them along your lift vector. As you pull your nose toward a target at high G, you can use the Vertical Scan submode to lock them up before they get into your HUD. Another use for this submode is when you do not have enough energy (you cannot turn at a fast enough rate) to get your nose on the target. Use Vertical Scan in this situation to lock the radar onto the bandit and shoot a missile, even though you may not have the energy to point your nose at the target.

To get to the Vertical Scan submode, press **[I]** until you see “FCR” on the MFD. Next, press **[F1]** to cycle through the air-to-air radar modes until “ACM” appears. Then press **[F8]** to cycle through the ACM submodes until “60” appears next to “ACM” along with a tight vertical scan pattern in the radar display.

HUD Scan ACM Submode

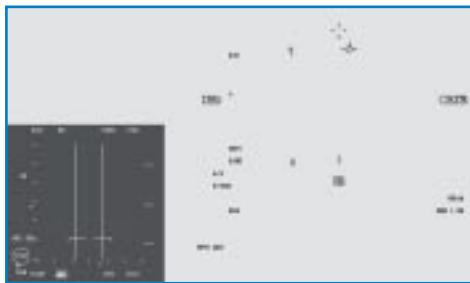

Figure 13-6

The HUD Scan submode is used to lock up any targets that are in a 30X20 field of view. This field of view essentially consists of the Falcon HUD, as shown in Figure 13-6.

This mode is the least useful of all the ACM modes because it is less precise and slower than the Boresight submode. In Boresight, the radar beam sweeps straight out. When it touches a target within 10 nautical miles, it immediately locks on. In the HUD Scan submode, the radar must sweep a pattern to cover the 30X20 area.

This, of course, takes time—and time is not something you can afford to waste in air combat. It is far better to go to Boresight and lock up the target quickly than to stooge around in the HUD Scan submode waiting for the radar to find the target.

To get to the HUD Scan submode, press **[I]** until you see “FCR” on the MFD. Next, press **[F1]** to cycle through the air-to-air radar modes until “ACM” appears. Then press **[F8]** to cycle through the ACM submodes until “20” appears next to “ACM.”

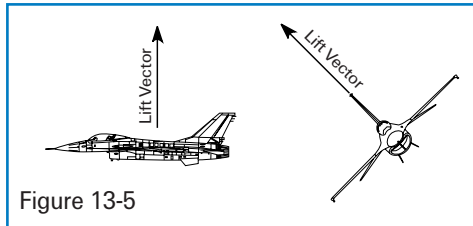

Figure 13-5

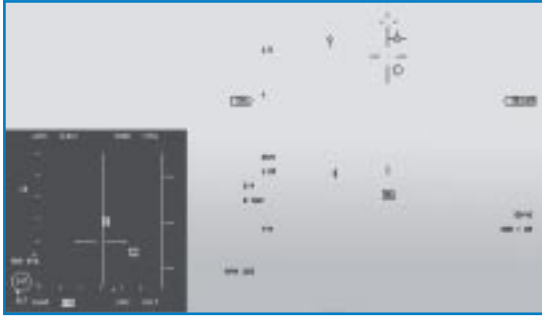

Figure 13-7

Slewable ACM Submode

The Slewable ACM submode provides a slewable or moveable 20X60 scan pattern. When you enter this mode, the HUD shows a vertical cross similar to the Boresight submode cross but with one major difference. In the Slewable ACM submode, a circle will appear somewhere on the cross. This circle represents the center of the 20X60 scan pattern. Figure 13-7 shows the Slewable ACM radar sweep and the associated HUD symbol.

Slewable ACM is a very useful radar mode. It is very different from the other ACM submodes because it is not always used to lock up a target that you see. In fact, this is the only ACM mode that is normally used when you do *not* see a target. The primary use of the Slewable ACM submode is to delouse a piece of airspace that you are going to fly into. For example, let's say you have just bombed a target and are turning to egress the area and head home. As you make your turn to your egress heading, change to the Slewable ACM submode to make sure no bandits are in the area. You can move the scan pattern from level to high above your flight path and then from one side of the HUD to the other. You must do this slowly, though, because it takes the radar time to complete the sweep. Using this technique, you have now swept the area close to you clean of bad guys. You can now change to a longer range (non-ACM) radar mode to look for targets.

Another use for Slewable ACM is when you have a RWR (Radar Warning Receiver) indication that a bad guy is nearby and at a specific azimuth within $\pm 60^\circ$ of your nose. Use Slewable ACM in this case to find the target quickly.

To get to the HUD Scan submode, press **[I]** until you see "FCR" on the MFD. Next, press **[F1]** to cycle through the air-to-air radar modes until "ACM" appears. Then press **[F8]** to cycle through the ACM submodes until "SLEW" appears next to "ACM."

The two primary air-to-air radar modes used for finding BVR (Beyond Visual Range) targets are RWS (Range While Search) and TWS (Track While Scan).

THE B-SCOPE

Both RWS and TWS radar modes are quite complex, but before we go into a detailed description of their radar symbols, you must first understand the concept of a B-scope display. RWS and TWS both present their data in a B-scope format. A B-scope is the best way to present the information from the F-16 radar. So what is a B-scope and how do you read it? It is far easier to answer that question if we first discuss what a B-scope is not. A B-scope does not provide a complete overhead view of the air battle. A B-scope cannot show targets at all altitudes. Finally, a B-scope is limited in both range and azimuth. Figure 13-8 shows a B-scope and how it takes the F-16 radar and presents it on the scope.



Notice in Figure 13-8 how the angular radar beam is pulled apart at the base and spread along the bottom of the scope. When looking at a B-scope, the nose of your jet is not at in the center of the bottom part of the B-scope. The nose of the jet is instead spread along the entire bottom of the B-scope. For example, a target that drifts straight down your scope to the bottom of the B-scope is on a collision course with your jet and will collide with you if you are at the same altitude. Figure 13-9 shows how this geometry works.

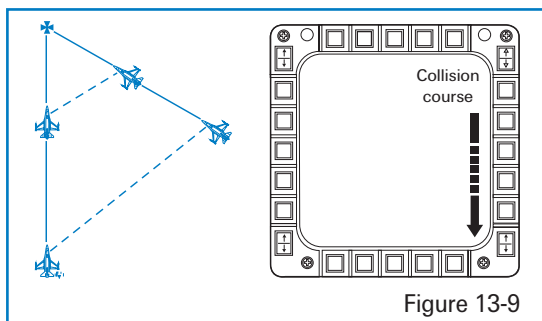
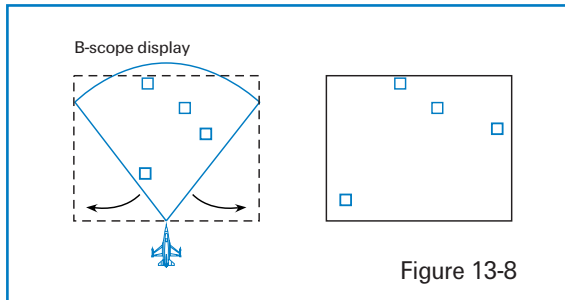

Also notice in Figure 13-9 that the beam is only scanning a very specific volume of airspace. It does not reach all the way to the earth or up into space. The pilot must physically move the antenna's elevation in order to cover specific altitude bands. The B-scope picture represents a limited overhead view of the volume of airspace that your radar sweep pattern is covering. I'm afraid that is all that it represents. For these reasons, the B-scope takes a lot of practice to use effectively.

RWS

Range While Search uses a B-scope display and is the primary F-16 BVR radar mode. RWS is used to find targets and point the AIM-120 AMRAAM and AIM-7 Sparrow missiles. In the RWS mode, you have several search options:

- ✦ Range
- ✦ Azimuth
- ✦ Bar scan
- ✦ Radar elevation tilt

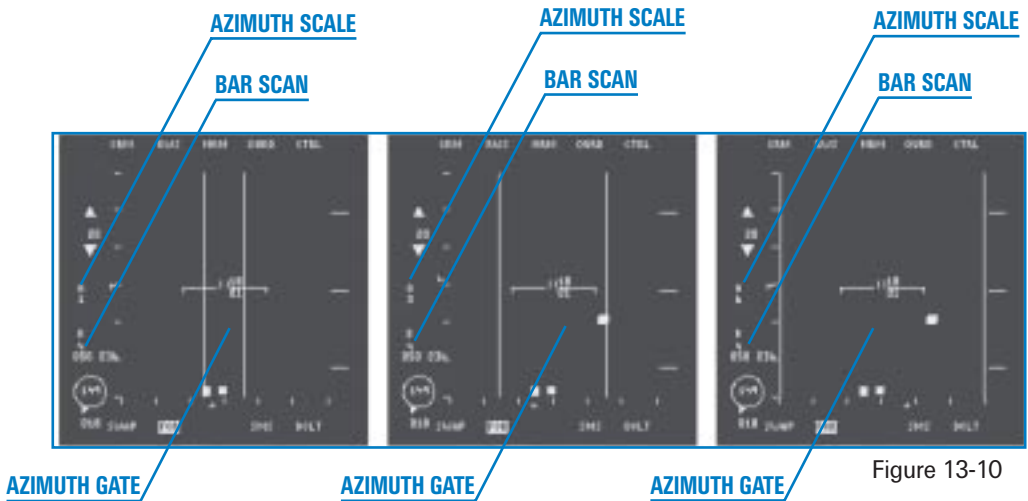

Figure 13-10

In RWS, you can select one of the following range modes: 10, 20, 40, 80 or 160 miles. Most air-to-air targets, however, will not show up on radar until they are well inside of 40 nautical miles. Decrease the radar range by pressing **[F3]** or increase the range by pressing **[F4]**.

The next search option is azimuth sweep. In RWS, you can use $\pm 10^\circ$, $\pm 30^\circ$ or $\pm 60^\circ$ search volumes. Figure 13-10 shows all of these azimuth sweep display options. When you reduce the azimuth sweep, notice how azimuth gates appear on the scope. You will not see targets outside of these gates. Also in Figure 13-10, note the range, azimuth scale and bar scan numbers down the left side of the scope. Change the azimuth sweep of the radar by pressing **[F8]**.

In the F-16, you have three sweep options for the radar beam itself. You can select to sweep it straight back and forth. You can have the radar beam sweep one way and then step up a few degrees and sweep back the other way. Or you can have it step up four times after each sweep. These bar scan options are called 1-bar, 2-bar and 4-bar scans, respectively. The number on the bottom of the left side of the scope shows which option you have selected. Figure 13-11 shows how the beam is moved for each bar scan option.

Remember that it takes time for the radar to complete a full sweep across the scope. If you select 4-bar (which is the most widely used), it will take longer—in fact, twice as long as in 2-bar—for the radar to complete the sweep and start again. That is why you have the different bar scan options. The

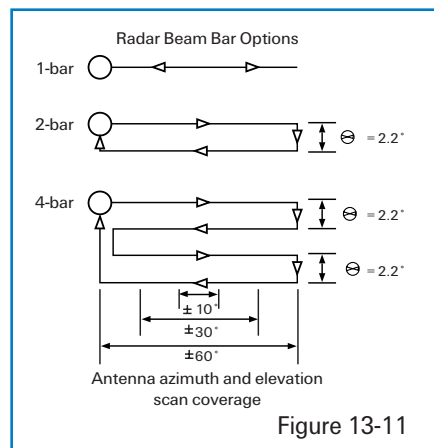
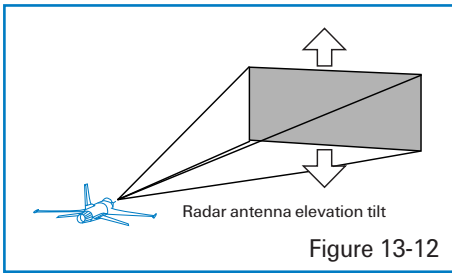

Figure 13-11



drawback is that for a given radar elevation tilt, you are covering less altitude. This can be a major drawback but must be weighed against your need for a fast sweep. As a rule of thumb, if you know where the bandits are, then select 2-bar. Normally, however, it is best to stay in 4-bar scan.

The last option available is the antenna tilt angle. Figure 13-12 shows how you can tilt the entire search volume up and down.

In the F-16, you can tilt the elevation of the entire radar bar scan pattern. Press **[F5]** to tilt the radar down. Press **[F6]** to center the radar at the aircraft altitude. Press **[F7]** to tilt the radar up. You can see the altitude that you are covering with the radar by looking at the radar cursors

The radar cursors are two small vertical lines that can be slewed (moved) in the B-scope display. These cursors are used to lock onto targets displayed. We'll discuss the radar cursors later. For now, let's get back to the radar antenna elevation coverage. Just to the right of the cursors are two small numbers arranged vertically. These numbers show the top and bottom altitude of the bar scan at that cursor range. In other words, these numbers show the minimum and maximum altitude that you are searching with the radar at the radar range of the cursors. Figure 13-13 shows the radar cursors with the altitude numbers just to the right of the cursors.

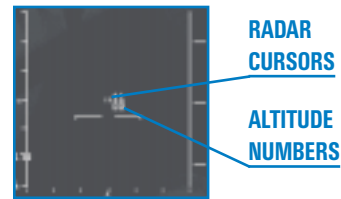
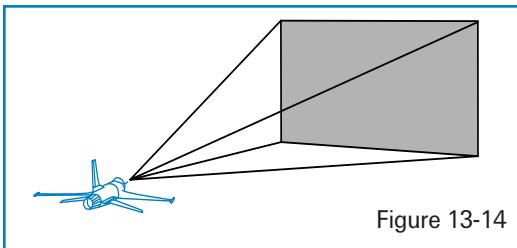

Figure 13-13

Moving the radar cursors does *not* change your elevation tilt or increase the volume of airspace that you are searching. The numbers next to the cursors will change, of course, when you move the cursors up and down the scope. This is because the elevation volume of the radar is angular. For a given bar scan, you are searching a specific volume of airspace that is narrower closer in and wider farther out. This concept is illustrated in Figure 13-14.



When you move the cursors, you can see where the top and bottom of your elevation scan volume is at a specific range.

RWS TARGETS

RWS targets start out life on the scope as small squares. Each time your radar beam passes over the target, another square is generated and displayed. (It's really not that simple, but this is all you need to know for this training mission.) The old square that was generated on the last sweep fades as it stays on the scope for a few radar sweep cycles, creating what F-16 pilots call "target histories." These histories define the path that the target is taking down the scope. When you look at the RWS display, you may see many target squares—but remember, they are not all targets since some are target histories. Figure 13-15 shows the RWS radar cursors, targets on the scope and target histories.

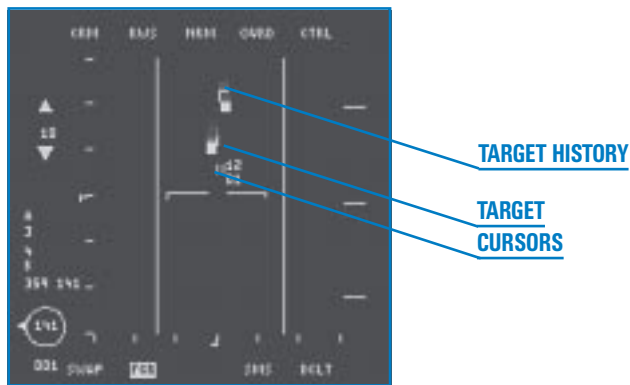

Figure 13-15

Use the radar cursors to lock onto the target. Slew the cursors over the target with \uparrow , \downarrow , \leftarrow and \rightarrow . After getting the cursors over the target square, lock onto the target by pressing \square on the numeric keypad. When you designate a target, the RWS display will change to RWS-SAM (Situation Awareness Mode).

RWS-SAM MODE

RWS-SAM is similar to RWS, but in SAM mode, the radar will track a designated target (called bugging a target) while it still looks for additional targets. Because RWS-SAM has to track a target, however, it can no longer search the same volume of airspace as before. For this reason, the azimuth gates will appear on the scope showing the reduced radar azimuth coverage.



A few other things change besides the azimuth sweep. The biggest difference you will notice is that you now have a target designated. A TD box or locator line appears in the HUD, and the square target symbol changes to an arrow-shaped target with a velocity vector sticking out the nose. Next to this target is a number representing the altitude of the target. The radar cursors are still present, and you can use them to lock onto a different target.

AZIMUTH GATES
DESIGNATED TARGET



Figure 13-16

TWS

TWS (pronounced “twiz”) is a radar mode that tracks multiple targets at the same time. In RWS-SAM, you can track only one target. In TWS (Track While Scan), you can track up to 16 targets simultaneously. That’s the good news. The bad news is that you can’t search the same volume of airspace in TWS. TWS only allows you to select $\pm 10^\circ$ 4-bar scan or $\pm 25^\circ$ 3-bar scan. The other problem with TWS is that the tracking data on each target is not as good as in SAM. You can track a single target in SAM more dependably than you can multiple targets in TWS.

To get to the TWS mode, press **[F1]** until you see “TWS” on the MFD. In TWS, you can get a TD box on a target by designating or “bugging” a target. Even though all targets are being tracked in *Falcon 4.0*’s TWS, you still have to place the radar cursors over a specific target and “bug” that target in order to get your air-to-air missiles pointed at that target. After you bug a target, you will get a TD box or locator line (depending on whether or not the target is in the HUD field of view) on the target.



Figure 13-17

VS

The last and certainly least radar mode is Velocity Search. To get to the VS mode, press **[F1]** until you see “VS” on the MFD. This radar mode changes the MFD from a B-scope to a modified A-scope. An A-scope shows closure (also called overtake). Closure is simply how fast you are closing on a target. In VS you can select either 1,200 or 2,400 knots per hour closure. This means that if you select 1,200 knots on the scale on the left side of the scope, then a target that appears halfway down will be closing on you at 600 knots. The VS scope displays azimuth in the same way as RWS and TWS, but the scope does *not* display range. A Cessna that is 30 miles from you appears at the bottom of the scope while a MiG-25 that is going 600 knots 5 miles away will appear at the top of the scope. It is my theory that this mode was created by a bunch of

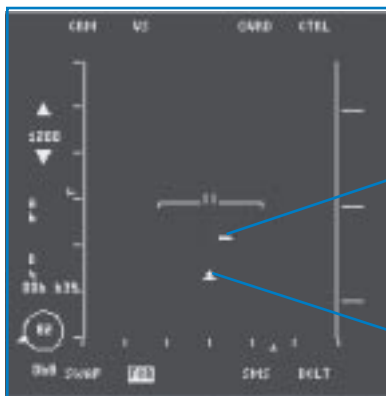

Figure 13-18

Westinghouse engineers as a joke on fighter pilots. If you think about it that way, VS is not too bad. I really have no idea how you would use it in combat. Figure 13-18 shows the VS scope with various targets.

TRAINING MISSION OVERVIEW

This mission starts with the jet in the air facing multiple air targets at various aspects and ranges. You will practice using

the ACM master modes to lock the targets within visual range and the other master modes to lock up the BVR targets.

INITIAL CONDITIONS

- ✦ Airspeed: 400 knots
- ✦ Altitude: 15,000 MSL
- ✦ Throttle Setting: Mid-range
- ✦ Configuration: Gear up, 4 AIM-120s and 2 AIM-9s
- ✦ Weapons Mode: NAV (you must call up the FCR mode desired)

MISSION DESCRIPTION

This training mission presents multiple targets. Press **[Shift][P]** to “freeze” the game. The Freeze mode has been included in *Falcon 4.0* to help you learn radar and other complex F-16 systems. When you first enter the training mission, the jet will be moving. To simply pause the simulation,



press **[P]**. This will stop everything. Unfortunately, radar is nonfunctional in Pause mode. On the other hand, the radar and other avionics still work in Freeze mode. To exit Freeze mode, just press **[Shift P]** again.

The first modes to practice with are the ACM submodes. They are used to lock onto a target that can be seen visually by the pilot. Use the 30X20 HUD submode, the 10X60 Vertical Scan submode and the 20X60 Slewable ACM submode along with the Boresight submode to lock onto visual targets.

The next modes to practice are the longer range RWS and TWS modes (or even VS if you want). Use the radar cursors and the radar elevation tilt to find and lock onto targets.

Here are the steps to accomplish this training mission. Keep in mind that it may be best to accomplish this mission the first time through in Freeze mode (**[Shift P]**).

1. Load training mission "13 A-A Radar Modes" from Tactical Engagement.
2. From the 2-D Cockpit view (**[2]** key), press **[F1]** until you get into the ACM master mode.
3. The first ACM submode is the 30x20 HUD scan mode. When you first enter ACM, "NO RAD" will be displayed on your HUD and radar display. The radar is not radiating to allow you to select the ACM submode you want before locking onto a target. When you select the submode you want, the radar will automatically turn on.
4. Enter the first ACM submode, the 30X20 HUD scan submode. Since multiple targets are out in front of you, the radar should immediately lock onto the first targets it sees without further action from you. You will hear your VMS call "LOCK-LOCK."
5. Cycle through all the ACM submodes by pressing **[F8]**.

The ACM radar submodes are used to lock the radar onto a target that you see. The most useful ACM submode is Boresight. When you see a target, go into the Boresight submode as you are turning to put the target in your HUD. Once the Boresight cross appears in your HUD, place the target under the cross and the radar will lock on. To lock on a target that is straight up your lift vector and out of the HUD, switch to the Vertical Scan submode. The Slewable submode is the one exception to the ACM radar modes. Slewable is primarily used to find a target you do not see. In this training mission, however, you can practice using Slewable by entering the submode and then using **[↑]**, **[↓]**, **[←]** and **[→]** to slew the search volume around. Try locking up the targets in this mission using Slewable and you will see that it usually takes longer to lock them up than it does in the other ACM submodes.

6. After first practicing with the ACM submodes, press **[F1]** to call up the RWS mode. This mode is used to find BVR targets, but it will also display the targets that are close in. Note that in the RWS, TWS and VS modes, you can change the range scale in two different ways. The first is to press the OSB next to the range mnemonic on the left side of the FCR MFD display. The two arrows above and below the selected range scale increase and decrease the range. Another

way to change the range scale, however, is to move the radar cursors to the top or bottom of the scope. This bumps the scale further out or closer in. Figure 13-19 shows the range scale buttons and how the cursors are moved to change the range scale.

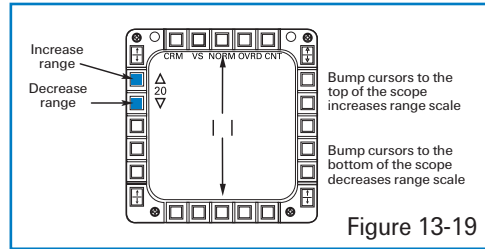

Figure 13-19

7. Change the azimuth sweep by pressing (F8) or by pressing the OSB next to the azimuth readout. As the you change the azimuth sweep, notice that some targets near the edge of the scope disappear since you are no longer seeing them with the radar.
8. Change the bar scan options by pressing the OSB next to "B" on the left side of the MFD. This button cycles the bar scans in RWS and VS between 1-bar, 2-bar and 4-bar. Remember that increasing the bar scan level will increase the elevation scan of the radar (in other words, you are searching more altitude).

9. Practice tilting the radar. These keys do not increase the search altitude; they tilt or move the entire beam up (F5), level (F6) or down (F7). Figure 13-20 shows how the beam is tilted.

Notice that when you tilt the beam, the altitude coverage numbers beside your radar cursors change. As you move the beam and give the radar time to sweep, you can detect targets that were not visible on the radar when the mission started.

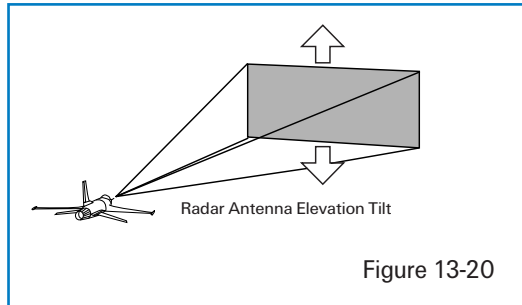

Figure 13-20

10. Lock up targets on the radar by slewing the radar cursors over the target square using (←), (→), (↓) and (↑). When the cursors are over the target, press (0) on the numeric keypad once to bug the target. Press (0) again to lock the target.

This mission was designed for you to go through all the radar options and practice detecting and locking onto targets in all of the FCR master modes.

MISSION 14: 20MM CANNON (AIR-TO-AIR)

This mission will show you how to shoot down enemy aircraft with the F-16's 20mm cannon. This gun was first developed for use on the 1960s-vintage F-104 Starfighter and is still in use today by every U.S. fighter.



GUN SIGHT THEORY

A gun is a simple weapon. You pull the trigger, and the gun shoots straight out in front of you on a predictable path. When you shoot a bullet, it travels in a straight line and is primarily affected by two forces: gravity and drag. In other words, a bullet in flight will get pulled toward the center of the earth by gravity and will start slowing down the millisecond it leaves the gun barrel because it keeps banging into air molecules. The results are easy to calculate and very predictable. The movement of the firing platform (your jet), the rotation of the barrel, and even the alignment of the planets are negligible and irrelevant.

Something must be complicated in all of this, but it is not the gun you're firing. The complicated part of aerial gunnery is this prediction stuff. The future event that is difficult to predict is the target's path through the sky. Intersecting the predictable bullet with an unpredictable (or at least difficult to predict) target is a problem that has befuddled fighter pilots since they first strapped machine guns on biplanes.

Modern fighters such as the F-16 have aiming references called gun sights. These references are displayed in the HUD to help the fighter pilot get bullets on the target. The problem of target prediction doesn't go away when you use a gun sight, but it is minimized. So how do they work? Gun sights provide a reference for shooting bullets to a point in space where the target is going to be (not where the target is now). The gun sight computer knows your cannon and displays an aiming reference in the HUD based on the speed and range of its bullets.

Bullet characteristics are an important factor for gun sight calculations, but the biggest factor by far in providing an aiming cue to the pilot is the range to the target. Just think of shooting clay pigeons with a shotgun. If the target is far away, you have to shoot much further out in front of the target since the shotgun pellets will take longer to get there. Conversely, you don't have to shoot very far ahead of a close-in target. The amount of distance that you have to aim out in front of the target is called "lead for target motion" or just "lead." Leading the target is the most important concept in aerial gunnery.

When you shoot clay pigeons with a shotgun, you look down the barrel of the gun to the aiming sight on the end. You use this sight to tell you where shotgun is aimed. This does not tell you how much lead you need on the target, but it does tell you how where you are aiming. In the F-16, you have a similar reference called the gun cross (as shown in Figure 14-1).

GUN CROSS

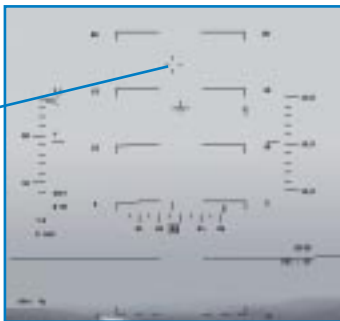

Figure 14-1

The HUD gun cross is like the gun sight on the end of the shotgun barrel. The Falcon gun cross represents the 20mm gun barrel. In other words, the gun cross shows the departure line of the bullets. The bullets will initially travel out the gun cross. Can you ever hit a target with bullets that are fired with the gun cross behind a target? The

answer is no. It is the same thing as trying to hit a clay pigeon moving through the sky with a shotgun that is pointed behind it—impossible. In both of these cases of pointing behind the target, the projectiles will pass well behind the target. Let’s examine a case in which you point the gun cross directly at a target moving across the sky, as in Figure 14-2. Can you hit the target?



Figure 14-2

The answer is again no. The target, of course, will be gone when the bullets get to this location in space. Let’s say you are trying to hit a target at about 2,500 feet. This target is passing at a 90° deflection angle from your jet. Let’s say the bullet will take about 1.5 seconds to reach the target. If the target is traveling at 480 knots (approximately 811 feet/second), the bullets you fire directly at the target will pass 1,216 feet behind the target. This example is simplified a great deal, but it does illustrate why you cannot aim the Falcon gun cross directly at a moving target.

How about shooting a target that is flying straight and level (like a KC-10 tanker)? I know that most of us have had the urge to shoot a tanker sometime. Don’t be ashamed—it’s a universal feeling, kind of like the urge to pop that bubble wrap stuff. Anyway, if you are directly behind a non-maneuvering target, you can point the gun cross straight at the target. All you need to adjust for is gravity.

The gun sights in the F-16 HUD are there to help you aim the gun cross the correct distance out in front of a maneuvering target. Leading the target is not the only thing you need to hit a turning target with the 20mm gun. You must meet two other conditions besides lead: range and plane of motion. Range is simple. You must be in range in order for the bullets to get to the target, somewhere inside of 6,000 feet.

The other parameter you must solve is plane of motion, which means that you must be turning with the target in the same plane. Figure 14-3 shows the target’s plane of motion. If the target changes planes, then you must change planes also in order to hit the target with the cannon.

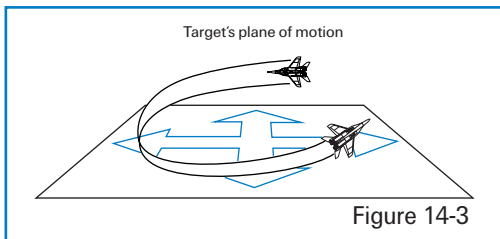

Figure 14-3

In order to understand why this is true, let’s go back to our clay pigeon example. When you are swinging your shotgun out in front of a clay pigeon, you are moving it in the pigeon’s plane of motion. Think of how hard it would be to hit a clay bird with a shotgun if the target were moving across the horizon and you were moving the gun vertically.



Even if you could determine the proper lead angle, it would be very hard to shoot at the right instant to get a hit. The same thing works for aerial gun shoots. You must be moving the gun in the target's plane of motion in order to hit the target. The three things you need, then, for a successful gunshot: the gun must be out in front of the target (lead), the target must be in range, and you must be moving the gun (your jet) in the target's plane of motion.

FALCON GUN SIGHTS

The following three gun sights are available to help you point your gun out in front of the target: the LCOS, the EEGS and the Snapshot line. We will discuss each one, but let's talk about how to call them up in *Falcon 4.0*. Press **[Enter]** until "EEGS" appears in the HUD. Cycle one of the MFDs until you see "SMS." Click that OSB.

LCOS

LCOS stands for Lead Computing Optical Sight and is shown in Figure 14-4.

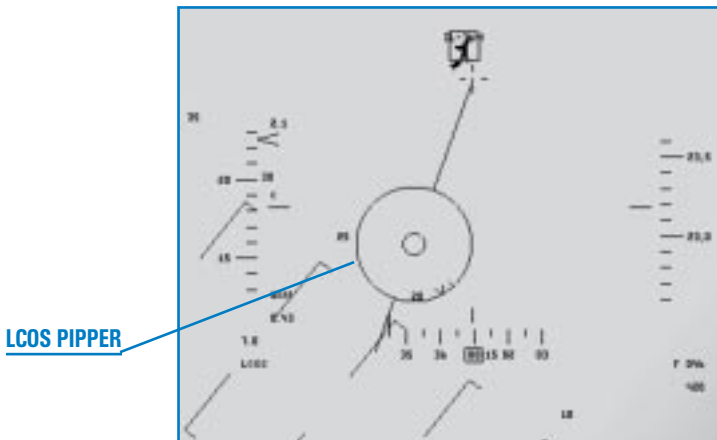

Figure 14-4

The LCOS piper essentially provides a reference target where the gun barrels are currently aimed if the shooter (you) and the target (the other guy) do not change parameters (airspeed, G, range, etc.) for one bullet's time of flight. What it means is that the LCOS piper is accurate if you and the target keep flying the same path at the same speed for the time it

takes for the bullets to leave your gun and arrive at the target. This sounds bad, but it's just the way all gunshots work. Back to our clay pigeon example. Let's say you have the perfect aim out in front of a clay pigeon with a shotgun and just as you shoot, a big gust of wind changes the path of the target. In this example, the shot might miss because the aimpoint you used for the shot is no longer valid. During the time it takes for the pellets to arrive at the target, the target has changed vectors. This is what LCOS is all about. It is only good if everything stays constant through the time-of-flight for the bullets.

This may lead you to believe that the LCOS piper is not a very good aiming reference. This is not true. Most 20mm gunshots have bullet time-of-flights of between 0.5–1.5 seconds. If the enemy pilot does not change G, airspeed or maneuver out of plane in this amount of time, the bullets will shred his cranium. The target has a tough task to avoid being hit by the bullets for several reasons.

The first is that your gun has a very high rate of fire, 100 rounds per second. The second is that the bullet's time of flight is very fast. The third is that the gun has a dispersion pattern of 6 milliradians, which means that 80% of the bullets will hit within a 6-foot circle at 1,000 feet. The F-16 cannon, in other words, has a built-in "shotgun type" dispersion pattern that is designed to hit fighter-sized targets. For all these reasons, you have a good chance of getting a hit when you shoot with the LCOS pippin on the target.

EEGS

EEGS (pronounced "eegz") is a gun sight that combines some elements of the LCOS sight with what is called a predictor sight. A predictor sight is a gun sight that will predict the location of a maneuvering target in space one bullet's time of flight in the future (which is tough unless you have a mind-meld with the enemy pilot). EEGS (Enhanced Envelope Gun Sight) is not a predictor but is very close to being one as well as a great all-around aiming reference. The EEGS gun sight is shown in Figure 14-5.

The primary feature of the EEGS sight is the funnel. The EEGS funnel provides the pilot with a quick reference to help line up in the target's plane of motion. It's also a great reference for getting the gun cross out in front of the target. The correct gunshot solution exists when the wings of the target are just touching the funnel lines. When this occurs, you are aiming the proper distance out in front of the target—it's that simple. In addition, when you hold the target in the funnel, you are also in plane with the target.



Figure 14-5

What makes the funnel so good? The funnel is superior to every other gun sight mentioned when the radar is not locked on to the target. In fact, the funnel gun sight works well with or without a radar lock. This is not true of the only other viable F-16 gun sight mode, LCOS. If you do not have a radar lock with LCOS, the target's G and airspeed are assumed to be the same as yours. While this is bad enough, what's worse is that the target is assumed to be at 1,500 feet when the radar is not locked on. What this means is that the LCOS sight is almost always lying to you when the radar is not locked on (unless the target just happens to be 1,500 feet away).

EEGS, on the other hand, provides a cue in the form of the funnel to get the target to the proper range. Remember that when the wingspan of the target is touching the funnel lines, you are at the correct range for a shot. What about aircraft with different wingspans? Well, the wingspan is set to 35 feet. This wingspan is right in between the wingspan of the F-16 (32 feet) and the F-15 (41 feet). But it really doesn't matter anyway because when using the EEGS funnel, you fire a burst and move the target through the funnel. This technique accounts for differences in target wingspans (more on technique later).



In addition to the funnel, the EEGS sight also has a set of MRGS lines (Multiple Reference Gun Sight) lines at the bottom of the EEGS display. The MRGS lines help you line up in the target's plane of motion. Another EEGS feature are the small "+" and "-" signs that appear when you are locked onto the target. These symbols are essentially a 1 G (+) and 9 G (-) pipper. If the target is at 9 Gs, the 9 G pipper provides an accurate reference for a gunshot. Most of the time, however, the target will be somewhere between 1 and 9 Gs so the aiming solution will be somewhere in between these pippers.

SNAPSHOT LINE

The Snapshot line is an aiming reference that is not very useful against maneuvering targets. The Snapshot line is shown in Figure 14-6.



Figure 14-6

The Snapshot line essentially shows an artificial tracer line of bullets (without your actually having to fire). This tracer line has time-of-flight tick marks at 0.5, 1.0 and 1.5 seconds respectively. In addition to these tick marks, a pipper appears on the Snapshot line when the radar is locked to the target. If the radar locks onto a target at 1,500 feet and calculates that the bullet will take 0.8 seconds to travel that 1,500 feet, a pipper will appear on the Snapshot line at that range (in between the 0.5 and 1.0 second tick marks). The Snapshot line, therefore, essentially shows the history of where the gun cross (your gun barrels) have been. The operative word here is "history." It does not give you a prediction of where to shoot out in front of the target. The only thing it provides is a history of where you have been pointing the gun.

TRAINING MISSION OVERVIEW

In this training mission, you will practice using the EEGS and LCOS symbology to shoot down enemy aircraft. The mission will present several target problems simultaneously. The object is to eventually practice gunshots on all of these targets, but start by pursuing only one target. After finishing off the first target, reset the mission and select another target problem.

INITIAL CONDITIONS

- ✦ Airspeed: 400 knots
- ✦ Altitude: 10,000 MSL
- ✦ Throttle Setting: Mid-range
- ✦ Configuration: Gear up and clean
- ✦ Weapons Mode: NAV

MISSION DESCRIPTION

This mission starts with three different aircraft in front of your jet. These different targets allow you to practice various gunshot setups. When the mission starts, a Tu-16 Badger bomber will be almost directly on your nose. This target will start a gentle turn. The next target is a MiG-29 Fulcrum that will start line abreast with the Badger, but the Fulcrum will start a more aggressive turn when the mission starts. Both of these targets are at low aspect (that is, you are looking at their tails). The last target is an IL-76 that is low at 9,000 feet and coming straight at you. In this mission, since you will start at a similar speed with the target aircraft, overtake will not be a problem if you watch your power setting. The IL-76 Beagle, however, is a head-on target for you to practice difficult head-on shots.

Here's how it's done for the low aspect and beam aspect targets (the Tu-16 and the MiG-29):

1. Load training mission "14 20mm Cannon (A-A)" from Tactical Engagement.
2. Call up Dogfight mode by pressing **[D]**. EEGS and ACM radar will appear.



Figure 14-7

3. Do *not* look at your EEGS or LCOS symbology yet. Since all gunshots start at the gun cross, the first step is always to place the gun cross in front of the target. An easy way to do this is to picture a line extending straight out of the nose of the target. The gun cross should be placed along that imaginary line.

Noting your range and overtake, use the throttle to stabilize behind the target. Figure 14-7 shows where the range and overtake are displayed in the HUD.

4. Use your EEGS or LCOS symbology to get a precise gun solution. In EEGS, start with the target at the bottom of the funnel (pulling a big lead angle) and let the target fly up the funnel by easing off the G. Shoot a 2-second burst as you ease off on the G and let the target fly up the funnel by pressing **[1]** or joystick button 1. Figure 14-8 shows this technique.



Figure 14-8



With LCOS, you should get a radar lock on the target. The procedure is the same, however, with or without a radar lock. Fly the target under the LCOS pipper by placing the gun cross out in front of the target's nose. When the LCOS is over the target, shoot, adjust and then shoot. This means that you should fire a 1-second burst and then watch where the tracers go. Make an adjustment and then fire another short burst.

5. When the target maneuvers, always readjust your aim by moving the gun cross as discussed in Step #3.

Here is how to take a high line of sight rate shot (the IL-76):

1. Again, look at where the target is going and place the gun cross on an extended imaginary line that sticks straight out the nose of the target.
2. Don't even try to use EEGS or LCOS to line up the shot. When taking head-on shots, the gun cross is your only good aiming reference. Place the gun cross out in front of the target and begin firing early. When the gun cross gets to the nose of the target, cease firing.

Be very careful. If you are taking a head-on gunshot on a fighter target, he may be shooting back at you. If not, there is the danger of midair collisions. Figure 14-9 shows a head-on shot against the IL-76 target.

Use these procedures to practice gunning all the targets. Try using both EEGS and LCOS with and without radar lock-on. If you get bored and need to waste some time, you can also try using the Snapshoot line.



Figure 14-9

MISSION 15: AIM-9 SIDEWINDER

In this training mission, you will learn how to shoot the AIM-9 Sidewinder missile. The AIM-9 is a heat-seeking missile that has steadily evolved since it was first developed in the 1950s. Two different models of the AIM-9 are featured in *Falcon 4.0*: the older rear-aspect AIM-9P and the newer all-aspect AIM-9M. The difference in these missiles can be seen in their envelopes or WEZ (Weapon Engagement Zone) shown in Figure 15-1. The WEZ describes the area around the target in range and aspect that the missile can be successfully fired.

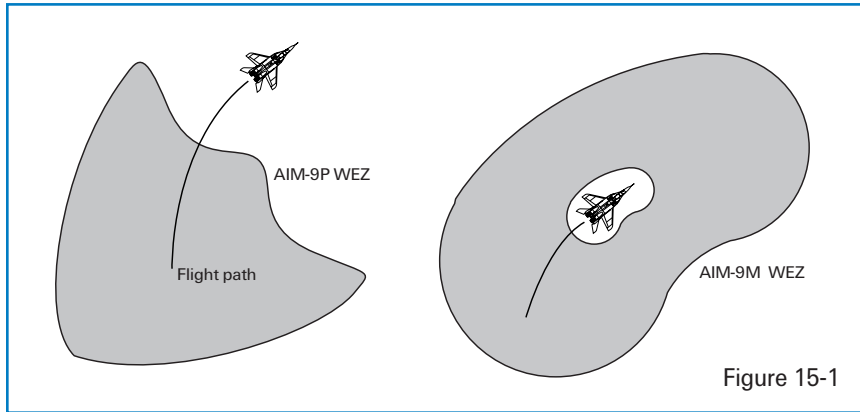

AIM-9s are very simple to understand and employ. Aircraft engines produce heat, and the AIM-9 seeker head tracks heat. The AIM-9P can only see the engine heat when looking up the target's tailpipe. The AIM-9M, however, can see the heat from the target's engine from all aspects or, in other words, from 360° around the target.

AIM-9 MECHANIZATION

The current model AIM-9 seeker heads can track targets before the missile is even released. The actual position of the seeker head is fed into the HUD so the pilot can see if the missile is tracking the intended target. This upgrade first arrived in the late 1970s and changed the way the missile was employed. Before this time, the seeker head of the older model AIM-9s (such as the "E" model used in Vietnam) was "caged" or fixed. The pilot pointed the missile at the target, got a heat tone and let it fly. The seeker head would "uncage" or gimbal to look for the target only after it left the rail. The pilot never really knew if the missile was going to track the target until it was fired.

Both the AIM-9P and the AIM-9M have seeker heads that uncage while the missile is still on the jet. The pilot can see the target in the HUD and then check that the missile is tracking the target. The position of the AIM-9 seeker head is displayed in the HUD as a diamond. This "missile diamond" is the primary AIM-9 cue to ensure that missile is on the target.

The other critical AIM-9 display in the HUD is the DLZ (Dynamic Launch Zone) bracket. This bracket tells you if you are in range for an AIM-9 shot. It is important to realize that this DLZ is only present with a radar lock on the target. Figure 15-2 shows Falcon AIM-9 HUD symbology.

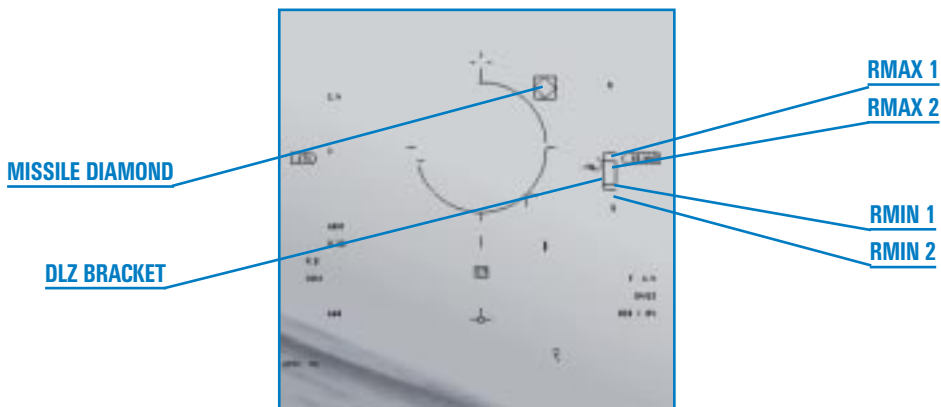

Figure 15-2

The DLZ bracket has several parts that are labeled in Figure 15-2:

- ✦ Rmax1 is the maximum range that you can shoot the missile at the target.
- ✦ Rmin1 is the minimum range that you can shoot the missile at the target.
- ✦ Rmax2 represents the top of the maneuver zone of the DLZ. Rmax2 is a more realistic maximum range for a target that is maneuvering.
- ✦ Rmin2 represents the bottom of the maneuver zone of the DLZ. Rmin2 is a better cue for minimum range for a target that is maneuvering.

The DLZ bracket only provides kinematic information on a potential missile shot. Kinematics refers to the ability of the missile to come off the rail and make it to the target—not *guide* on the target—just *get to* the target. Any shot between Rmax1 and Rmin1 can theoretically make it to the target. Shots between Rmax2 and Rmin2, however, have a higher probability of making it to a target that is maneuvering to avoid the missile. Remember that the AIM-9 is a heat-seeking missile and besides kinematics, or the ability to reach the target, the missile must also be able to track the *heat tone* generated by the target.

The heat tone is an audio signal. The heat tone is simply a tone fed into to the pilot's headset that provides feedback on the quality of the missile track. If the tone is faint, the missile is barely tracking the target (even though you can see the missile diamond in the HUD over the target). If the tone is loud, then the missile has a solid track. There is no other good rule of thumb for the heat tone except the level or intensity of the tone. You just have to get a feel for the AIM-9 heat tone.

This brings up a very important point about the AIM-9. You do need a radar lock on the target to provide DLZ information in the HUD, but you do *not* need a radar lock to shoot an AIM-9. The AIM-9 is a launch-and-leave heat-seeking missile. All you need to shoot an AIM-9 is to be in range and have a heat tone from the target. You can use your own eyes to estimate the range to the target for an AIM-9 shot where you can see the seeker head position in the HUD via the missile diamond. If the missile diamond is on target and you estimate that you are in range, shoot the missile. The exception to this procedure is the case of the rear-aspect AIM-9P. With the AIM-9P, you must also be behind the target (as illustrated in Figure 15-1).

While no-lock shots are possible and necessary at times, it does help to have a radar lock for two reasons. The first is that a radar lock will provide you with the DLZ bracket, which is better than your eyeballs for estimating range. Second, the radar can be used to point the AIM-9 seeker head at the target so you won't have to point the jet at the target to get the AIM-9 missile looking in the right direction.

In *Falcon 4.0* the AIM-9 is *almost* always slaved to the radar. If the radar is not available, then the missile will find the first target it sees in the HUD and lock on. By using slave with a radar lock-on, the pilot has both a missile diamond cue over the target and a DLZ bracket (provided by the radar) to ensure that he is in range of the target. Remember that the missile diamond tells you where the missile seeker head is pointing.

HOW TO CALL UP YOUR AIR-TO-AIR MISSILES

There are two basic ways to view your AIM-9 missile symbology: the Dogfight mode and the stand-alone AIM-9 mode. To call up the AIM-9 modes in the stand-alone mode, press **Enter** until the AIM-9 appears. In the Dogfight mode, the AIM-9 is called up along with the EEGS gun sight for an air-to-air engagement. In Dogfight mode, as shown in Figure 15-3, you can use both the gun and the AIM-9 missile.

Call up the Dogfight mode by pressing **D**, which is like flipping the Dogfight switch on the F-16 throttle.

Only missile symbology is displayed in the other AIM-9 missile mode. In this stand-alone mode, you get a much cleaner AIM-9 display but you lose the EEGS gun sight. Figure 15-4 shows the AIM-9 missile mode.

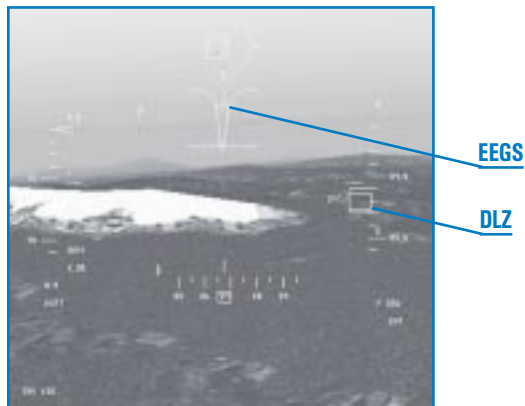

Figure 15-3

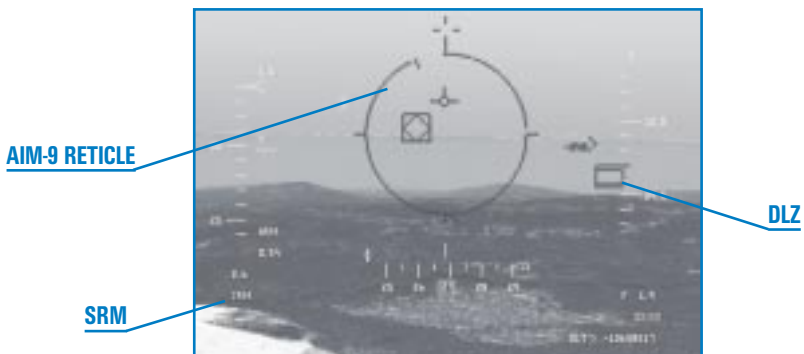

Figure 15-4

Call up the AIM-9 missile symbology by pressing **[Enter]** to cycle through your air-to-air weapons until an AIM-9 reticle appears. You can tell when you have AIM-9s because “SRM” (Short-Range Missile) will appear in the lower left corner of the HUD. In addition, the AIM-9 has a missile tone. As you continue to press **[Enter]**, you will cycle through all of the air-to-air missiles that you have loaded on your jet. When AIM-7s or AIM-120s appear, the label “MRM” (Medium-Range Missile) appears in the lower left corner of the HUD.

One last very important point. You can have both AIM-9Ps and AIM-9Ms loaded. Cycle between these two missile types by pressing **[I]** until “AAM” appears at the top of the left MFD. Now click on OSB-6 to step through all of the air-to-air missiles loaded on your jet. Note that as you press this OSB, the display will step through the missiles on all of the rails on the aircraft. For example, if you have two AIM-9Ps, two AIM-9Ms and two AIM-120s loaded, the first time you press OSB-6, the display will step to the next AIM-9P loaded. The next time you press the OSB, it will step to an AIM-9M, then the next AIM-9M and finally the AIM-120s.

TRAINING MISSION OVERVIEW

In this training mission, you will practice using AIM-9M and AIM-9P Sidewinders to shoot down enemy aircraft.

INITIAL CONDITIONS

- ✦ Airspeed: 400 knots
- ✦ Altitude: 5,500 MSL
- ✦ Throttle Setting: Mid-range
- ✦ Configuration: Gear up with 3 AIM-9Ps and 3 AIM-9Ms loaded
- ✦ Weapons Mode: NAV

Training Mission Aids

Two aids are available to assist you in this training mission. The first is the Labels function. To see the targets more easily, turn on labels by pressing **[Shift][L]**. The labels are displayed over the vehicles and other objects.

The other aid is the Freeze mode. Enter Freeze mode by pressing **[Shift][P]** to pause the simulation but still use the radar and all other avionics. If you are in Freeze mode, you can lock your Sidewinder onto the target but your plane will not move through the sky. You must press **[Shift][P]** again to see the missile guide toward the target.

MISSION DESCRIPTION

This mission starts with three different aircraft in front of your jet. The targets are the same ones used in Training Mission 12, but in this mission, they are further away. The first target to pursue is the Tu-16 Badger bomber, which is in a gentle right-hand turn. The next is a MiG-29 Fulcrum which starts line abreast with the Badger but will start a more aggressive left-hand turn. Both of these targets are at low aspect (you are looking at their tails). The last target is the IL-76, which is slightly low and 4 nm away, coming straight at you.

In this mission, you can lock on the radar, which will point the AIM-9M seeker head at the target. The all-aspect AIM-9M can be used to shoot at all three targets. The AIM-9P, in contrast, is limited to rear aspect and can only be used when you are within 40° of the target's tail. The Badger and the Fulcrum are good targets to practice AIM-9P shots since they are presenting their rear aspects at the start of the fight.

The AIM-9 missile is very easy to use. Follow these steps:

1. Load training mission "15 AIM-9 Sidewinder" from Tactical Engagement.
2. Switch to Dogfight mode by pressing **[D]**.
3. Lock onto one of the targets using an ACM radar submenu.
4. Freeze the simulation by pressing **[Shift][P]**.
5. If you do not have the AIM-9P called up, press **[I]** until "AAM" appears at the top of the left MFD. Next, press OSB-6 until "AIM-9P" appears. The AIM-9P seeker head should slave to the target. Check to see that the missile diamond in the HUD is over the desired target.
6. Listen for a distinct missile growl or tone.
7. Check your DLZ bracket in the HUD. The caret (which looks like a sideways "V") should be between Rmax1 and Rmin1.
8. Unfreeze the simulation by pressing **[Shift][P]**. If you are not in range, push the power up and get closer to the target.



9. If you are in range and have a good heat tone, shoot—look—and shoot again if the missile fails to guide. Shoot the missile by pressing [Spacebar] or joystick button 2.

Practice taking shots with both AIM-9Ps and AIM-9Ms. Remember that the AIM-9P is a rear-aspect missile that can only lock onto the stern of the target, while the AIM-9M is an all-aspect missile that can lock onto the target from any angle.

MISSION 16: AIM-120 AMRAAM

In this training mission, we will discuss how to shoot the AIM-120 AMRAAM (Advanced Medium-Range Air-to-Air Missile). This radar-guided missile is the most lethal air-to-air weapon in the U.S. inventory. Developed in the 1980s by the U.S. Air Force, the AIM-120 is now carried on Navy and Marine Corps jets as well as fighters from many allied nations. The key feature of the AMRAAM (nicknamed the “Slammer”) is its launch-and-leave capability. The AIM-7 Sparrow missile (which the AIM-120 replaced) requires the shooter to stay locked on the target all the way to missile impact. With the AIM-120, however, you can launch the missile and break radar lock on the target at a specific point during the missile’s TOF (Time of Flight). This allows you to leave the fight or look for another target without hurting the missile’s Pk (Probability of Kill). This capability gives you a significant advantage over fighters carrying the older AIM-7 type missiles.

The AMRAAM has a radar in the nose of the missile which can lock onto a target. Since this radar is much smaller than the radar in the F-16, it cannot track a target as far away as the F-16’s radar. The F-16 therefore must first find the target and guide the AIM-120 to a point close enough for the AIM-120’s smaller radar to acquire it. When it reaches this point, the missile becomes autonomous and guides without further help from the F-16. The basic AMRAAM HUD display is shown in Figure 16-1.

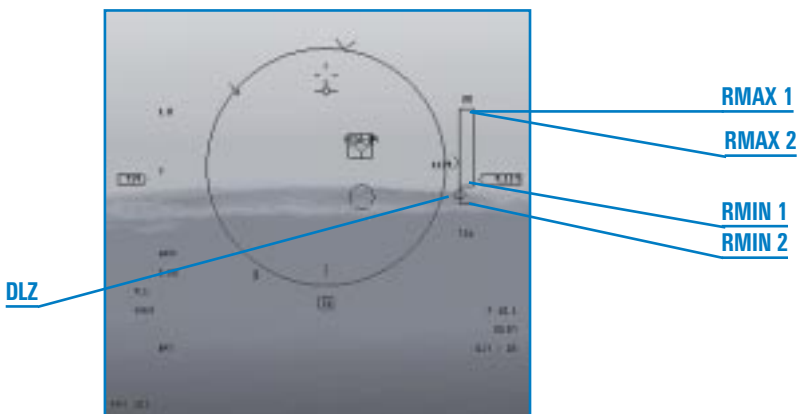

Figure 16-1

Notice that the AIM-120 display looks very similar to the AIM-9 display. Both missiles have a missile reticle and a DLZ bracket on the right-hand side of the HUD with basically the same information. The DLZ information displayed is identical for both missiles.

- ✦ Rmax1 is the maximum range that you can shoot the missile at the target.
- ✦ Rmin1 is the minimum range that you can shoot the missile at the target.
- ✦ Rmax2 represents the top of the maneuver zone of the DLZ. Rmax2 is a more realistic maximum range for a target that is maneuvering.
- ✦ Rmin2 represents the bottom of the maneuver zone of the DLZ. Rmin2 is a better cue for minimum range for a target that is maneuvering.

AIM-120 AMRAAM MECHANIZATION

We have discussed how the missile goes autonomous at some point in its TOF. Your HUD symbology will cue you when this key event in the life of the AIM-120 occurs. When you fire an AIM-120 at a target, a time countdown appears directly under the DLZ bracket. The countdown time is displayed on the HUD in two different ways depending on whether the missile is autonomous or not. Figure 16-2 shows where this time is read.

If an "A" is displayed in front of this countdown, the time is counting down the seconds it will take for the missile to go autonomous. After the "A time" counts down to zero, the missile can guide on the target without help from the F-16. When the "A-time" gets to zero, a new countdown in seconds starts with a "T" replacing the "A." The appearance of the letter "T" means that the missile is active and pursuing the target. The time that is now being displayed next to the "T" is the time in seconds to missile impact or time to the "Target." Any time you see a "T" in the HUD, you can break lock on the target. To review, the "A" countdown means time before the missile goes autonomous whereas the "T" countdown means time until the missile impacts the target.

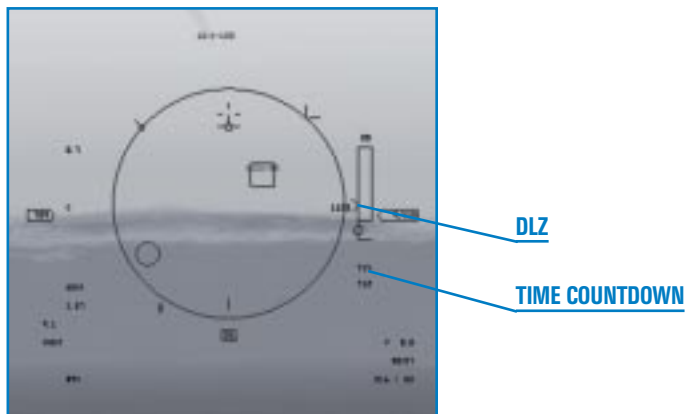

Figure 16-2



Note that when you shoot a missile, another set of AMRAAM timing numbers will appear in the HUD. When there is no missile in the air, you only have one number—but as soon as you shoot, you have two sets. The bottom readout shows information on the missile in flight, while the top readout shows information on the next missile to fire. If you shoot a second missile and have two missiles in air, the information on the first missile will be dropped and now your two sets of readouts will show the last missile fired and the next missile to fire. Your HUD will never show information about two AIM-120s in flight.

HOW TO CALL UP YOUR AIM-120S

The AIM-120 is called up the same way as the AIM-9, with only one minor exception—there is no combined AIM-120 and EEGS gun sight mode like Dogfight. To get to your AIM-120s, hit **[Enter]** until the AIM-120 reticle appears in the HUD. You can tell when you have AIM-120s because “MRM” (for “Medium-Range Missile”) will appear in the lower left corner of the HUD. Notice that the reticle for the AIM-120 is much larger than the reticle for the AIM-9. In addition, you will not hear the Sidewinder tone. Next, press **[J]** until “AAM” appears at the top of the MFD. AIM-120 should be displayed on the right side of the display. If the display shows any other missile (AIM-7 or AIM-9), press the OSB until “A 120” appears.

You can also call up AIM-120s by pressing **[M]** for the MRM mode. This mode is similar to the Missile Override position with the Dogfight switch in the real F-16. So far it sounds like the AIM-120 is in its own private AIM-120 world. The truth is that the MRM mode can also be used for the AIM-7 Sparrow. The AIM-120 is the primary medium-range missile for Falcon, but the AIM-7 can also be loaded. If both missiles are present, the AIM-120 will come up first and has higher priority. If only AIM-7s are present, then the AIM-7 will be called up when you press **[M]**.

TRAINING MISSION OVERVIEW

In this training mission, you will practice using the AIM-120 to shoot down enemy aircraft.

INITIAL CONDITIONS

- ✦ Airspeed: 400 knots
- ✦ Altitude: 10,000 MSL
- ✦ Throttle Setting: Mid-range
- ✦ Configuration: Gear up with 4 AIM-120s
- ✦ Weapons Mode: NAV

MISSION DESCRIPTION

This mission starts with a group of MiG-25s coming straight at you. Use the Freeze mode (**[Shift][P]**) to take your time analyzing your AIM-120 symbology. Remember, you must exit Freeze mode to actually see a missile fly toward the target.

Practice taking AIM-120 shots on all the targets that appear and watch your missiles time out in the HUD. Here is how to take an AMRAAM shot:

1. Load training mission "16 AIM-120 AMRAAM" from Tactical Engagement.
2. Select the AMRAAM mode by pressing **[M]**.
3. Fly in a straight line until you see targets appear on your radar. When they appear, turn to place the targets in the HUD missile reticle.
4. Freeze the simulation by pressing **[Shift][P]**.
5. Press **[F4]** until your radar is in the 20-mile range. The targets should appear on the radar. Place the radar cursors over one of the targets using **[↑]**, **[↓]**, **[←]** and **[→]**. When the radar cursors are over the target, press **[0]** on the numeric keypad to designate the target.
6. When you are locked onto the target, check the caret in the DLZ to ensure that you are in range for a shot. The caret (the sideways "V") should be between Rmax1 and Rmin1.
7. Unfreeze the simulation by pressing **[Shift][P]**.
8. Shoot the AIM-120 missile (**[Spacebar]** or joystick button 2) and watch the time-to-active ("A") or time-to-impact ("T") count down in the HUD. You can break lock on the target when you see the "A" turn into a "T" in the HUD.

If you do not see a flash in the TD box as the time to impact goes to 0 ("T 0"), then shoot again.

On this mission, it is important to lock onto all the targets in each target group to see the effect of aspect on the DLZ. Remember that the target controls the aspect. All the enemy aircraft has to do to affect your DLZ is turn his jet.

MISSION 17: AIM-7 SPARROW

In this training mission, you will learn how to shoot the AIM-7 Sparrow. This radar-guided missile was first introduced in the 1960s as an integral part of the F-4 Phantom weapons system. Since then the Sparrow has been repeatedly modified and improved to fire from the F-14, F-15, F/A-18 and F-16 fighter jets. The current model of the AIM-7 in use on the Falcon is the AIM-7M. Block 50/52 F-16s are not armed with AIM-7s, but they are included in *Falcon 4.0* to provide you with all the weapons that can be carried by the F-16.



What are the differences between the AIM-7 and the AMRAAM? The AIM-7 Sparrow missile requires the shooter to stay locked onto the target all the way to missile impact. On the other hand, a pilot firing an AIM-120 can launch the missile and break radar lock on the target at a specific point during the missile's TOF. The requirement to stay locked to the target for the missile's entire time of flight is the biggest limitation of the AIM-7. The missile guides on reflected radar energy that is provided by the F-16 radar. Think of the F-16 radar as a giant spotlight that illuminates the target. The AIM-7 Sparrow then homes in on this spotlight. If the spotlight is ever turned off (that is, if the F-16 radar breaks lock on the target), the missile will lose the target and miss.

As shown in Figure 17-1, the basic HUD display of the AIM-7 is virtually identical as the AIM-120 AMRAAM display.

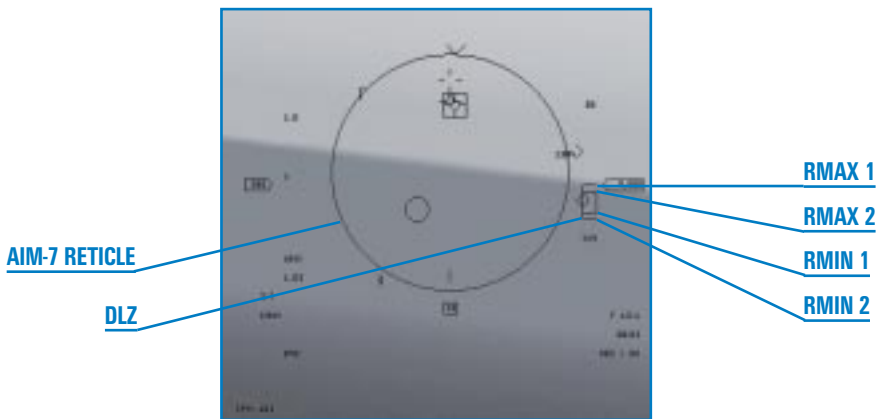

Figure 17-1

Notice that the AIM-7 display looks very similar to the AIM-9 display and identical to the AMRAAM display. All Falcon air-to-air missiles have a missile reticle and a DLZ bracket on the right-hand side of the HUD with basically the same information. The DLZ information displayed is identical for both missiles.

- ✦ Rmax1 is the maximum range that you can shoot the missile at the target.
- ✦ Rmin1 is the minimum range that you can shoot the missile at the target.
- ✦ Rmax2 represents the top of the maneuver zone of the DLZ. Rmax2 is a more realistic maximum range for a target that is maneuvering.
- ✦ Rmin2 represents the bottom of the maneuver zone of the DLZ. Rmin2 is a better cue for minimum range for a target that is maneuvering.

AIM-7 SPARROW MECHANIZATION

Remember that the AIM-7 guides on reflected radar energy from the F-16 radar. When the missile is fired, you have a time countdown in the lower right corner of the HUD under the DLZ. You must keep a radar lock on the target until the time in the lower corner of the counts down to zero.

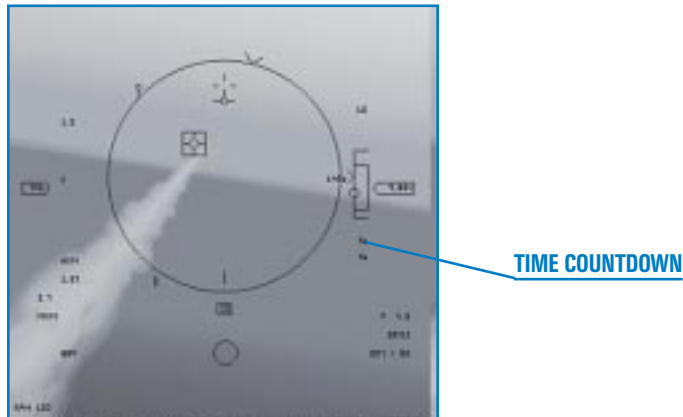

Figure 17-2

Notice how the time readout looks the same as the AMRAAM timeout when the missile goes autonomous.

HOW TO CALL UP YOUR AIM-7S

The AIM-7 is called up the same way as the AIM-120. To get to your AIM-7, press **Enter** until the AIM-7 reticle appears in the HUD. You can tell when you have AIM-7s because "MRM" will appear in the lower left corner of the HUD. Notice that the reticle for the AIM-7 and the AIM-120 are identical. If you have both AIM-120s and AIM-7s loaded, the only way to determine which missile you have is to look at your SMS page.

You can also call up AIM-7s by pressing **M** for the MRM mode. This mode is similar to the Missile Override position with the Dogfight switch in the real F-16. Remember that MRM is a mode that is used for both AIM-120s and AIM-7s. If you only have one type loaded (as on this training mission), no problem. If you have both AIM-120s and AIM-7s, however, the AIM-120 will come up first because it has a higher priority. If you have both missiles loaded and you want to switch from AIM-120s to AIM-7s, press **J** until "AAM" appears at the top of the right MFD. Next, press the OSB next to the AIM-120 mnemonic on the right side of the MFD until "A7" appears.



TRAINING MISSION OVERVIEW

In this training mission, you will practice using the AIM-7 to shoot down enemy aircraft.

INITIAL CONDITIONS

- ✦ Airspeed: 400 knots
- ✦ Altitude: 10,000 MSL
- ✦ Throttle Setting: Mid-range
- ✦ Configuration: Gear up, 2 AIM-7s and no guns
- ✦ Weapons Mode: NAV

MISSION DESCRIPTION

This mission starts with several MiGs out in front of your jet. Use the Freeze mode to take your time analyzing your AIM-7 DLZs. Practice taking AIM-7 shots on all of the targets and watch your missiles time out in the HUD. Here is how to take an AIM-7 Sparrow shot:

1. Load training mission “17 AIM-7 Sparrow” from Tactical Engagement.
2. Select the AIM-7 by pressing **[M]**.
3. When the MiG-25 targets appear, turn to bring them into the missile reticle.
4. Freeze the simulation by pressing **[Shift][P]**.
5. Place the radar cursors over the target you want to shoot with **[↑]**, **[↓]**, **[←]** and **[→]**. When the radar cursors are over the target, press **[0]** on the numeric keypad to designate the target.
6. When you are locked onto the target, check the caret in the DLZ to ensure that you are in range for a shot. The caret (the sideways “V”) should be between Rmax1 and Rmin1.
7. Unfreeze the simulation by pressing **[Shift][P]**. If you are out of range, drive in closer.
8. When you are in range, shoot the AIM-7 missile by pressing **[Spacebar]** or joystick button 2. Watch the time to impact (“T”) count down in the HUD. Remember that with the AIM-7, you *cannot* break lock on the target.

If you do not see a flash in the TD box as the time to impact goes to zero ("T 0"), then shoot again.

On this mission, it is important to lock onto all the targets in each target group to see the effect of aspect on the DLZ. Remember that the target controls aspect. All the enemy aircraft has to do to affect your DLZ is turn his jet.

CHAPTER

5



***AIR-TO-GROUND
WEAPONS***

These training missions will teach you about the F-16's air-to-ground radar and let you practice delivering specific weapons.

MISSION 18: AIR-TO-GROUND RADAR MODES

In this training mission, you will learn how to use air-to-ground radar. The air-to-ground and the air-to-air radar have the same purpose: to find targets and point weapons. The air-to-ground radar is optimized to search for both stationary and moving targets on the ground.

GROUND MAP RADAR MECHANIZATION

The air-to-ground radar maps the terrain with a radar beam and presents a return or picture in the

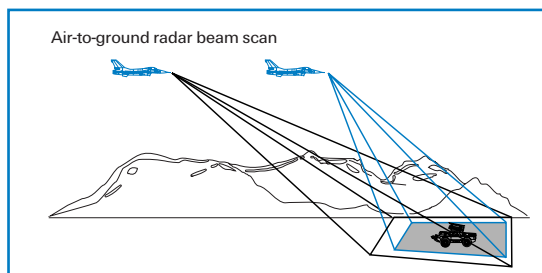

MFD. The radar beam is swept along the ground in a pattern, $\pm 60^\circ$ in azimuth. In the primary air-to-ground radar modes, the radar beam is *centered* on the selected steerpoint. Figure 18-1 illustrates this very important concept.

In the air-to-air radar modes, the radar searches straight out in front of the jet and moves down track with the jet. This is not how most F-16 air-to-ground radar modes work. In the primary air-to-ground radar, as

Figure 18-1

the selected steerpoint gets closer, the radar antenna keeps tilting to center the beam on that point on the ground. This is done automatically, without it being locked on the target, and without pilot input. If the steerpoint is not on the radar scope because it is more than 60° off the nose or outside the selected range scale, no radar picture is displayed.

Think of the F-16's air-to-ground radar as a way of searching for targets around a steerpoint or a way of looking at the steerpoint itself. This does not mean that the radar cannot find targets that are well away from the steerpoint—it can. It's just that the radar is optimized for searching for targets close to the steerpoint because that is where the radar beam is centered in range. The probability of finding targets, therefore, is much higher if they are close to the steerpoint.

THE AIR-TO-GROUND RADAR DISPLAY

Falcon 4.0 has three master air-to-ground radar modes and numerous submodes. The three master modes are GM (Ground Map), GMT (Ground Moving Target) and SEA. To get to the air-to-ground displays, press [1] until RWS appears in the left MFD. Then press [F2] to cycle through the air-to-ground radar modes. All of these modes have identical radar displays even though they are used to find different types of targets. GM, the primary mode, is used to find stationary targets. GMT is used to find moving targets, such as trucks and tanks. In GMT, stationary targets such as bridges and building are not displayed. The SEA mode is exactly like GM except the radar is optimized to find ships. Figure 18-2 shows an air-to-ground radar display.



Note that the air-to-ground radar display has an artificial horizon line that is identical to the horizon line in the air-to-air modes. Keep in mind that this line does not represent the wings of your jet but rather the earth's horizon. In other words, this horizon line moves opposite the wings of the aircraft when you roll.

The air-to-ground radar display also shows range in the same way as the air-to-air radar. Range to the target is determined by distance from the bottom of the scope and the range scale selected. A target that is halfway

up the scope is 20 miles from your jet if the radar is set to the 40-mile range. Select the range scale by pressing the OSB (Option Select Button) next to one of the range scale arrows on the side of the MFD. The azimuth scale, just below the range scale, is permanently set to "A6" or azimuth $\pm 60^\circ$. This means that the radar is sweeping $\pm 60^\circ$ of your heading, a total of 120° .

RANGE SCALE



Figure 18-2

AIR-TO-GROUND RADAR CURSORS

The radar cursors are used to point and track targets on the radar scope. The air-to-ground cursors consist of a long horizontal and vertical line that intersect to form the tracking point of the air-to-ground radar. The tracking point is centered over the selected steerpoint in the primary air-to-ground radar modes. Move this tracking point off the steerpoint by pressing \uparrow , \downarrow , \leftarrow and \rightarrow . Moving the radar cursors moves the center of the radar beam. Just moving the cursors, though, does not actually track or lock onto a target.

To lock onto a target, move the radar cursors over the target with \uparrow , \downarrow , \leftarrow and \rightarrow and then designate the target (0 on the numeric keypad). After you designate the target, a diamond will

then appear over the target and the cursors will track that target. Figure 18-3 shows the "post-designate" or locked-on display of the air-to-ground radar display.

When the diamond appears on the scope, the radar beam is tracking the target and is now centered in range and azimuth over the target.

LOCKED TARGET

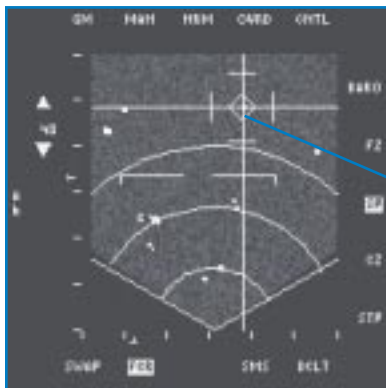

Figure 18-3

Remember that the air-to-ground radar is used to track targets and point weapons. When you move the cursors and lock onto a target, you get attack steering in the HUD to that target. This attack steering is provided via the CCRP (Continuously Computed Release Point) bombing mode. CCRP is explained in full in the next training mission, but you need to know that CCRP mode is important because it ties the air-to-ground radar display to the HUD. CCRP is an attack mode that provides steering in the HUD to the position of the air-to-ground radar cursors. In other words, when you move the cursors, the CCRP steering in the HUD will also move, as shown in Figure 18-4.

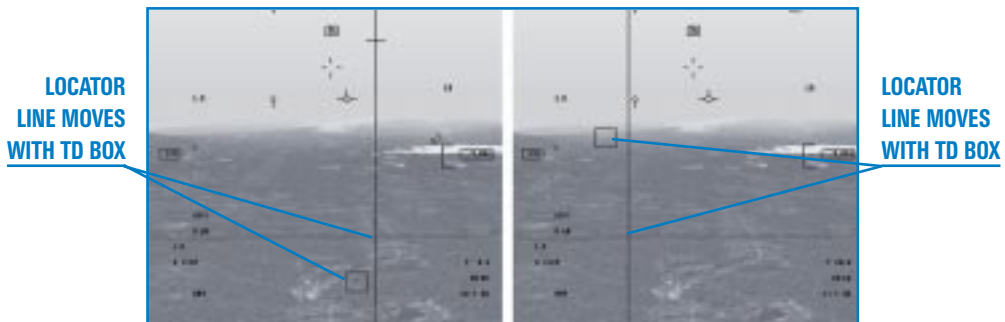

Figure 18-4

To call up CCRP, press `[Backspace]` until “CCIP” appears at the top of the right MFD. Next, press `[]` until “CCRP” appears at the top of the right MFD. You do not need to have CCRP called up to use the air-to-ground radar. You do need CCRP, though, if you want HUD steering to the position of the radar cursors. CCRP mode is very useful if you have slewed (moved) the radar cursors away from the steerpoint. Remember that the radar cursors are initially over the selected steerpoint when you enter the air-to-ground radar modes. When you slew the cursors or lock onto a target that is not co-located with the steerpoint, CCRP is the only way to get steering to that target or cursor position. HUD steering cues are still present in the HUD when you are not in CCRP, but these cues will take you to the steerpoint and not to the position of the cursors.

Other weapons and systems can also be slaved or pointed via the air-to-ground radar cursors:

- ✦ AGM-65 Maverick missile
- ✦ Targeting pod for LGBs (Laser-Guided Bombs)

How does this work? Let’s say you find a target with your air-to-ground radar and lock onto it. If you have a Maverick missile called up, it can be slaved to the air-to-ground radar cursors, which will point the missile’s seeker head at the target. Specific training missions later will discuss the use of the air-to-ground radar with all of the systems.



Radar Scope Mnemonics and Functions

Several mnemonics are arranged horizontally around the scope.

GM, GMT and **SEA** stand for Ground Map, Ground Moving Target and Sea. These are the air-to-ground master modes. One of these labels will be displayed in the top left corner of the MFD. Cycle through these modes by pressing the OSB on the MFD above “GM” or by pressing **[F2]**.

MAN stands for “Manual” and is a fixed display in *Falcon 4.0*.

NRM stands for “Normal” and is one of the four GM submodes. All the other submodes of the air-to-ground display provide the pilot with some form of radar zoom capability. The **NORM** submode displays four lines that form a box around the outside of the center point. This is the area that will be expanded (or zoomed in) when the next submode, **EXP** (Expand). is selected. There some important differences between the **EXP** and its close cousins, **DBS1** and **DBS2**, and the **NORM** submode.

When you select **EXP**, the radar picture is zoomed in around the cursors so you can see more detail. When this happens, the radar cursors are centered in the display so you can no longer tell the azimuth or range of the target by looking at the scope. All you see in the **EXP** mode is the area right around the cursors and you no longer see the pie-shaped **NORM** display. Figure 18-5 shows the **NORM** and **EXP** mode of the exact same target.

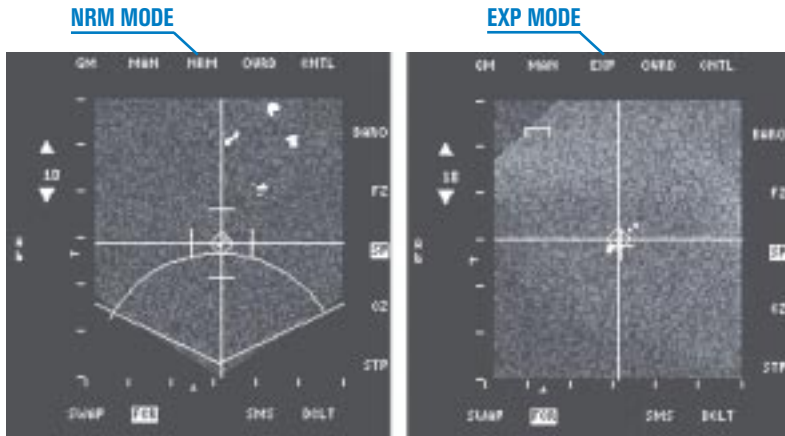

Figure 18-5

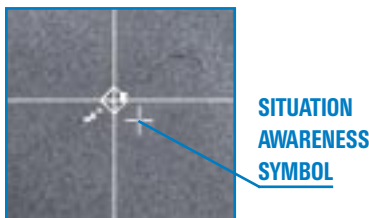

Figure 18-6

Notice in **EXP** that you have gained another symbol, the situation awareness symbol. This symbol moves on the scope to provide the relative position of the **EXP** display to the nose of the aircraft. Figure 18-6 shows how this works.

By the way, if you do turn the jet so that the radar can no longer see the EXP point on the ground, the radar automatically reverts back to the NORM mode.

The other submodes that are closely related to EXP are DBS1 and DBS2. DBS stands for Doppler Beam Sharpening. DBS1 provides a slightly better Expand picture with the same basic characteristics. In DBS2 the radar picture is zoomed in even closer than in EXP or DBS1.

EXP expands the radar display around the cursors and centers it on the scope.

DBS1 refines the EXP mode and provides more detail but no more magnification.

DBS2 zooms in on the EXP mode, providing the highest level of magnification around the radar cursors.

All of these air-to-ground radar submode displays are centered on the scope. Do not forget that NORM and EXP are the only available submodes in GMT and SEA. DBS1 and DBS2 are not available in GMT or SEA; they are only mechanized in the GM mode.

OVRD stands for "Override." Press this OSB to turn the radar off and on. If you shut down the radar, you are less likely to be detected by the enemy.

BARO stands for "Barometric" ranging and is a preset option in *Falcon 4.0*.

FZ stands for "Freeze." Press the OSB to toggle the radar into freeze mode, which freezes the radar display but allows you to still have information on the scope even though the radar is temporarily shut down. This mode is used to cut your radar emissions (and thus your signature on the battlefield) and still give you use of the air-to-ground radar modes.

SP stands for "Snowplow." Snowplow is a very important mode because it *disconnects* the radar beam from the steerpoint. When you select Snowplow, the air-to-ground radar beam sweeps out in front of the jet like the air-to-air radar beam. In other words, it is no longer tied to the selected steerpoint.

CZ stands for "Cursor Zero." Press this OSB to zero out or erase any cursor slews that the pilot has put into the system. Let's say you see a radar target just to the right of your steerpoint and slew the air-to-ground cursors over this target. If you change your mind and want to move the cursors back over the steerpoint, just press the OSB for CZ. The radar cursors will return to the steerpoint. CZ is very useful when you start flailing around with the cursors and you need to get them back to where you started.

STP stands for "Steerpoint." This tells you that the cursors are set to track the steerpoint. In the air-to-ground radar modes, either "SP" or "STP" will be highlighted to indicate that the radar is tied to the steerpoint or is fixed out in front of your jet.



RADAR TARGETS

Radar targets are displayed as bright spots on the scope. The GM mode can only see man-made objects such as buildings and bridges. In the GMT mode, the radar can only see moving targets such as tanks and trucks. In the SEA mode, the radar will only display ships. Once displayed on the radar scope, however, all of these targets can be tracked and you can point air-to-ground weapons at them.

TRAINING MISSION OVERVIEW

This mission starts with the jet in the air facing both stationary and moving ground targets.

INITIAL CONDITIONS

- ✦ Airspeed: 400 knots
- ✦ Altitude: 7,000 AGL
- ✦ Throttle Setting: Mid-range
- ✦ Configuration: Gear up with 2 CBU-87s, 2 Mk-84s and 2 AIM-120s
- ✦ Avionics: NAV

MISSION DESCRIPTION

In this training mission, targets will appear on the air-to-ground radar display in several different modes. This purpose of this mission is to gain a working knowledge of the air-to-ground radar.

When you first enter this mission, the radar cursors will be close to Steerpoint 4, which is a bridge.

1. Load training mission "18 A-G Radar Modes" from Tactical Engagement.
2. Once the training mission starts, freeze the jet in the sky by pressing **[Shift][P]**. In Freeze mode, you can practice using the radar without having to fly the jet.
3. Call up the CCRP mode by pressing **[Backspace]** to bring "CCIP" up at the top of the MFD.
4. Click on the OSB next to "CCIP" and "CCRP" will appear.
5. GM radar should automatically appear in the left MFD when "CCRP" comes up in the right MFD. It is useful to be in the CCRP bombing mode when using the air-to-ground radar so that you can see how the air-to-ground radar cursors are tied to the your CCRP HUD steering.

If GM radar does not come up in the left MFD, select GM master mode by pressing **[F2]** until the "GM" mnemonic appears in the upper left corner of the radar display. Press **[F2]** to cycle through all of the air-to-ground radar modes.

- As shown in Figure 18-7, Steerpoint 4 is displayed on the DED and a diamond overlays Steerpoint 4 on your HUD.



Figure 18-7

- Once you are in GM mode, slew the TD (Target Designator) box in your HUD over the steerpoint diamond. Look at the GM radar. Note that the cursors are now centered over Steerpoint 4. The target bridge will appear as a bright green dot on the radar scope.

- While you are slewing the radar cursors, glance at the HUD and notice that your TD box is moving to the left and right of the diamond. This example shows how the TD box in air-to-ground radar is tied to the radar cursors. Slew the cursors well off the diamond. Press the OSB labeled "CZ" (Cursor Zero) on the right side of the MFD and notice how the cursors jump back to the center of the radar display. Remember that when you hit CZ, you zero out any slews that you have made. When you zero out slews in Snowplow mode, the cursors go back to the center of the display.



Figure 18-8

- Slew the TD box back over the diamond and lock onto the bridge by pressing **[0]** on the numeric keypad. Notice how a diamond appears on the radar display.
- Try slewing the cursors and notice that they will not move. When you are locked onto a target, the cursors track only the target and cannot be slewed. Break lock on the target by pressing **[.]** on the numeric keypad to return the radar to the search mode. When you break lock, the diamond will disappear from the radar display and the cursors will slew again.

Remember that at any time you can change the radar range scale by pressing **[F3]** and **[F4]**. As a rule of thumb, it is best to reduce your range scale when your target of interest is in the bottom half of the display.



The GMT mode is next.

1. Select GMT master mode by pressing **[F2]** until “GMT” appears in the upper left corner of the radar display. It will take a few sweeps for the radar to adjust, but after a few seconds, the radar display will show only moving ground targets. In this mission, several tanks are near the bridge. These targets were not visible on the radar in the GM mode, but when you change to GMT, the tanks appear on the scope (as shown in Figure 18-9).

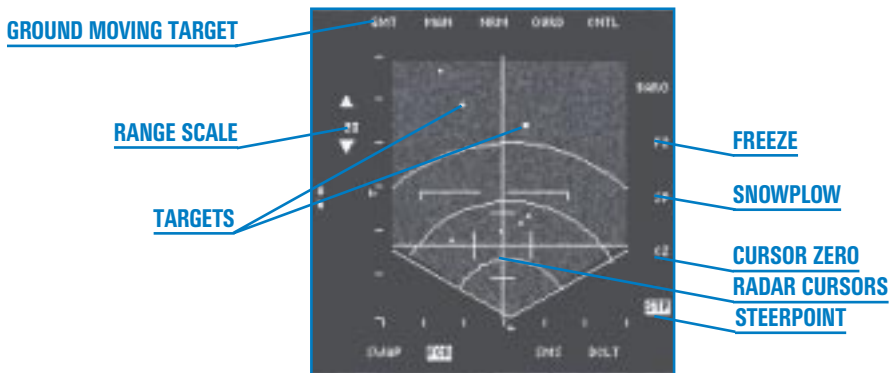

Figure 18-9

2. Lock onto one of these targets by slewing the radar cursors over the target with **[↑]**, **[↓]**, **[←]** and **[→]** and pressing **[0]** on the numeric keypad. A diamond will now appear over the target on the radar display just as in GM mode. The TD box and cursors will now track the moving target.
3. Break lock on the target by pressing **[.]** on the numeric keypad. Return to the GM mode by pressing **[F2]** until “GM” appears in the radar display.

These next steps will take you into EXP, DBS1 and the DBS2 submodes.

1. Go to the 40-mile scope either by pressing the OSB next to the range scale on the MFD or by slewing the cursors to the top of the scope. You can also change the range scale by pressing **[F3]** or **[F4]**. Recall that in the air-to-air radar you can change the range scale just by moving the cursors to the top or bottom of the scope. The same technique works for the air-to-ground radar display.
2. Click on the OSB labeled “STP” on the left MFD. Select Steerpoint 5 by pressing **[5]** to step through the steerpoints. Steerpoint 5 is near a group of buildings. The radar cursors will jump to this new location on the radar display.

- Slew the cursors around the buildings and then go to the EXP submode by pressing the OSB on the MFD above the "NRM" mnemonic. This button will cycle you through the EXP, DBS 1 and DBS2 submodes. DBS 1 and DBS2 require some time to build a radar picture to display. Go through all these submodes and notice how the display changes for each one. Keep in mind that in all of these submodes the radar cursors will be centered on the radar display. Return to EXP submode. Figure 18-10 shows the series of radar pictures of this target using NORM, EXP, DBS1 and DBS2.

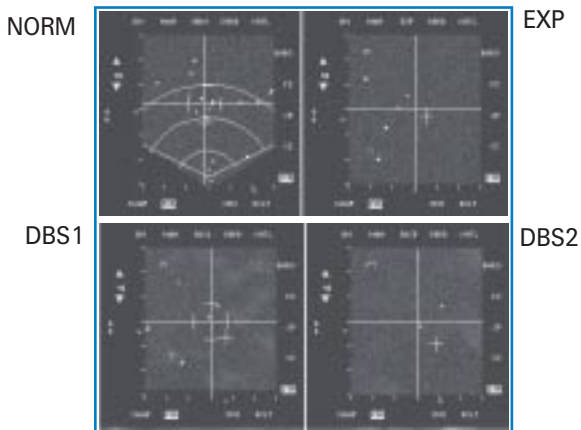

Figure 18-10

- Slew the cursors around and notice the movement of the "+" symbol on the radar display. This is called the situation awareness symbol and is the only way you know where the radar picture is relative to the nose of the jet. It is there only to let you know where the radar is pointed relative to the nose of your jet, and is not for locking targets.
- Lock onto a target by pressing **[0]** on the numeric keypad. Again, the cursors will not slew when the radar is locked onto a target.
- Increase or decrease the radar gain with **[Shift][F4]** and **[Shift][F3]** to change the contrast of the radar display. This will improve the contrast of ground features such as hills and roads. Note that changing the radar gain does not immediately change the radar display, so it will take a few minutes to see the results.

These next steps will take you through the STP (Steerpoint) mode:

- Select GM master mode by pressing **[F2]** until "GM" appears in the upper left corner of the radar display.
- Select the NORM submode by clicking OSB-3 on the MFD until the "NRM" mnemonic appears.



3. Go to Steerpoint mode by clicking on the OSB labeled "STP."
4. Select Steerpoint 4 by pressing **[S]** until Steerpoint 4 appears in the DED.
5. Unfreeze the simulation by pressing **[Shift][P]**. Notice as you fly forward how the radar cursors get closer to you. Remember that the cursors are tied to the selected steerpoint, which in this case is Steerpoint 4.
6. Go to the Snowplow mode by pressing the OSB labeled "SP." As you fly along, notice that the cursors are no longer moving closer to you. Snowplow can be used to search for targets of opportunity that are not around your steerpoints. Figure 18-11 shows the GM display with SP selected.

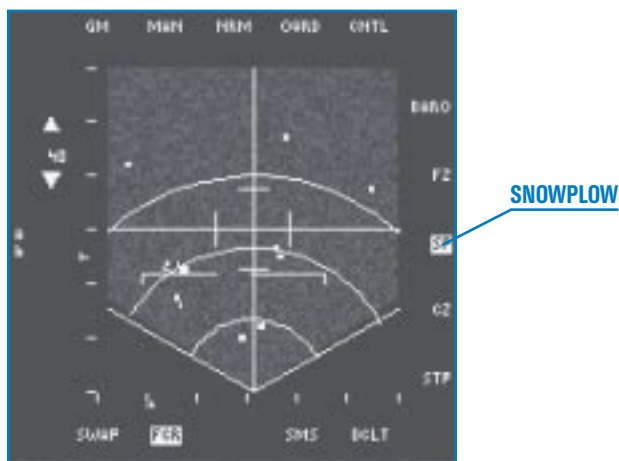

Figure 18-11

In this training mission, you can practice using all of the air-to-ground master and submodes. Once you have mastered the use of air-to-ground radar, you can use it to cue or point your F-16's air-to-ground weapons.

MISSION 19: CCRP WITH UNGUIDED BOMBS

This training mission will discuss how to drop unguided (dumb) bombs using the CCRP (Continuously Computed Release Point) bombing mode. CCRP is a “blind bombing” mode that is used in conjunction with the air-to-ground radar. CCRP is the primary mode used to bomb targets that are not visible due to weather or nighttime conditions. Another important use for CCRP is target cueing. CCRP has excellent HUD steering cues and, when coupled with the air-to-ground radar, can be used to find targets that are beyond visual range. The pilot can find a target on the radar and then drive in following the CCRP steering cues. Once the pilot’s eyes are on the target, a visual bombing mode can be used. Target cueing is the reason that CCRP is used at the start of almost all F-16 air-to-ground attacks. Most F-16 bombing attacks start in CCRP even though the bombs may actually be dropped in one of the other modes.

The other use of CCRP is in pointing the laser targeting pod, which we will explore in a later training mission.

THE CCRP BOMBING TRIANGLE

CCRP works in conjunction with the air-to-ground radar. The pilot finds a target on the radar, locks on and then flies the HUD steering until the bomb is released. The air-to-ground radar cursors in CCRP provide the horizontal range to the target. The FCC (Fire Control Computer) is used to calculate all bomb solutions. Since the FCC knows the system altitude of the jet, it knows two sides of the bombing triangle, the vertical and horizontal component. The FCC then calculates the direct slant range or hypotenuse of the bombing triangle. Figure 19-1 below shows the CCRP bombing triangle.

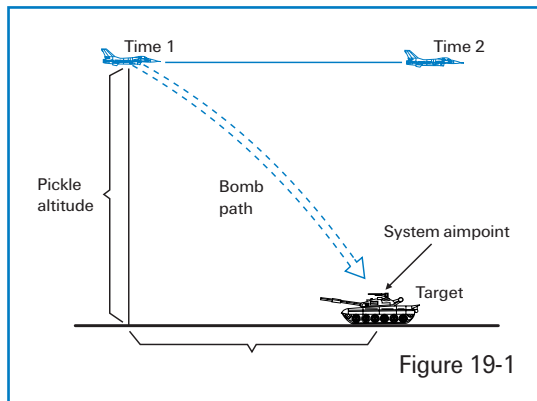

In addition to bombing triangle calculations, the FCC also factors in the characteristics of the bomb itself. For example, the Mk-82 (pronounced “Mark-82”) general-purpose bomb has both high drag and low drag versions. The FCC calculates the bomb range for each bomb type. All the pilot has to do is follow the HUD steering and *consent to release*. It is important to understand that in the CCRP mode you do not hit the pickle button and watch the bomb drop off the jet. Instead, you consent to release the bomb (by holding down the pickle button) and drive

in until the FCC calculates the correct release point. The FCC drops the bomb at this point with consent from your depressed pickle button.



CCRP HUD SYMBOLOGY

The CCRP mode has one major identifying feature, a long vertical steering line that runs from the top to the bottom of the HUD. This steering line, along with a TD box, provides the best air-to-ground target cueing of any F-16 bombing mode. Figure 19-2 shows the CCRP HUD symbology.



Figure 19-2



Figure 19-3

If the target is in the HUD's field of view, a TD box will be over the target. If the target is outside the HUD's field of view, then a locator line will show the bearing and range to the target. Figure 19-3 shows a CCRP locator line pointing to a target that is outside the HUD's field of view. To arrive over the target, the pilot flies the HUD flight path marker over the vertical CCRP steering line. If the flight path marker is over the steering line, then you will fly directly over the target.

Along with steering cues to the target, CCRP also has bomb loft and bomb release cues. As you approach the target, the FCC calculates a bomb release point and then displays a small horizontal tick mark at the top of the vertical steering line. This "release" cue moves down the steering line toward the flight path marker. When the cue hits the flight path marker, a loft reticle appears, signaling that you are now in range to loft the bomb. After the reticle flashes, the release cue appears again at the top of the HUD. This time when it drifts down and hits the flight path marker, the flight path marker will flash and the bomb will release. Figure 19-4 shows the bomb release cue on the steering line.

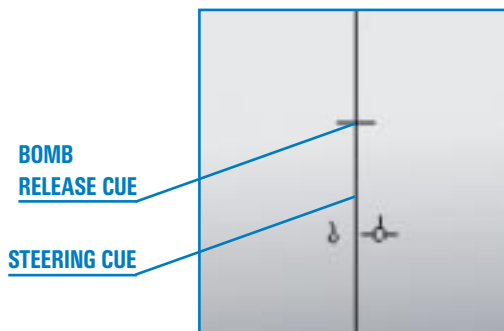

Figure 19-4

To repeat, the release cue will not even appear on the CCRP steering line until the FCC calculates that you can loft a bomb on the target. This means that when FCC calculates that you are in range to loft the bomb to the target, the release cue appears for the first time. It marches down the vertical steering line, hits the flight path marker and the loft reticle flashes. At this moment, you can go to 100% power and loft a bomb that will come off when the jet is in a 45° climb.

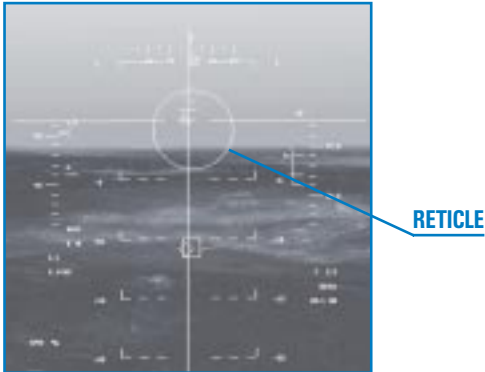

Figure 19-5

Right after the reticle flashes, the release cue will reset to the top of the vertical steering line and again start down to the flight path marker. When the release cue hits the flight path marker, the bomb will be released. Figure 19-5 shows the reticle that flashes in the HUD when you are in loft range.

If you are wondering who thought up this wacky system, I thought the same thing when I first tried to use this system on Wild Cat range in Utah. This is exactly how CCRP works in the F-16. So if you want real, you've got it. If you want something easier, I recommend that you just strafe the target.

TRAINING MISSION OVERVIEW

In this mission, you will practice using the CCRP bombing mode to drop unguided bombs on a ground target.

INITIAL CONDITIONS

- ✦ Airspeed: 400 knots
- ✦ Altitude: 7,000 AGL and level
- ✦ Throttle Setting: Mid-range
- ✦ Configuration: Gear up, 2 Mk-84s, 2 CBU-87s and AIM-120s

MISSION DESCRIPTION

In this mission, you will fly a CCRP attack on several targets. The first is a bridge that is 10 miles on your nose. You will perform level and loft attacks on the bridge with Mk-84 GP (General Purpose) bombs. Next, you will attack moving targets on the road across the bridge using CBU-87s. The CBU is a canistered munition, also called a cluster bomb. The canister opens at a predetermined height, releasing bomblets on the target. Since this type of weapon has a bigger footprint than a normal GP bomb, it is better than a GP bomb for destroying moving targets.



1. Load training mission "19 Bombs with CCRP" from Tactical Engagement.
2. Once the training mission starts, freeze the game by pressing **[Shift][P]** so you can practice using the radar without having to fly the jet.
3. Call up the CCRP mode by pressing **[Backspace]** to bring up "CCIP" in the right MFD. Next, press the OSB above "CCIP" until "CCRP" comes up. When CCRP is up, the GM air-to-ground radar mode should appear in the left MFD.

If GM is not up in the left MFD, press **[I]** until "RWS" comes up in the left MFD. Then press **[F2]** until "GM" appears at the top of the left MFD.

4. If the Mk-84 mnemonic is not present in the right MFD, press the OSB next to CBU-87 to bring up "MK84."
5. Go to Steerpoint 4 by pressing **[S]** until Steerpoint 4 appears in the DED.

Use the following steps to execute a CCRP level attack on the target:

6. When you look at the radar scope, notice that your radar cursors are very close to a small square on the scope. This is the bridge. You're right: it don't look like a bridge. GM radar displays ground targets as radar returns and since the bridge is a small radar target, it only appears as a small radar return on the scope.
7. Slew the radar cursors in the MFD over the bridge using **[↑]**, **[↓]**, **[←]** and **[→]**. Since the radar cursors are tied to the selected steerpoint and since Steerpoint 4 is the bridge, the cursors will be close to the bridge when the mission starts.
8. Lock onto the bridge by pressing **[0]** on the numeric keypad.
9. Press **[Shift][P]** to unfreeze the simulation.
10. Fly the steering in the HUD by turning the jet to place the flight path marker directly on the vertical CCRP steering line. Figure 19-6 shows the flight path marker centered on the CCRP vertical steering line.

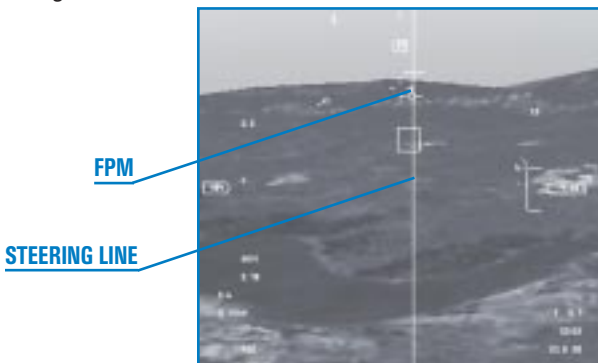
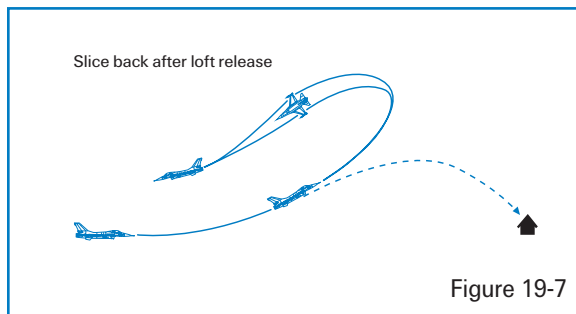

Figure 19-6

11. Reduce the range scale to 20 miles by pressing **[F3]**.
12. When the target gets inside of 5 miles, consent to release the bombs by holding down the pickle button (**[Spacebar]** or joystick button 2).
13. Drive straight for the target following the CCRP steering until the release cue descends down the vertical steering line to the flight path marker. The flight path marker will flash when the bomb is released.

This next attack will be on the same target with the same weapon. This time, however, we will loft the bomb at the target. Notice that the first five steps are the same.

1. Slew the radar cursors in the MFD over the bridge using **[↑]**, **[↓]**, **[←]** and **[→]**. Since the radar cursors are tied to the selected steerpoint (which is the bridge), the cursors will be close to the bridge when the mission starts.
2. Lock onto the bridge by pressing **[0]** on the numeric keypad.
3. Fly the steering in the HUD by turning to place the flight path marker directly on the vertical CCRP steering line.
4. When the release cue appears (2 seconds after the reticle flashes), push the throttle up to full afterburner by pressing **[Shift+]**.
5. Then press and hold down the pickle button.
6. Start a 4-5 G pull in the vertical and ease off the G just before the flight path marker reaches the release cue. Now just fly through the release cue at 1 G. This technique will give you a more accurate bomb because you are not working the FCC so hard.
7. When the flight path marker flashes, roll into a 135° right or left bank and slice back away from the target. Figure 19-7 shows this maneuver.





The next thing you should try in this training mission is using the GMT (Ground Moving Target) air-to-ground radar mode to lock onto moving targets and attack them using CBU-87s. Use the same procedures listed above for both level and loft deliveries. Before starting, switch the air-to-ground master mode from GM to GMT by pressing [F2]. Select CBU-87s by calling up the SMS page on the MFD. When the SMS display is called up, press the button on the MFD next to the Mk-84 label to cycle you through all the loaded air-to-ground weapons. Press this button until "CBU-87" appears. You are now ready to try both level and loft CBU attacks.

MISSION 20: CCIP BOMBING

This mission covers bombing using the CCIP (Continuously Computed Impact Point) symbology. CCIP is a visual bombing mode, which means that you must see the target in order to use it. In CCRP, the FCC calculates a release point and releases a bomb after the pilot consents to release. CCIP, on the other hand, continuously computes the bomb impact point and presents it on the HUD. CCIP displays a HUD cue showing where the bomb will hit if you hit the pickle button at that instant. Hitting the target using CCIP involves doing what F-16 pilots call "putting the thing on the thing." The first "thing" is the CCIP piper, and the second "thing" is the target. If you hit the pickle button when these two "things" come together, you should hit the target.

THE CCIP BOMBING TRIANGLE

In CCIP the F-16 radar is used to get the direct slant range to the target. Figure 20-1 shows the bombing triangle. Note that the hypotenuse of the triangle is calculated directly by the F-16 radar.

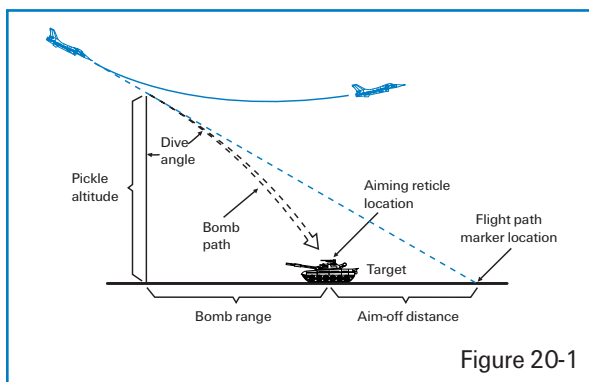

The only additional information needed by the FCC to compute the CCIP bombing solution is the weapon type and the jet's parameters (airspeed, G, etc.). The radar constantly ranges on the ground in front of the aircraft (abbreviated "AGR" for "Air-to-Ground Ranging").

CCIP HUD SYMBOLOGY

CCIP symbology simply consists of what is called a bomb fall line with a circular pipper attached to the end, as shown in Figure 20-2. The CCIP bomb fall line is attached at the top to the flight path marker.

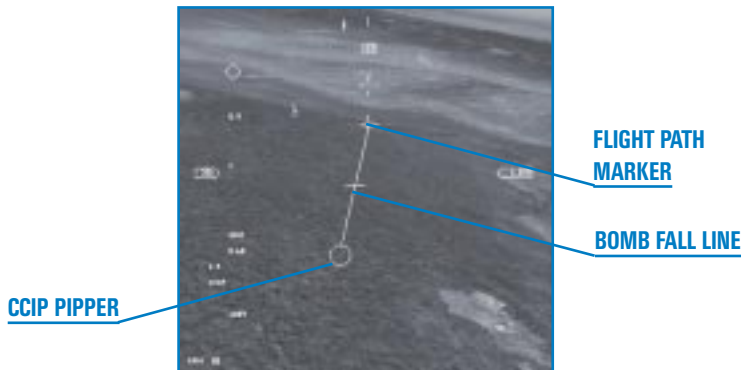

Figure 20-2

The bomb fall line is so named because it represents the path the bomb falls in over the ground. The best technique for hitting the target with the CCIP pipper is to put the bomb fall line over the target. That way the pipper will eventually get to the target and you will have the "thing" on the "thing." Remember that the pipper always tracks up the bomb fall line. Figure 20-3 shows the target through the bomb fall line.

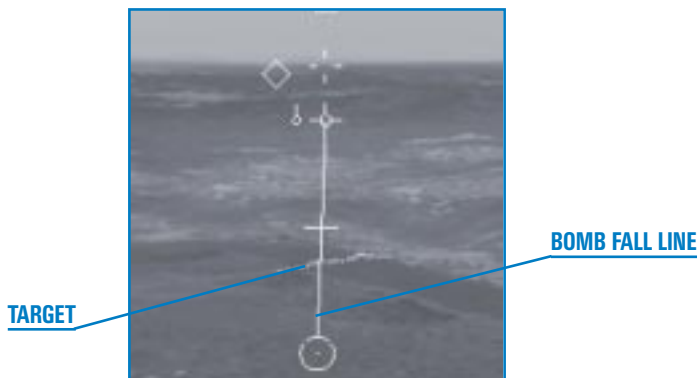

Figure 20-3



This does not mean that you cannot get the piper on the target without placing the bomb line through the target. You can, but it is harder to get the “thing” on the “thing” this way and is also less accurate. It is less accurate because, if you are not smooth with the jet, the CCIP will lie to you. The FCC simply cannot keep up with violent aircraft maneuvers and cannot compute an accurate CCIP solution.

THE CCIP DELAY CUE (OR HOW CCIP BECOMES CCRP)

So far CCIP seems like a straightforward bombing mode. All you have to do is fly the target under the bomb fall line and drive in to the CCIP piper gets to the target. In most cases, this is really all you have to do to hit the target with CCIP. Sometimes, however, CCIP is not so straightforward.

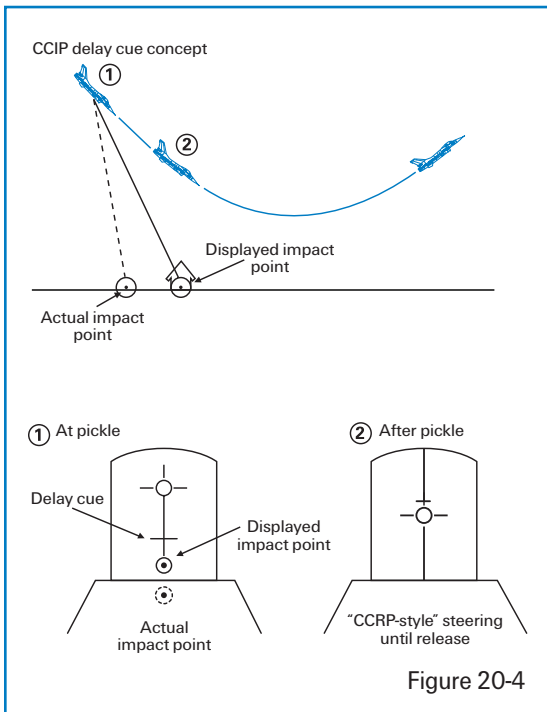

CCIP presents the pilot with the point on the ground where the bomb will fall if it was dropped at that instant. What if that point is not on the HUD, but perhaps underneath the nose of the jet below the HUD? For example, let’s say you call up CCIP while you are flying along straight and level at 20,000 feet. The point on the ground where the bomb will hit is way under the nose and is not visible in the HUD. In cases where CCIP cannot put the real impact point in the HUD, it places a delay cue on the bomb fall line, as shown in Figure 20-4. The delay cue means that the real piper is somewhere below the HUD.

When the delay cue is present, your display will be different after you pickle the bomb. Without the delay cue, the bomb will come off when you pickle and the CCIP pipper will not change. With the delay cue, however, you must hold the pickle button down because the real bomb impact point is somewhere under the HUD. Your pickle is a “consent to release” just like in CCRP, and you must fly closer to the target before the bomb will come off the jet. In fact, after you pickle with the delay cue present, your HUD CCIP symbology will change to a CCRP-like display. Figure 20-5 shows what F-16 pilots call “post-designate CCIP.”

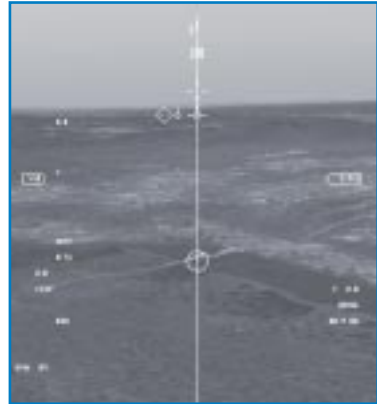

Figure 20-5

You must hold the pickle button down and keep the flight path marker on the vertical steering line in the HUD. When the release cue hits the flight path marker, the flight path marker will flash and the bomb will release. This concept is hard to grasp unless you understand the CCRP mode. Review the previous lesson if you have any questions about CCRP.

TRAINING MISSION OVERVIEW

In this mission, you are set up to practice CCIP bombing with the help of a drone aircraft.

INITIAL CONDITIONS

- ✦ Airspeed: 400 knots
- ✦ Altitude: 7,000 AGL and level
- ✦ Throttle Setting: Mid-range
- ✦ Configuration: Gear up with 12 Mk-82s and 2 AIM-120s

MISSION DESCRIPTION

In this training mission, you will perform a dive bomb attack using CCIP. The target is a runway complex. Before you begin, understand that events will unfold much faster during a diving CCIP attack than they did for a level CCRP attack. Since it is impossible to read all the following steps as you dive down the chute toward the targets, read them before you start. After you practice this attack several times, the following steps will become second nature.



To execute a CCIP dive bomb level attack on the target:

1. Load training mission “20 Bombs with CCIP” from Tactical Engagement.
2. Once the training mission starts, freeze the game by pressing **(Shift)P**.
3. Call up the CCIP mode by first calling up your SMS page on one of your MFDs. Press **(I)** or **(J)** repeatedly until the SMS page comes up.
4. Click on the OSB next to the “A-G” label. This will put you in the CCIP bombing mode.
5. Press **(S)** to go to Steerpoint 4 in the DED.
6. Unfreeze the simulation by pressing **(Shift)P**.
7. Switch to the left view by hitting **(←)** on the numeric keypad. Fly straight and level until the far ends of the runways reaches the left edge of your screen. At this time, switch back to the front view by pressing **(→)**. Start your roll in. Roll the jet 110° in a shallow left-hand slice and pull down toward the target. Figure 20-6 shows a series of HUD views as you roll in on the target.



Figure 20-6

8. As the runway comes into your HUD’s field of view, pick an exact point on the runway complex you want to hit and fly the flight path marker to a point beyond this target.
9. Place the exact aimpoint (target) halfway down the bomb fall line. Stick your flight path marker on the ground by slightly pushing forward on the stick. Do *not* let your flight path marker run along the ground in CCIP. This will cause the pipper to track too quickly toward the target.

10. Hold the flight path marker stationary on the ground. The target should be about equidistant from the flight path marker and the CCIP pipper, as shown in Figure 20-7. You will have a delay cue on this delivery when you first roll in, but it should disappear prior to pickle altitude.

TARGET



Figure 20-7

11. Increase your throttle to 100% for this shallow dive angle. Keep in mind that for steeper dive angles that it is important not to drop

bombs while above .95 Mach since this is a transonic region. Since transonic speeds make it hard to predict the airflow pattern around your jet and thus the bomb separation effects, CCIP bombs may miss the target if dropped above this speed.

12. Make smooth adjustments in bank to keep the bomb fall line over the target and note your altitude as it unwinds and your pipper track.

13. When the CCIP pipper gets to the target, pickle the bomb (Spacebar or joystick button 2).

14. Right after you pickle, start an immediate 5 G wings-level climb to a 30° nose high attitude. This will keep you out of the frag pattern if you pickle above 2,000 feet. The frag pattern is the fragmentation area around the target caused by the bomb blowing up. If you fly into the frag pattern, you may lose an appendage.

15. If you want to see where your bomb hits, press  to switch to the Satellite view, which is great for watching your bombs.

Don't worry too much about avoiding the frag pattern on your first few practice runs, but as you get better at dropping bombs, you should be acutely aware of your planned pickle altitude. The planned pickle altitude will keep you out of the frag.

This delivery is planned to be a 15° dive bomb pass from 5,000 feet AGL with a planned pickle altitude of 2,000 feet. What if you see that you are going to get to your pickle altitude long before the pipper is going to get to the target? Pull the CCIP pipper up to the target. Just before it gets there, ease up on the G. When it hits the target, pickle the bomb and execute your recovery. On this training mission, it is important to just get used to the symbology so don't sweat the bombing parameters too much.

Remember one last point: if the delay cue appears, you must hold down the pickle button and fly the flight path marker over the vertical steering line. The FCC will release the bomb when the release cue intersects the flight path marker.



BOMBING OPTIONS

To release a string of bombs, change the RP (Release Pulses) count in the right MFD to “12” by clicking on the OSB next to “RP.” This number is the number of pulses sent to the bomb racks when you hit the release button to drop the bombs. Since it is “one pass and haul ass” on most combat missions, normally your RP count should equal the number of bombs on the jet.

The next option you have is to change the interval (spacing) of bombs. If you click the OSB next to “25FT,” it will change to 75, 125, 175 and then back to 25. This value is the number of feet at impact between each bomb dropped.

Last, you can also select to drop the bombs in pairs. In pairs, you get two bombs that come off together per release pulse (and you gotta love togetherness). Press OSB-8 to switch from single to pair release and back again.

MISSION 21: DIVE TOSS WITH UNGUIDED BOMBS

This mission will cover the Dive Toss bombing mode. Dive Toss (DTOS) is a visual delivery mode that can be used to “toss” or loft bombs on the target. It is very similar to the CCRP mode with one major exception. Dive Toss is a “visual only” mode that does not use the air-to-ground radar to find targets. Instead, the pilot must have “eyes on” the target and place the HUD TD box over the target. After the TD box is over the target, the target is “designated” with the pickle button, which ground-stabilizes the TD box (fixes the TD box to the terrain). After target designation, a CCRP-like steering line appears in the HUD.

DIVE TOSS EMPLOYMENT

When would you use Dive Toss? Let’s say your mission is to suppress the AAA guns around an airfield so a flight of F-15Es can bomb the runway. Since you want to stay outside of the 2-mile range of the 23mm guns that surround the field, you choose to loft the bombs into the airfield using Dive Toss. With Dive Toss, all you have to do is see the target and put your TD box over the target and designate with the pickle button. Once the target has been “designated,” follow the HUD steering to “toss” (loft) the bombs into the target area. Why not just use CCRP? In CCRP you can find the target with the radar and do the same type of attack, but AAA guns around the airfield will probably not show up on air-to-ground radar display. You will, however, be very visible with the naked eye as the gunfire arcs up from the ground toward your cranium. Why not use CCIP? In CCIP you have to overfly the target. CCIP is more accurate, but in this case Dive Toss will allow you to stand off and deal damage from a safer position.

THE DIVE TOSS BOMBING TRIANGLE

Before going into the HUD symbology, let's take a quick look at how Dive Toss actually works. Figure 21-1 shows the Dive Toss bombing triangle.

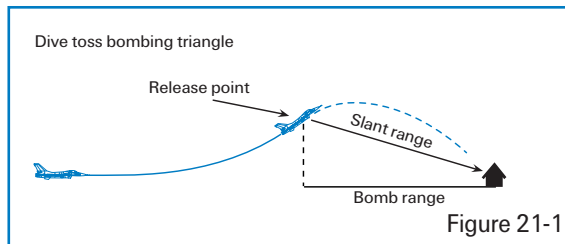

In Dive Toss, the F-16 radar provides the FCC direct slant range to the target (just as in CCIP). After the pilot places the TD box over the target and designates with the pickle button, the F-16 radar reverts to AGR (Air-to-Ground Ranging) and looks straight through the TD box. AGR is a radar mode in which the radar provides slant range information to the FCC for a bomb solution. The FCC uses this slant range data along with other input such as aircraft parameters and bomb type to calculate a release point.

DIVE TOSS HUD SYMBOLOGY

There are two basic Dive Toss HUD displays: pre-designate and post-designate. Remember that Dive Toss is used to toss bombs at a target you can see. Pre-designate Dive Toss is used to place the TD box over the target, as seen below in Figure 21-2.



Figure 21-2



In pre-designate Dive Toss, the TD box is stuck to the flight path marker. To drop a Dive Toss bomb, fly the flight path marker over the target and pickle. When the pickle button is pressed, the TD box detaches from the flight path marker and ground-stabilizes over the target. After the TD box sticks to the terrain, you have a new display in the HUD, post-designate Dive Toss (as shown in Figure 21-3).

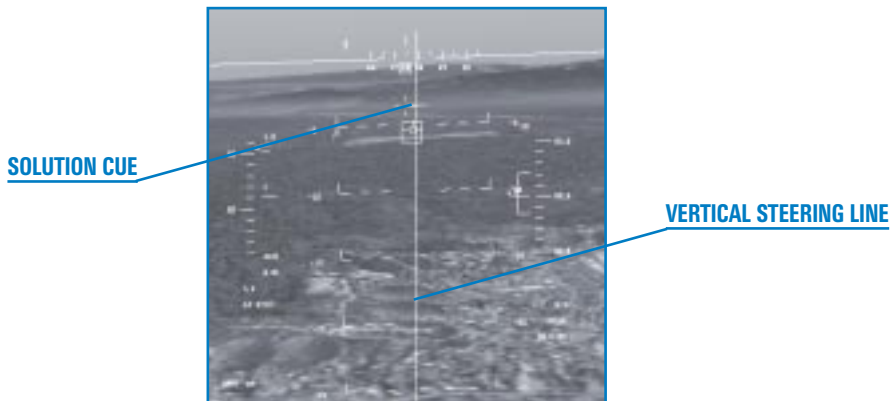

Figure 21-3

Post-designate Dive Toss is essentially CCRP with AGR (Air-to-Ground Ranging). The display to the pilot in post-designate Dive Toss is exactly the same as in CCRP. The only real difference between the two is how FCC computes the bombing solution. Figure 21-3 shows the two main features of post-designate Dive Toss: the vertical steering line and the solution cue. The steering line provides azimuth steering for bomb release. The solution cue appears when you are in range to loft a bomb on the target. This cue will not appear until you are in range to loft a bomb at the target. If you start a pull up to loft the bomb as soon as the solution cue appears, the bomb will release at 45° nose high. The longer you wait to start a loft pull up after the solution cue appears, the shallower your climb angle and the closer to the target you will be at weapons release (this is mechanized exactly the same way as CCRP). The flight path marker will flash when it hits the solution cue and the bombs will release.

Please note one important point about Dive Toss. When you place the TD box on the target and pickle, you are not locking onto the target. In Dive Toss, when you pickle, you are telling the FCC that you are going to drop a bomb on the point on the terrain that is under the TD box. Hopefully, the target is co-located on that piece of earth. If you pickle and ground-stabilize the TD box and miss the target, all is not lost. You can use \uparrow , \downarrow , \leftarrow and \rightarrow to slew the TD box over the target. Remember, though, that Dive Toss is a bombing mode. You still have to get your keister lined up with the HUD steering to hit the target with a dumb free-fall bomb. All the bomb is going to do after it leaves the jet is fall to the ground. When you slew the TD box, you will move the HUD steering. This is no problem if you are far away from the target. If you are close to the target, however, you may not have the time to make a correction to line up with the new HUD steering and get the bomb to hit the target.

TRAINING MISSION OVERVIEW

In this mission, you will practice a Dive Toss delivery.

INITIAL CONDITIONS

- ✦ Airspeed: 400 knots
- ✦ Altitude: 7,000 AGL and level
- ✦ Throttle Setting: Mid-range
- ✦ Configuration: Gear up and 12 Mk-82s

MISSION DESCRIPTION

In this training mission, you are set up to toss (loft) the bomb to the runway complex. You are set up 4 miles out and 90° from the target. Use the following steps to perform this Dive Toss attack:

1. Load training mission "21 Bombs with Dive-Toss" from Tactical Engagement.
2. Once the training mission starts, freeze the game by pressing **[Shift P]**.
3. Call up the Dive Toss mode by first calling up the SMS page on one of your MFDs. Press **[I]** or **[J]** repeatedly until the SMS page comes up.
4. Click on the OSB next to the "A-G" label. This will put you in the CCIP bombing mode.
5. Press the OSB over the "CCIP" label until you see "DTOS."
6. Unfreeze the simulation by pressing **[Shift P]**.
7. Roll into 100° of left bank and pull toward the target. Figure 21-4 shows this maneuver with a series of screen shots.



Figure 21-4



8. As you gain a tally on the runway complex, place the flight path marker just short of your intended bomb impact point. For this attack, just pick a specific part of the runway complex and place the flight path marker below this point.
9. Bring the throttle back to 70%.
10. Let the flight path marker and TD box fly up to the target. Pickle and hold when the TD box hits the target. The TD box will detach from the flight path marker. Remember that you do not need to chase the target with your TD box.
11. If the TD box is not right over the target, make a quick slew with \uparrow , \downarrow , \leftarrow and \rightarrow to place the TD box over the target. Do not get mesmerized slewing the TD box around. You only have about 4 seconds to slew because you are closing in on the target at 800 feet per second.
12. Regardless of whether you get the TD box in the exact place you want or not, after 4 seconds, place your flight path marker over the HUD steering line. The release cue should be present on the steering line so start a 2-3 G gentle pull. When using Dive Toss, you must be *gentle* on the stick or the bomb will not release.
13. As your flight path marker gets through the horizon, go to 100% power (Mil power) by pressing \oplus until you get to 100% on the RPM gauge.
14. When the release cue hits the flight path marker, it will flash and the bombs will come off (given that you are still holding down the pickle button). When the flight path marker flashes, roll 100° and slice back away from the runway (as shown in Figure 21-5).

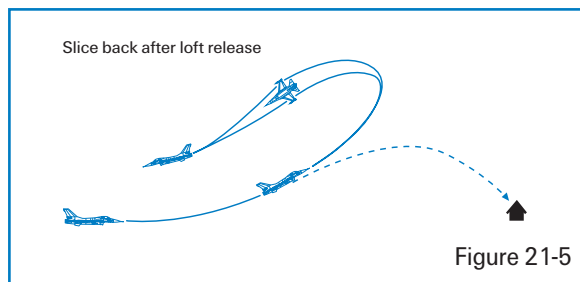

If you do not want to toss the bomb on the target, you can also line up the steering cue and fly straight and level over the target until the release cue hits the flight path marker and the bombs come off.

MISSION 22: 20MM CANNON (AIR-TO-GROUND)

Although the 20mm cannon in the F-16 is primarily an air-to-air weapon, it can be used to attack ground targets. The big problem with using the 20mm gun against ground targets is lethality. The 20mm projectile is small and the muzzle velocity relatively slow (about 2,000 feet/second). Slow and small are a bad combination of attributes for most weapons, but the gun does have a few advantages nonetheless.

The first and foremost is that you are always carrying it. Even if you have already dropped all of your bombs and fired all of your missiles, you still have the gun and 510 rounds. The next advantage is that it is a point-and-shoot weapon, with no locking onto targets, complicated DLZs or anything like that. In modern air combat where you spend quite a bit of your time with your situation awareness down around your knees, a lot can be said for a simple point-and-shoot weapon.

Figure 22-1 shows the Falcon Strafe HUD symbology.

PIPPER



Figure 22-1

Strafe HUD symbology is relatively simple. Place the floating pipper on the target and shoot. The pipper floats because it is placed on the HUD by the FCC (Fire Control Computer). The FCC computes the slant range to the target and aircraft parameters to correctly place the pipper in the HUD. When you are about 8,000 feet from the target, a hat will appear over the strafe pipper to indicate that you are in range.

TRAINING MISSION OVERVIEW

In this mission, you will use the 20mm cannon to destroy a series of ground targets.

INITIAL CONDITIONS

- ✦ Airspeed: 400 knots
- ✦ Altitude: 4,500 AGL
- ✦ Throttle Setting: Mid-range
- ✦ Configuration: Gear up and clean



MISSION DESCRIPTION

This mission starts with the Falcon pointing towards a coastline. A building will come into view near the coast, and near the building is a group of target vehicles. Some of these vehicles are trucks, which can be destroyed with the 20mm cannon. Most of the target vehicles in this mission are tanks. The 20mm projectile will bounce right off the tanks. In the same general area as the tanks should be a few lighter-skinned vehicles to shoot up. The building can also be attacked if you need to practice hitting the broad side of a barn.

This mission is not designed for you to shoot all of these targets on a single pass. After practicing on one set of targets, restart the mission and strafe the next group. By the way, it is probably faster to just fly back around for another run at the target if you miss on the first strafing run. In addition, if all you can find is the tanks, don't worry about it. Since this mission is for practicing your strafe technique, you don't have to actually blow stuff up—only hit it.

Use the following steps to fly a strafe attack:

1. Loading training mission “22 20mm Cannon (A-G)” from Tactical Engagement.
2. Once the training mission starts, freeze the game by pressing **[Shift]P**.
3. Bring up the HSD display in the right MFD by pressing **[J]** until the HSD appears. Next press **[S]** until Steerpoint 4 appears in the DED.
4. Call up guns by pressing **[Backspace]** until you see “STRF” at the top of the MFD.
5. Unfreeze the simulation by pressing **[Shift]P**.
6. Place the flight path marker below the target and set the throttle to 80%.
7. Smoothly fly the pipper up to the target and track the target by gently pushing the stick forward to keep the pipper on the target. You will get a “hat” or horizontal line above the strafe pipper when you get 4,000 feet from the target. This is an in-range cue.
8. Fire a 1–2 second burst and continue to track the target.
9. Start a wings-level 4–5 G pull up to 20° nose high to stay above the frag pattern.

When I first learned to strafe in back in the F-4 Phantom, my instructor always said, “Track—shoot—track.” This technique will keep the pipper (and the bullets) from running through the target. A strafe pass should not look like a World War II movie where the bullets stream out in a long line. Instead, your strafe burst should be concentrated in a tight group over the target. The only way to achieve this type of bullet density on the target is by pushing (bunting) forward to stop your flight path marker from running along the ground.

Some of the targets in this training mission are moving. The correct technique for hitting a moving target is to place the pippier out in front of the target and stabilize your aimpoint on that spot on the ground. Fire a short burst and make a correction off that burst. It is helpful with moving targets to line up your pass along the same axis as the target's motion. In other words, if the target is heading straight north, maneuver to make a pass from south to north. Even if you cannot line up exactly with the target's motion, any attack angle you can get that is less than 90° is helpful.

Remember that since you can strafe anything you see out there, press **[L]** to look closer and find targets. Just remember to get out of this mode (by hitting **[L]** again) before shooting.

MISSION 23: ROCKETS

Rockets are fun to fire and easy to use. That's the good news. The bad news is that it is difficult to hit a target with rockets, and even if you do, they are not very lethal against hardened targets. Rockets are effective against most vehicles including tanks. Rockets come in pods that must all be fired together in a salvo. A rocket pod contains 19 rockets that all fire over the course of about 2 seconds. Rockets are unguided. Rockets can shoot further than the 20mm gun and are more lethal if they hit a target.

PIPPER

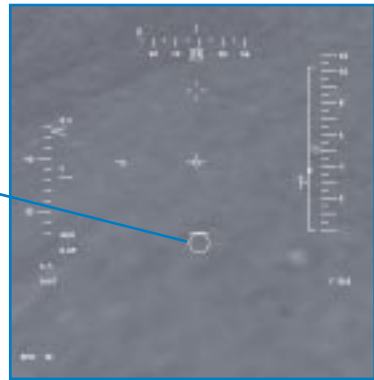

Figure 23-1

The Falcon HUD symbology for strafe and rockets are virtually identical, as shown in Figure 23-1.

A floating pipper is used to aim rockets. The FCC calculates the range to target and aircraft parameters to place a pipper in the HUD. This pipper represents the place on the ground where the rockets will hit if you were to fire at that instant. That's the theory. In reality, rockets are very squirrely and unpredictable. The pipper seldom shows where the rockets will really hit. The pipper is most accurate when you are close to the target and flying the aircraft smoothly.

TRAINING MISSION OVERVIEW

In this mission, you will use rockets to destroy a series of ground targets.

INITIAL CONDITIONS

- ✦ Airspeed: 400 knots
- ✦ Altitude: 4,500 AGL
- ✦ Throttle Setting: Mid-range
- ✦ Configuration: Gear up with rocket pods



TRAINING MISSION DESCRIPTION

This mission starts with the Falcon pointing toward the coastline. A building will come into view near the coast, and near the building is a group of target vehicles. All of these vehicles can be destroyed with rockets. Although rockets can kill the tanks that are near the building, they are not the best weapon for tank killing since they are hard to aim. This mission is designed to let you practice shooting rockets at several vehicles that should be in front of the jet.

Use the following procedures to shoot rockets:

1. Load training mission "23 Rockets" from Tactical Engagement.
2. Once the training mission starts, freeze the game by pressing **[Shift][P]**.
3. Call up rockets by pressing **[Backspace]** until you see "RCKT" at the top of the MFD.
4. Hit **[S]** until you get to Steerpoint 4.
5. Unfreeze the simulation by pressing **[Shift][P]**.
6. You should see some targets near the steerpoint diamond in the HUD. Smoothly fly the pipper up to the target and track the target by gently pushing the stick forward to keep the pipper on the target. A "hat" or horizontal line will appear over the rocket pipper when you get to 8,000 feet. The hat is an in-range cue.
7. Fire the rockets and continue to track the target. It is very important to track the target until all of the rockets have left the pod. To accomplish this, you must push forward on the stick and keep the pipper from running along the ground.
8. Start a wings-level 4–5 G pull up to 20° nose high to stay above the frag pattern.

Please note one important point about firing rockets. If you start firing late, do *not* worry about your rocket pattern. *Pull out of your dive* regardless of where the rockets are going.

Rockets can be fired from further out than the gun and have more penetrating power. They take longer to get to the target, however, and are far more sensitive to aircraft movement while being launched.

MISSION 24: AGM-65 MAVERICK MISSILE

The Maverick missile is an AGM (Air-to-Ground Missile) that is optimized for use against tanks and other armored vehicles. The seeker head in the Maverick missile is similar to a video camera and creates an image of a target that can be viewed by the pilot and tracked by the missile. This image is produced by an IIR (Imaging Infrared) seeker head in the Maverick that presents a heat profile of the target which is very similar to a normal video camera view.

Camouflaged vehicles are extremely difficult to find in the normal visual spectrum but stand out as a hot mass when viewed from the IR (Infrared) spectrum. The Maverick missile takes these hot mass targets and turns them into an IR image that can be tracked by the Maverick. The Maverick target image is displayed in the cockpit on one of the MFDs, as shown in Figure 24-1.

Remember this important point about the Maverick MFD image: the Maverick missile on the rail produces the IIR image in the cockpit. When this missile is fired, the video is lost because there is no datalink from the missile to the aircraft. The Maverick is a "launch-and-leave" weapon that is autonomous after it leaves the rail. When the missile is fired, however, the pilot still sees a Maverick image in the MFD if another Maverick is on the jet because the next missile on the rail is slewed to the target. When the *last* Maverick missile is fired, however, the video in the cockpit is lost. The reason for this is obvious; the Maverick missile itself is the source of the target image in the MFD. Once all the missiles are gone, so is the cockpit video.

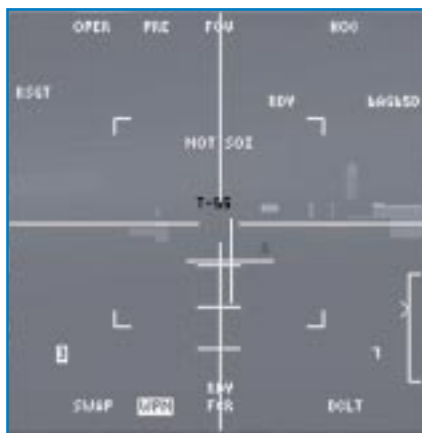

Figure 24-1

MAVERICK DISPLAY

The Maverick MFD display has two major components: the tracking gates and the pointing cross (as shown in Figure 24-2).

TRACKING GATES

POINTING CROSS

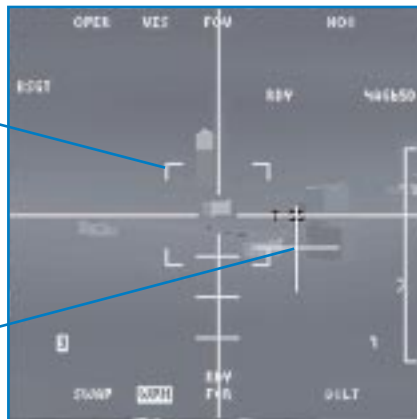

Figure 24-2



The Tracking Gate

The Maverick missile sees the target image and locks on via a tracking gate. This gate is very similar to the radar cursors in several ways. First, the tracking gate can be slewed (moved) over the target by the pilot. Second, it can be slaved to the radar and pointed at the target. And last, once the tracking gate is locked onto the target, it will provide a Dynamic Launch Zone in the HUD for range to the target. The tracking gate locks onto hot targets that are displayed in the MFD. Buildings and other non-vehicular targets are visible to the Maverick along with targets with internal engines. A steel bridge, for example, will be visible to the Maverick because it has been heated passively by the sun. Buildings are visible because of a combination of passive and internal heating. Either way, the Maverick will guide on any target that you can lock on to. You cannot, however, reliably shoot Mavericks at aircraft. The Maverick does not have a guidance computer that can handle the speeds that most aircraft travel. The Maverick, however, can hit a helicopter that is hovering or moving at less than 60 knots.

To lock the tracking gate on a valid Maverick target, simply slew the gate over the target. Once the tracking gate is near the target and the target becomes large enough in the MFD, the brackets around the tracking gate will “breathe” or pulse over the target. This may not occur right after you slew the tracking gate over the target. In *Falcon 4.0*, the tracking gate really consists of two parts. The first part is the intersection of the vertical and horizontal lines in the MFD. The second part is the tracking gate brackets shown in Figure 24-2. After you slew the tracking gate over the target, you must drive in and wait for the Maverick seeker head to determine that this target can be locked up. When the brackets “breathe,” you can lock (designate) onto the target by pressing on the numeric keypad. After you lock, the tracking gate brackets should clamp down on the target. At this time, you can fire the Maverick and break away from the target.

The Pointing Cross

The next symbol on the Maverick MFD display is the pointing cross. The pointing cross is a cue to tell the pilot where the Maverick seeker head is looking in relation to the Maverick missile body. This is important because the Maverick missile seeker head has a conical scan limit of 60° . While the Maverick can see targets up to 60° off axis, it cannot be launched at targets this far off axis. The launch limit is only 30° . This means that you can see Maverick targets in the MFD that you cannot shoot because of the missile launch limit. Figure 24-3 shows the Maverick scan limit and the launch limit.

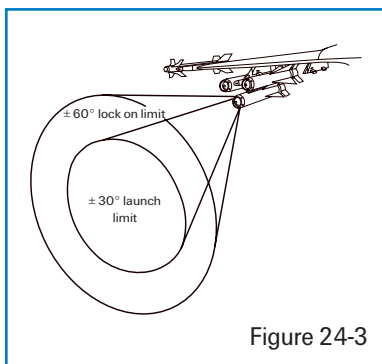

Figure 24-3

A target is centered in the MFD when you lock onto it with the Maverick. When you are looking in the MFD, you cannot tell where that target is in relation to the axis of the missile body without some indication in the MFD itself. The pointing cross shows where the seeker head is in relation to the missile body. The pointing cross works in conjunction with a series of horizontal lines, shown in Figure 24-4. These lines work with the pointing cross to indicate when the missile is 10°, 20° and 30° off boresight.

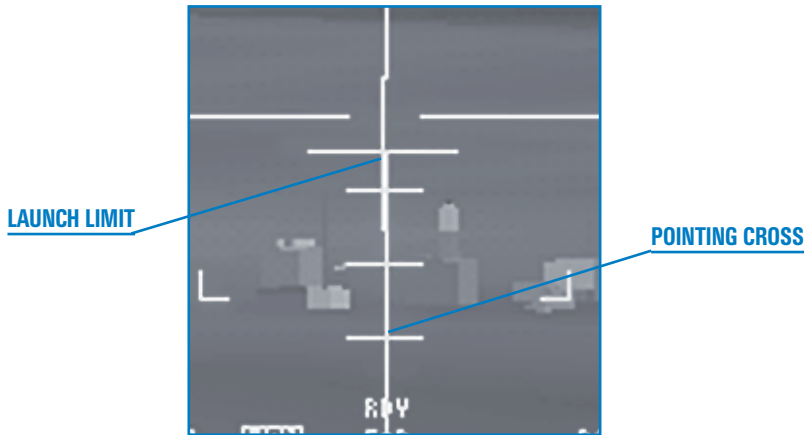

Figure 24-4

MAVERICK MECHANIZATION

When the Maverick missile is selected, an IIR image will appear on the MFD. The Maverick can be selected in several ways, but the simplest way is to press either or until the SMS page appears on the MFD, as shown in Figure 24-5.



Figure 24-5



When the SMS page is called up, press **[Backspace]** to cycle through your air-to-ground weapons. When you get to the Maverick, the video will appear in the MFD. To change to the slave mode, press the OSB on the MFD next to the "BSGT" label on the MFD. This OSB cycles the Maverick between boresight and slave, which are the two basic ways the Maverick can be aimed at the target. In the boresight mode, the Maverick is in a fixed position looking straight out of the HUD. The pilot must find the target visually and point the HUD symbology at the target. Figure 24-6 shows the HUD and MFD in the pre-designate boresight mode. Pre-designate means that the pilot has not designated the target yet.

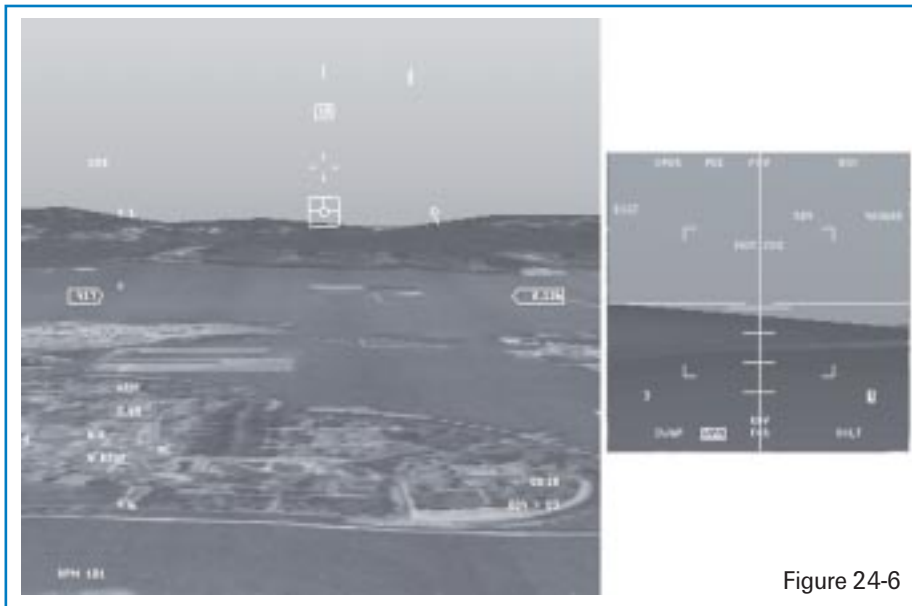

Figure 24-6

Boresight Mode

In boresight mode, the pilot points the TD box in the HUD, designates to ground-stabilize the missile, slews the tracking gates over the target and then designates again to lock the target. After designating the target the first time, the TD box in the HUD ground-stabilizes or fixes itself to the terrain (rather than the HUD). The Maverick can now be slewed or moved over the desired target. To lock onto the target, designate the target a second time once the Maverick tracking gates start “breathing” (pulsing) around the target. If the tracking gates lock onto the target, the Maverick seeker head (and the TD box) will track or follow the target. If the Maverick does not lock onto a target, the Maverick seeker head (and the TD box) will stay fixed to a point on the ground. Figure 24-7 shows the post-designate boresight mode.

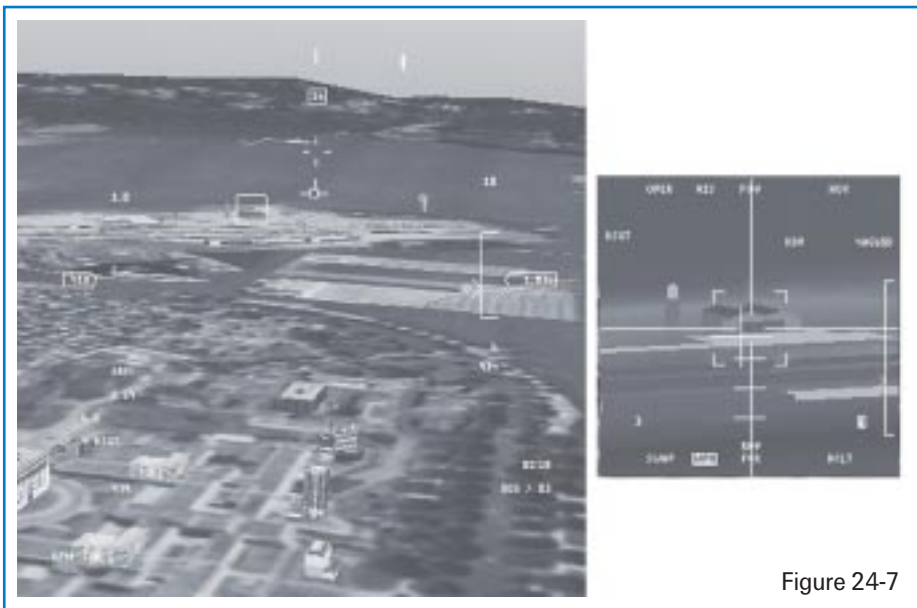

Figure 24-7



To review, locking on the Maverick takes two designates (press **0** on the numeric keypad twice). The first ground-stabilizes the Maverick, and the second locks onto the target when the tracking gate brackets are breathing.

An important Maverick feature is the EXP (Expand) submode. This submode provides 4x magnification of the display. This is a very helpful mode for picking out individual targets. To get to the Expand submode, press the OSB above "FOV" (Field of View) or press **7**. If at any time you have the wrong target locked up, break lock by pressing **6** on the numeric keypad. When you do this, the Maverick stays ground-stabilized and you can slew it on a new target.

Slave Mode

The second way of pointing the Maverick is the slave mode, in which the Maverick is slaved or tied to the air-to-ground radar cursors. Using the air-to-ground radar, the Maverick can be slewed to any target that can be tracked by the radar in GM, GMT or SEA. In the slave mode, you simply have to designate a target on the radar scope. This ground-stabilizes the Maverick seeker head near the target, but it will not lock the Maverick onto the target. To lock the missile on the target, you must slew the Maverick over the target and designate it again after the tracking gate brackets breathe over the target. Slave mode is very similar to boresight except that you are using the air-to-ground radar to get the Maverick missile close to the target. Figure 24-8 shows the HUD and MFD views of the Maverick in the slave mode.

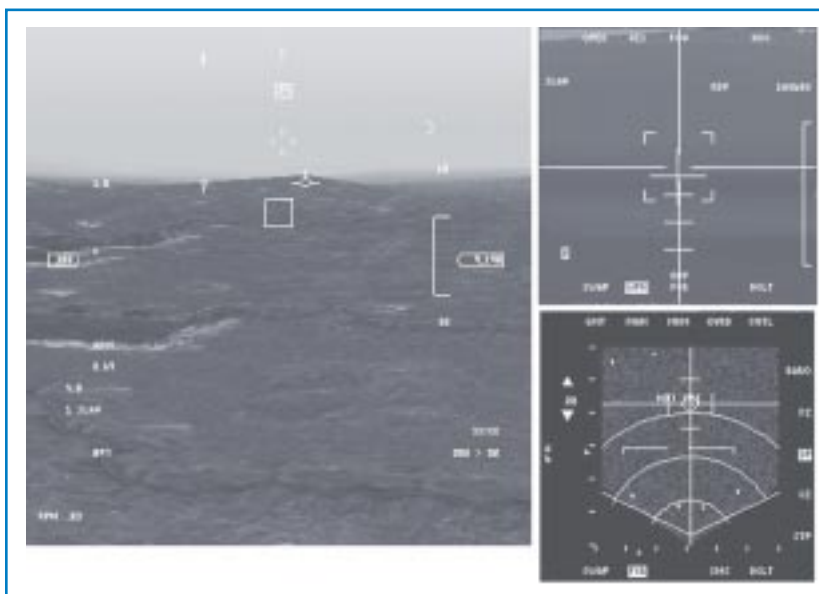

Figure 24-8

The Maverick missile must be locked onto a ground target in all modes of the Maverick before it is fired. If the missile is fired without a lock, it has very little chance of hitting the target. To lock the missile on the target, you must first ground-stabilize the missile by designating (0) on the numeric keypad). The next step is to slew the Maverick directly over the desired target and wait for the tracking gate brackets to breathe over the target. Finally, by designating a second time you can lock onto the target. To break lock or to return the missile to previous mode, press (.) on the numeric keypad.

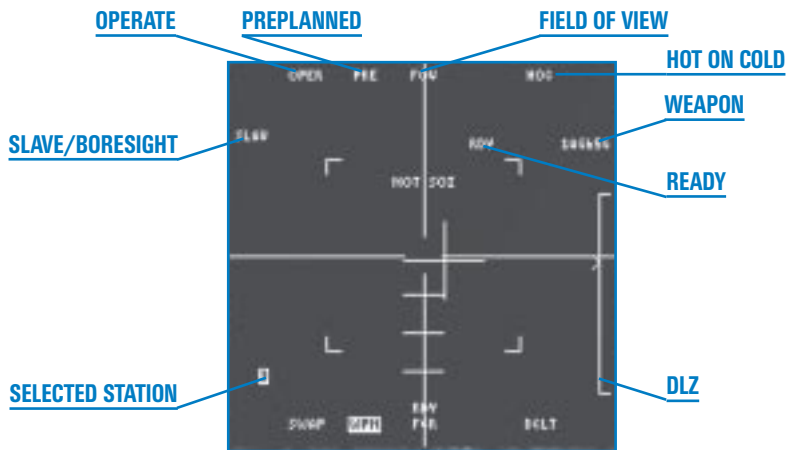

Figure 24-9

The Maverick MFD display has several mnemonics around the outside of the scope:

OPER stands for "Operate" and is always there when the Maverick video is called up.

PRE stands for "Preplanned." This mode is not used in *Falcon 4.0*.

FOV stands for "Field of View."

HOC stands for "Hot on Cold," which sets the polarity of the missile. Since you can only lock onto hot targets in *Falcon 4.0*, this label is permanently set to "HOC."

BORE/SLAVE stands for "Boresight" or "Slave." This label reflects the current Maverick mode.

3/4/6/7 is the number that corresponds to the station where the missile is loaded. Maverick missiles can be loaded on stations 3, 4, 6 and 7. Stations 3 and 4 are on the left side of the jet, and stations 6 and 7 are on the right side. The station that is selected to fire the next missile is highlighted.

RDY stands for "Ready." It indicates that the missile is armed and ready to fire.



MAVERICK DLZ

The Maverick missile uses a similar DLZ (Dynamic Launch Zone) display as the air-to-air missiles. This DLZ has an in-range caret that displays the Maverick's kinematic ability to reach the target. Figure 24-10 shows the Maverick HUD display after a missile is locked onto a target and the Maverick DLZ.

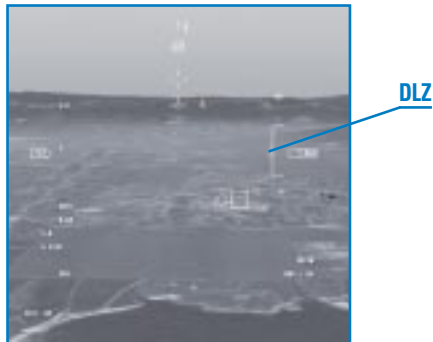

Figure 24-10

TRAINING MISSION OVERVIEW

In this mission, you will practice using the boresight and slave modes of the Maverick missile.

INITIAL CONDITIONS

- ✦ Airspeed: 400 knots
- ✦ Altitude: 4,500 AGL
- ✦ Throttle Setting: Mid-range
- ✦ Configuration: Gear up, 6 AGM-65Ds and 2 AIM-120s

MISSION DESCRIPTION

This mission starts with the Falcon pointing toward the coastline. A building will come into view near the coast, and near the building is a group of target vehicles. Most of these vehicles are tanks, perfect targets for the Maverick missile. This mission is designed to let you practice shooting Mavericks at these vehicles.

Use the following steps to fire the Maverick missile in *boresight* mode:

1. Load training mission "24 Mavericks" from Tactical Engagement.
2. Once the training mission starts, freeze the game by pressing **[Shift][P]**.
3. Bring up the right-hand MFD by pressing **[J]** until you see the SMS display. Call up the Mavericks by pressing **[Backspace]** until you see "6AG65D" on the right side of the MFD.
4. Press **[S]** to select Steerpoint 4 in the DED.
5. Unfreeze the simulation by pressing **[Shift][P]**.

6. Set the throttle to 80% and fly the TD box in the HUD over the diamond in the HUD. The diamond is over Steerpoint 4 while the TD box is where your Maverick seeker head is looking. There will be several buildings near the steerpoint. When you see them in the MFD video, freeze the simulation by pressing **[Shift P]**.
7. Make sure you see some buildings or other targets (such as tanks or vehicles) in the Maverick MFD display.
8. Ground-stabilize the TD box by designating the target **[0]** on the numeric keypad.

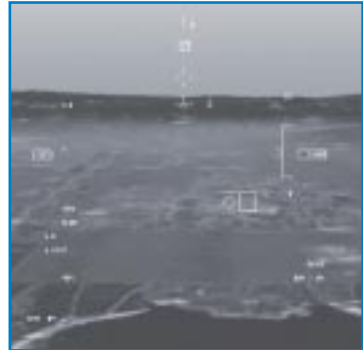

Figure 24-11

9. Slew the maverick tracking gates over a target using **[↑]**, **[↓]**, **[←]** and **[→]**. When the Maverick seeker head sees a valid target, the tracking gates will breathe over the target. Slew the missile seeker while focusing your attention on the cockpit MFD video.
10. As you slew with the simulation in Freeze mode, notice how the TD box in the HUD moves also. In the boresight mode, you usually see the targets first in the HUD and slew the TD box over them and next you look at the video on the MFD. For this training mission, we are doing it out of order.
11. When the target is inside the tracking gates and the gates are breathing, lock onto the target by pressing **[0]** on the numeric keypad. The tracking gate brackets should lock down on the target (stop breathing).



Figure 24-12



12. Ensure that the Maverick is in range by checking the DLZ in the HUD. The in-range caret should be inside the DLZ bracket. If the target is in range, unfreeze the simulation by pressing **(Shift)P**. Shoot the missile by pressing **(Spacebar)** or joystick button 2. If you are not in range, then drive in closer and shoot when you are in-range.

The next series of steps will take you through shooting the Maverick using the *slave* mode. In this mission, press **(Shift)P** often to use the Freeze function to slow down the mission.

1. Load training mission “23 Mavericks” from Tactical Engagement.
2. Once the training mission starts, freeze the game by pressing **(Shift)P**.
3. Call up the Mavericks by pressing **(Backspace)** until you see the Maverick displayed on the MFD.
4. In the left MFD, call up the air-to-ground radar by pressing **(I)** until the RWS radar display is up. Then press **(F2)** until GMT (Ground Moving Tracking) is called up on the MFD.
5. Place the Maverick missile in slave mode by pressing the OSB next to the “BSGT” label on the MFD or by pressing **(I)**.
6. Go to Steerpoint 4 by pressing **(S)** until Steerpoint 4 appears in the DED. In the bottom right corner of the HUD, a readout like “007>4” will appear, which means that you are 7 miles from Steerpoint 4.
7. The GMT radar display should show several moving targets on the scope, as shown in Figure 24-13. They will be easier to see if you reduce the GMT scope size to 10 mile range by pressing **(F3)**. These targets should appear as squares on the scope. Slew the *radar* cursors over one of targets using **(↑)**, **(↓)**, **(←)** and **(→)**.

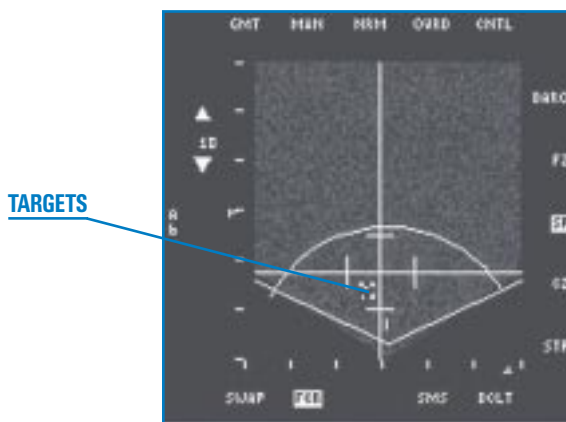

Figure 24-13

8. Once the radar cursors are over the target, lock on by pressing **[0]** on the numeric keypad. This will lock the GMT radar onto the moving target. A diamond will now appear over the target in the GMT display. If you look in the Maverick display, you should see a target.
9. When the Maverick tracking gate brackets start to breathe over a target, designate it by pressing **[0]** on the numeric keypad. When the Maverick is locked on, unfreeze the simulation by pressing **[Shift][P]**.
10. Check your HUD DLZ to ensure that you are in range. If so, fire the missile by pressing **[Spacebar]** or joystick button 2. If not, get closer before shooting. You are in range when the in-range caret on the right side of the HUD is inside the DLZ brackets.

The Maverick missile can be slaved to the GM and SEA modes of the air-to-ground radar to destroy stationary targets and boats, respectively. The procedures for using GM and SEA is exactly the same as the procedure for GMT. Remember that in GM, GMT and SEA, the radar cursors are tied to the selected steerpoint. You can detach the cursors from the steerpoint by switching to Snowplow mode (see Training Mission 18 for more details).

MISSION 25: LASER-GUIDED BOMBS

An LGB (Laser-Guided Bomb) is a free-fall weapon that guides to a laser spot on the ground. Television coverage of the Gulf War featured American laser-guided bombs flying down the air shafts of buildings and straight into aircraft bunkers. The concept is straightforward. The F-16 carries a targeting pod that can track an image of the target. When the target is being tracked, laser energy from the targeting pod bounces off the target and can be picked up by the laser guidance kit in the nose of the bomb. The pilot then flies the jet near the target and drops the bomb using the CCRP bombing mode. In the last phase of the attack, the LGB guides on laser energy reflected from the target.

It is important to keep in mind that an LGB is *guided* but not *powered*. This means that you must get the LGB close to the target just like any other free-fall bomb. In fact, LGBs must be treated exactly like any other free-fall bomb up until release. You must fly your attack steering just as if you were dropping an ordinary CCRP bomb. After the bomb leaves the jet, you must fly a flight path that ensures that the targeting pod stays locked to the target. If it sounds like a lot of work, you're right. Dropping LGBs is not as easy as dropping normal free-fall bombs because you have the extra steps of locking up the target with the targeting pod and then tracking the target after the bombs leave the jet. The good news is that LGBs are very lethal with a very high Pk (Probability of Kill) on virtually all targets. In addition, once you identify and lock onto the target, it is easy to stay locked on.



The targeting pod itself can display and lock onto targets up to 150° in any direction from the nose of the jet. Figure 25-1 shows the gimbal limits of the targeting pod.

I should mention one thing about nomenclature and terms. You will hear the term LGBs and GBUs (Guided Bomb Units) used throughout this discussion. LGBs is a general description of the weapon. GBU, on the other hand, is a designation for laser-guided bombs specific to the U.S. Air Force. For example, a GBU-12 is a 500 lb. LGB. Sometimes, these bombs are referred to as GBU's instead of LGBs, but both of these terms mean the same thing. The targeting pod is the system on the jet that tracks the targets and emits the laser energy to guide the bomb. The targeting pod also provides the picture that is displayed on the cockpit MFD. The targeting pod and a GBU bomb are subsystems of the laser-guided bombing system on the F-16.

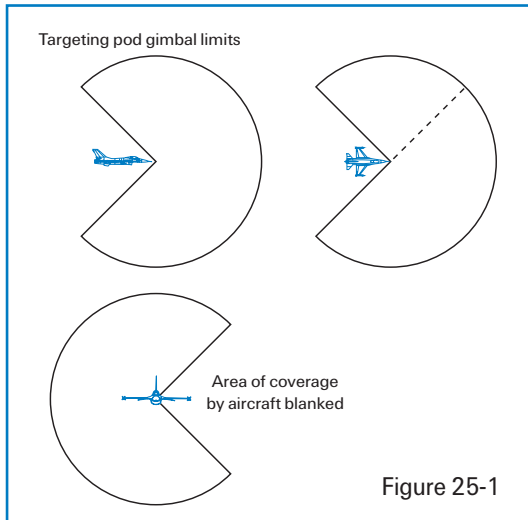

Figure 25-1

TARGETING POD SLAVE MODE

The targeting pod provides an IR image of the target that is similar to the image displayed in the Maverick. Like the Maverick, the targeting pod has both a slave and boresight mode. In the slave mode, the targeting pod is tied to the air-to-ground radar cursors (just like the Maverick). This means that in the slave mode, the targeting pod is always initially looking at the same place as the radar cursors. The only exception is when the pilot selects the SP (Snowplow) mode of the air-to-ground radar.

You will recall that the air-to-ground radar has two basic modes: STP (Steerpoint) and SP (Snowplow). In STP the radar cursors are tied to the selected steerpoint and the radar is looking at

that steerpoint. In SP the radar cursors are detached from the steerpoint and are fixed in the middle of the radar scope. In STP mode, the air-to-ground radar cursors stay fixed to the ground at the position of the steerpoint, while in SP they move along the ground at a set range from the target. The targeting pod is tied to these cursors in both STP and SP. Figure 25-2 shows how these modes work.

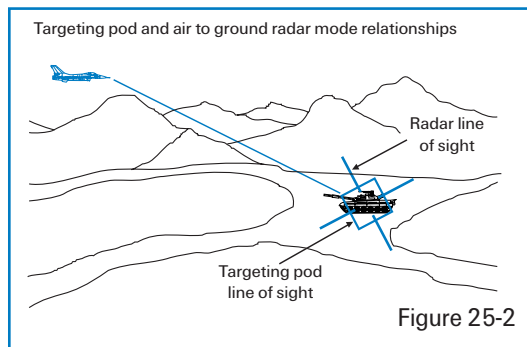

Figure 25-2

Notice that the pod is providing an image of the steerpoint in STP mode and an image that is constantly changing in SP. The important point here is that the targeting pod is always initially looking at the air-to-ground radar cursors. The operative word here is "initially." The targeting pod (like the Maverick) can be slewed around at any time by the pilot. The pod in the slave mode starts out by looking or pointing at the position on the ground that corresponds to the radar cursors. It is better not to lock the air-to-ground radar on a target when using the targeting pod because it may interfere with your ability to search for targets. The radar should only be used to gain an initial picture of the target and get the targeting pod looking in the right area. The pilot can then slew the pod and pick out individual targets with no further action.

The bottom line in the slave mode is that the pilot should slew the targeting pod around to find a target and only use the radar to find the general area. As the pilot slews the targeting pod in the MFD, the laser spot on the ground moves. The bomb has a very good chance of guiding on this ground-stabilized spot without any further action from the pilot. The pilot can, however, raise the probability of kill on the target by locking onto the target. The targeting pod, like the Maverick, will "breathe" (pulse) when it finds a target that it can lock onto. You do not have to lock the targeting

pod on a target, however, to hit it. If you do not lock, though, you must slew to keep the pod (laser spot) on the target through the bomb time of fall to the target.

Figure 25-3 shows the tracking box both before and after the designate.

Don't forget that when you enter the slave mode, CCRP is selected and CCRP HUD symbology will be displayed in the HUD.

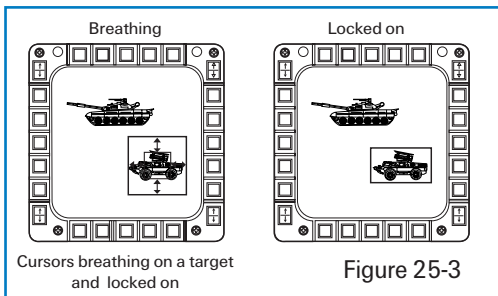

TARGETING POD BORESIGHT MODE

The targeting pod also has a boresight mode that works just like the Maverick boresight mode. The pilot has a TD box in the HUD that is attached to the flight path marker. The targeting pod is looking through that box. Figure 25-4 shows the targeting pod HUD symbology for the boresight mode.

To line the targeting pod up on a target, point the TD box at the target and then designate it. This will detach the TD box from the flight path marker and ground-stabilize the targeting pod over the position on the ground where you designated. If the targeting

**TD BOX ATTACHED
TO FLIGHT
PATH MARKER**

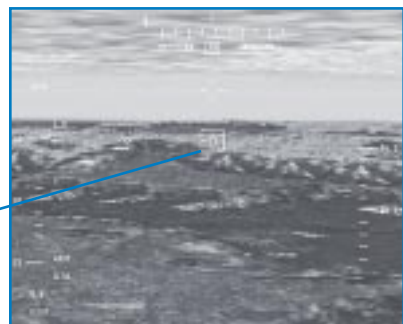

Figure 25-4



pod can see the target at this time, it may jump straight to the lock on mode with this single designate. You will know the targeting pod is locked onto the target because you will not be able to slew the display. This is not a problem, but you may have to break lock on the target and slew your targeting pod to a new target.

After designating the target, CCRP attack symbology will appear in the HUD, as shown in Figure 25-5.

This is different than the slave mode that we have already discussed. In the slave mode, CCRP will come up as soon as you enter the slave mode. In the boresight mode, CCRP symbology will be displayed only after you designate a target.



Figure 25-5

TARGETING POD MECHANIZATION



Figure 25-6

The targeting pod is called up in the same way as all the other bombing modes. One way is to press **[L]** or **[J]** until the SMS page comes up on the MFD, as shown in Figure 25-6.

Once you are in the SMS page, press **[Backspace]** to cycle through all available air-to-ground weapons. When the weapon on the right side of the SMS page reads “#GB##,” you are in the targeting pod mode for GBUs/LGBs. The first # symbol is the number of that particular weapon on board. The next two # symbols are the specific type of weapon on board. For example 6GB12 means that you have two (2) GBU-12 bombs on the aircraft.

THE TARGETING POD DISPLAY

As shown in Figure 25-7, the targeting pod display that is displayed in the MFD looks very similar to a Maverick display.

The targeting pod display has a pointing cross and a tracking gate or box just like the Maverick display. The tracking gate is a simply a box in the center of the display. As we discussed before, the box will “breathe” (pulse) when the targeting pod has the ability to lock onto a target that is inside the gate. Until the tracking gate

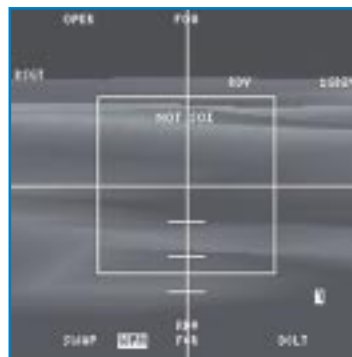

Figure 25-7

breathes over the target, you cannot lock on.

The pointing cross rotates around the display to show you where the target pod is looking relative to the nose of the aircraft. This means that if the pointing cross is centered in the display, then the targeting pod is looking right down the nose of the jet. If it is off to the right side of the display, then the targeting pod is looking to the right of the jet. It is easy to lose track of where the target is relative to your flight path as you gaze into the targeting pod display. A quick glance at the pointing cross should reorient you.

POINTING CROSS

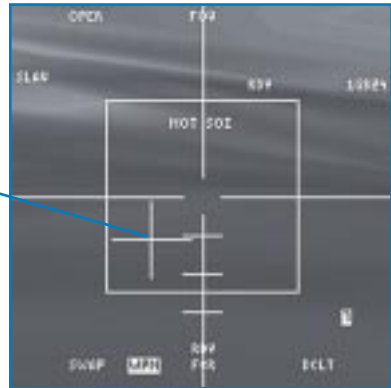

Figure 25-8

The following list explains the mnemonics around the target pod display:

OPER stands for "Operate." This OSB label is always present when the missile video is displayed.

FOV stands for "Field of View." When this mnemonic is displayed, the targeting pod is supplying a normal (non-expanded) picture of the target. If you press the OSB above "FOV," it will change to "EXP," which stands for Expand. Expanded mode provides a 4x expansion of the target area.

3/4/6/7 is the number that corresponds to the station where the bombs are loaded. All stations that are loaded with LGBs will be presented, and the selected station will be highlighted. This is done automatically, and no pilot action is required to select a station.

RDY stands for "Ready." This indicates that the bombs are armed and ready to drop.

NOT SOI stands for "Not Sensor of Interest." This label appears when you cannot control or slew the tracking gate in the MFD. "NOT SOI" tells you that the slew controls are in the HUD. In other words, when you try to slew, you will be moving HUD symbology instead of the tracking gates in the MFD.

An important mnemonic on this list is "FOV/EXP." It is very useful to expand the display. For example, if you want to bomb the control tower on the runway complex, go to Expand, search for the tower and then lock on.



HUD DISPLAYS

When the targeting pod is in the slave mode, the CCRP bombing mode appears in the HUD. CCRP also appears in the boresight mode after you first designate a target.

The CCRP is the only bombing mode that can be used with the targeting pod. Remember that CCRP is tied to the air-to-ground radar cursors. To review, CCRP allows the pilot to bomb the target that is under the radar cursors. CCRP puts a vertical steering cue in the HUD. If you line up the flight path marker with this vertical steering cue, you will fly directly over the target (which is under the radar cursors). As you approach the target, a small horizontal line marches down the vertical steering line as a cue that you are approaching loft range from the target. When this occurs, a circle will appear in the HUD. When the horizontal line descends a second time, it becomes your release cue. The release cue will trigger a bomb release when it intersects the flight path marker.

TRAINING MISSION OVERVIEW

This mission starts with the Falcon pointing at a runway complex. There are numerous buildings around the airfield as well as aircraft on the taxiways.

INITIAL CONDITIONS

- ✦ Airspeed: 350 knots
- ✦ Altitude: 7,500 MSL and level
- ✦ Throttle Setting: Mid-range
- ✦ Configuration: Gear up, 6 GBU-12Bs and 2 GBU-24Bs

MISSION DESCRIPTION

In this training mission, you are 15 miles from an airfield complex. Air-to-ground radar is called up with Steerpoint 4 selected, which is the target complex. The radar cursors should be on the selected steerpoint, and the targeting pod should be in the slave mode. You will lock the targeting pod on a building or aircraft on the airfield complex and then drop an LGB on the target.

Use the following procedures to drop bombs with the targeting pod in the slave mode:

1. Load training mission “25 Laser-Guided Bombs” from Tactical Engagement.
2. Once the training mission starts, freeze the game by pressing **[Shift][P]**.
3. Call up Steerpoint 4 in the DED by pressing **[S]**.

- Call up your LGBs by pressing **[Backspace]** until "6GB12" appears on the right side of the MFD display. When the targeting pod video comes up in the MFD, CCRP will come up in the HUD if you are in the slave mode.

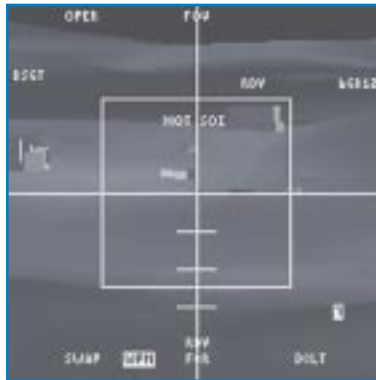

Figure 25-9

- To switch to the slave mode, press the OSB next to the "BSGT" mnemonic or press **[]**. As you switch between boresight and slave modes, your HUD display will change.
- In the other MFD, call up the air-to-ground radar by pressing **[]** until you see "RWS" appear at the top of the left MFD. Next press **[F2]** until "GM" is displayed at the top of the MFD.

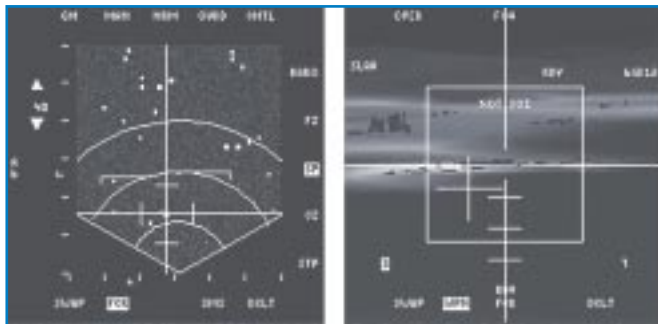

Figure 25-10

- The radar cursors should be on top of airfield radar returns. Bring the radar range scale down to 20 miles by pressing **[F3]**.



8. Go to DBS2 by pressing the OSB above the “NRM” mnemonic on the MFD until you see “DBS2” appear. It is best not to lock the air-to-ground radar on the target. Use the DBS2 radar display to get a long-range picture of the target area. If you are flying in a multiplayer game, you can use DBS2 to divide up the target area among your flight members. Figure 25-11 shows the target area in DBS2.

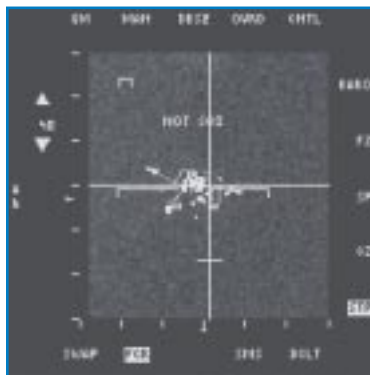
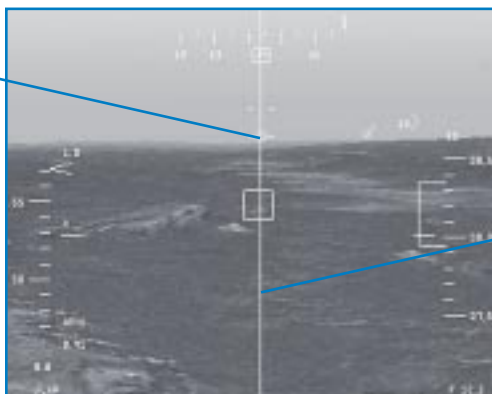

Figure 25-11

9. Unfreeze the simulation by pressing **(Shift) P**.
10. Follow the CCRP steering in the HUD by lining up the flight path marker with the vertical CCRP steering line (as shown in Figure 25-12).

**FLIGHT
PATH MARKER**



CCRP STEERING LINE

Figure 25-12

11. Watch for the tracking gates to “breathe” over the target. If you are sure that the tracking gates are breathing over the correct target, lock on by pressing **[0]** on the numeric keypad. If the gates are not breathing or are breathing over the wrong target, continue to look for your target by slewing the targeting pod.
12. You can use the Expand submode of the targeting pod display to aid in finding the target. Press the OSB above “FOV” on the MFD. It will change to “EXP” (Expand) and will magnify the target area by four times.
13. Fly straight and level and line up your CCRP steering. Hold down the pickle button (**[Spacebar]** or joystick button 2) before the release cue descends to the flight path marker. Keep in mind that the first horizontal line to descend the vertical steering line is the loft cue. The second line is the release cue. Figure 25-13 shows the CCRP mode with the release cue descending the vertical steering line.

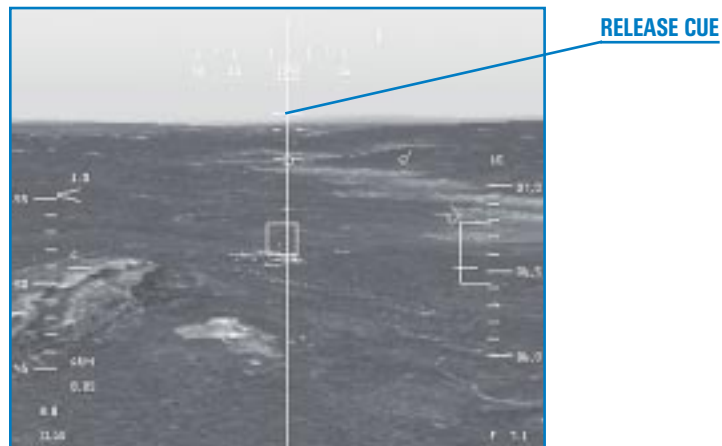

Figure 25-13

14. You should hear the bomb release from the aircraft and the CCRP steering line will fall away to the side of the HUD. At this point, start a left-hand turn using 30°–80° of bank. This “designator turn” is used to keep the laser energy on the target.
15. Watch the targeting pod display in the MFD to ensure that you hit the target. Once the bomb impacts, you are free to maneuver as necessary.

Use the following procedures for dropping a LGB using the boresight mode of the targeting pod:

1. Drive into the target area using the HSD to find the target. Bring up the targeting pod display in the right MFD by pressing **[Backspace]**. The targeting pod will come up in the boresight mode. Next, call up the HSD in the left MFD by pressing **[1]** until the HSD display appears.



2. Select Steerpoint 4 by pressing **[S]**. Steerpoint 4 will be flashing in the HSD.
3. Since the boresight mode is a visual bombing mode, you have to gain sight of the airfield. To do this, place the TD box in the HUD over the diamond in the HUD. You should now see the airfield complex in the targeting pod video in the right MFD. When you are sure you are seeing the airfield, designate by pressing **[0]** on the numeric keypad. This will ground-stabilize the targeting pod and change your HUD symbology to CCRP steering.

Keep in mind that any time you press **[0]** on the numeric keypad, you may lock the targeting pod on to a target. This may not be the specific target that you want. If you get closer to the target and the pod will not slew to a new target, you are locked on. You must break lock by pressing **[.]** on the numeric keypad in order to regain control of your targeting pod.

4. Place your flight path marker over the CCRP vertical steering line and fly towards the target. Figure 25-12 shows this HUD display.
5. Watch for the tracking gates to “breathe” over the desired target (if the pod is not already locked on). There is no rush so if you want to get closer to look for the target, go ahead and follow your CCRP steering and drive in. Remember if you lock the wrong target, you need to break lock (I guess you can tell by now that this happens a lot).

To aid in finding the target, put the targeting pod in Expand submode to magnify the area by four times. Press the OSB above “FOV” on the MFD to switch to EXP (Expand).

6. Fly your CCRP steering and hold down the pickle button (**[Spacebar]** or joystick button 2) before the release cue descends to the flight path marker. Figure 25-13 shows the CCRP mode with the release cue descending the vertical steering line.
7. You should hear the bomb release from the aircraft and the CCRP steering line will fall away to the side of the HUD. At this point, start a left-hand turn using 30°–80° of bank.
8. Watch the targeting pod display in the MFD to ensure that you hit the target. Once the bomb impacts, you are free to maneuver as necessary.

On this training mission, you can restart the mission and try bombing several of the targets available on the runway. In addition to bombing with the targeting pod locked onto the target, experiment with bombing without locking up the target. You will find that it works if you keep checking to ensure that the tracking box stays on the target. This mission is set up to drop an LGB from medium altitude on a level pass. You are far enough away from the target, however, to descend to low altitude and loft the bomb at the target. To execute a loft attack, descend to 1,000 feet AGL and accelerate to 500 knots. When you get to about 4 miles from the target, your loft reticle will come into view followed by your release cue (remember all of that CCRP stuff we already discussed). Start a 30° climb with the CCRP steering centered and the pickle button down. When the bomb comes off the jet, start a designator turn to the left staying just high enough to maintain line of sight with the target. After the bomb impacts, you can descend to a lower altitude.

Lofting LGB is graduate-level stuff so it will probably take you a few tries before you get it down pat. The key to low-altitude lofting is getting the target identified correctly and locked up. After that, the only difficult part is getting the bomb off (you have to follow your CCRP steering for this to happen) and keeping the targeting pod locked onto the target.

MISSION 26: HARM AIR-TO-GROUND MISSILE

The HTS (HARM Targeting System) is used to find enemy ground radars and shoot them with the HARM (High-Speed Anti-Radiation Missile). The HTS consists of a passive receiver that detects radar emissions and displays them on a scope. When radar energy hits the Falcon's HTS antennas, it is processed by an onboard computer that determines the bearing and range of the radar signal along with radar type (SA-3, SA-6, etc.).



Figure 26-1

The pilot can then lock onto these symbols on the HTS cockpit display and fire a HARM. Figure 26-1 shows an overhead view of how the radar energy from a threat radar hits the Falcon and is shown on the HTS display.

The HTS–HARM combination is very similar to the air-to-air radar–AMRAAM combination. With both systems, you detect targets on a scope, lock on and then shoot them when they come within range. There is one significant difference, however, between air-to-air radar mechanization and the HTS. The air-to-air radar has a very high probability of detecting all targets in its search volume. This is not necessarily the case with the HTS. The HTS is not an active system like the radar. In other words, it does not send out any energy to find targets, and will only find radar targets that are radiating. If a threat system has its radar turned off, you may *not* see that system on the scope. You may see the threat because there are two ways that threat symbols appear on the HTS. The first way is that the HTS detects radiating targets within its search volume. The second way is to have it pre-programmed on the display. HTS will display both radiating targets and known radar sites that are pre-loaded into the HTS computer by your squadron intelligence. These pre-programmed sites may or may not transmit but will still be displayed on your scope. The known fixed SAM sites in your mission area are automatically loaded into the HTS display.

The HTS system displays two types of targets: pre-loaded radars and radars that are detected and processed by the HTS computer in real time. You can shoot at both of these target types, but you have a very low probability of hitting any target that is not sending out a radar signal. Remember that the HARM has a very good chance of hitting a threat radar that is in range and transmitting radar energy, but a very poor chance of hitting a threat radar that is not transmitting during the missile's time of flight.



Figure 26-2

HTS MECHANIZATION

The HTS is called up the same way as all other air-to-ground missiles. The most straightforward way is to press **[]** or **[]** until the SMS page comes up on the desired MFD, as shown in Figure 26-2.

Once you are at the SMS page, press **[Backspace]** to cycle through all the available air-to-ground weapons until the HTS appears on the MFD.

THE HTS DISPLAY

The HTS display is used to display and lock onto threat radars. It is easily identified on the MFD because it has an oval display that represents the range footprint of the HARM (as shown in Figure 26-3). Any target that appears inside of this oval display is in range of the missile.

The HTS can detect a radar signal anywhere on the scope, including the 6 o'clock position. Once detected, the threat radar will stay on the scope even if it has shut down and is not transmitting radar energy. The HTS symbols are the same as the ones used by the Threat Warning System. The HTS display, however, has these added features:

- ✦ Bright Symbol – threat is searching or emitting
- ✦ Reverse Bright Video – threat is tracking a target
- ✦ Dim Symbol – threat is known to the HTS but is not currently transmitting radar energy
- ✦ Blinking Bright Symbol – threat is launching a missile

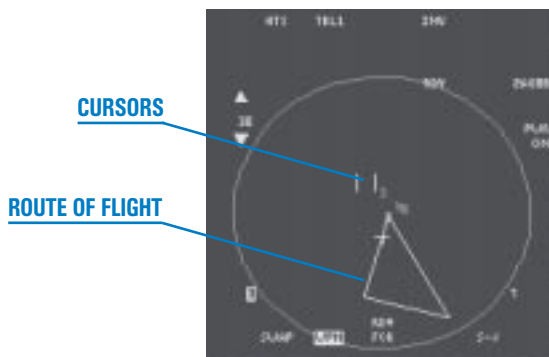

Figure 26-3

For example, if an SA-6 SAM suddenly comes up on your nose at 10 nm, the HTS displays a bright "6" symbol at 12 o'clock and 10 miles (as shown in Figure 26-3A). If it then starts tracking you, it would go to a reverse bright symbol (as shown in Figure 26-3B).

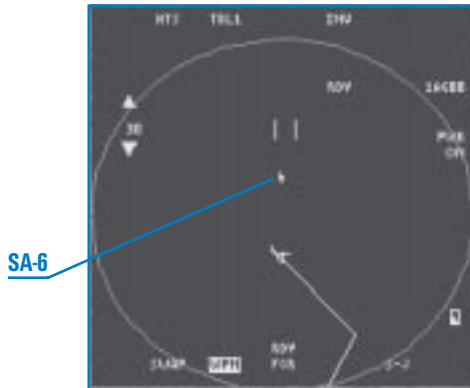

Figure 26-3A

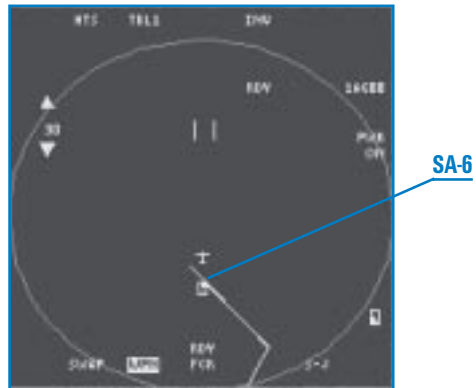

Figure 26-3B

Superimposed on the HTS display is the HSD (Horizontal Situation Display). This allows you to view the proximity of radar threats to your flight route. The HSD provides an overhead view of your planned route.

Around the outside of the HTS display are a series of mnemonics listed below:

HTS stands for the "HARM Targeting System."

TBL1 is a static label that stands for "Threat Table 1."

INV stands for "Inventory." It is not functional on the HTS display.

RDY stands for "Ready." This means that your HARM is armed and ready to shoot.

2AG88 means that two AGM-88 HARMs are called up.

PWR ON means that the missile has power.

S-J stands for "Selective Jettison." Press this OSB to jettison the missile on the selected station.

FCR stands for "Fire Control Computer." Press this OSB to switch from the HTS to the radar.







WPN stands for “Weapon.” Press this OSB to cycle through the AAM (Air-to-Air Missile), AGM (Air-to-Ground missile), A-G (Air-to-Ground) and GUN weapon modes.

SWAP swaps the left and right MFD displays.

is the number that shows the station that the selected missile is loaded on. The lower left corner shows a missile station if the HARMs are symmetrically loaded. The next missile to fire is the highlighted station.

15 is a range number for the HTS. Press the OSBs next to the arrows to increase or decrease the range scale from 15, 30, 60 or 120 miles.

SHOOTING A HARM

To shoot the HARM, you must lock onto the threat symbol on the HTS scope. Do this the same way that you lock onto an air-to-air target. The HTS contains a set of small vertical lines called cursors (virtually identical to the cursors in the air-to-air radar). To lock onto a target, place the cursors over the target using , ,  and , as shown in Figure 26-4.

**CURSORS OVER A
TARGET SYMBOL**



Figure 26-4

Lock onto the symbol by designating the target. Please note that the HTS can be very finicky about locking up targets, so if you can't lock on, just keep trying. Because the symbols may be moving on the scope, you need to anticipate threat symbol movement to get the cursors over the target. When you have the target locked up, a circle will appear over the threat symbol, as shown in Figure 26-5.

LOCKED TARGET



Figure 26-5

The HTS is limited to locking only one target at a time. Since the HARM is a launch-and-leave weapon, once the missile is off the rail, you can immediately break lock on the target you fired on, lock onto a new target and fire the next missile.

HUD DISPLAYS

The HUD displays a missile reticle when the HARM is called up. The purpose of this circular display is to cue the pilot that you have a HARM called up. Since the HARM can be fired at any target within 360° of the Falcon, this missile reticle is not present to indicate any limits of the missile. When the HARM is fired, it will make a high G turn and attempt to go after any target that is locked up on the HTS. This turn burns up a lot of the missile's energy and reduces maximum range. If there are any doubts about the missile's ability to make it to the target, it is far better to turn the jet and put the target on the nose before you fire. As a general rule, the jet will turn faster than the HARM so you can kill the target quicker by turning to put it on the nose.

When the target is locked up on the HTS, a smaller circle will appear in the HUD over the threat radar. If the threat radar is not in the HUD's field of view, a locator line will extend from the gun cross toward the threat radar. Figures 26-6A and 26-6B show a HUD display of threat radars that are locked up and are inside and outside the HUD's field of view.

TARGET IN HUD FIELD OF VIEW



Figure 26-6A

LOCATOR LINE POINTING TO TARGET OUTSIDE OF HUD FIELD OF VIEW

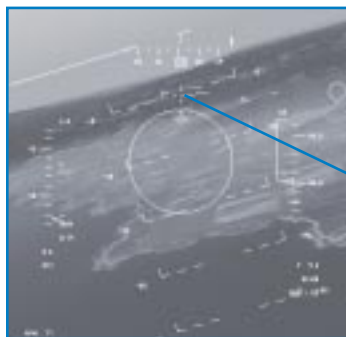

Figure 26-6B



In the above figures, notice that a DLZ (Dynamic Launch Zone) bracket is in the HUD. This bracket appears when a target is locked up on the HTS. The bracket shows the maximum and minimum range that you can fire a missile at the target. Along with the DLZ bracket, you also have a digital range readout in the HUD as shown in the above figures. The range readout and the small circle (or locator line) provide cueing on the location of the threat radar.

TRAINING MISSION OVERVIEW

This mission starts with the Falcon approaching a group of enemy SAMs. These sites are between 10 to 20nm on the nose. Some of the SAMs are radiating constantly, while others are blinking.

INITIAL CONDITIONS

- ✦ Airspeed: 350 knots
- ✦ Altitude: 15,000 MSL
- ✦ Throttle Setting: Mid-range
- ✦ Configuration: Gear up, jammer pod and 2 AGM-88 HARMs

MISSION DESCRIPTION

In this training mission, use the HTS to find and engage targets with the HARM. To shoot HARMs:

1. Load training mission "26 HARMs" from Tactical Engagement.
2. Call up the HTS by pressing `[Backspace]` until the HTS display is called up on the MFD.
3. As you drive in towards the coastline, threat symbols will appear on the HTS display. The threats that are bright indicate that they are radiating. Freeze the simulation by pressing `[Shift][P]`.



Figure 26-8

4. Lock onto the nearest radiating threat by placing the HTS cursors over the target using **↑**, **↓**, **←** and **→**. When the cursors are over the target, lock on by pressing **0** on the numeric keypad.
5. Check that the threat radar is in range by noting the position of the carat on the HARM DLZ bracket in the HUD. In addition, if the symbol is in range, it should be inside the range footprint oval on the HTS scope. The range oval is a dim circle on the HTS scope. The circle is solid if the range on your scope is 30 nm or greater and dashed if the range is at 15 nm.



Figure 26-9

6. Unfreeze the simulation by pressing **Shift P**.
7. Fire the missile by pressing **Spacebar** or joystick button 2. The aiming circle in your HUD is primarily used as a visual indication that HARMs are the active weapon. HARMs are amazingly agile, even to the extent that an "over the shoulder" launch is possible.

Remember that the HARM will only guide on the target when the threat is radiating. If the radar target shuts down while the missile is on its way to the target, the HARM will probably miss. In this case, the HARM will attempt to guide toward the target but it will not have the radar signal to provide precise guidance at the end of its flight. If the radar goes down and comes back up during the missile's flight, the Falcon HARM has a slight chance of reacquiring the radar signal and hitting the target.

CHAPTER

6



AIR-TO-AIR
REFUELING

Air refueling is one of the more challenging tasks facing a new fighter pilot. The first time I approached a tanker, I couldn't believe that they really wanted me to fly that close to a big airplane with the intent of hooking a pipe between us. My first experience with this process was in the venerable F-4. I approached the tanker with the enthusiasm of youth. This couldn't be too hard, I thought; I'd already mastered formation flying and basic fighter maneuvers (or thought I had). But it turned out to be very hard, and I flew away from the tanker wishing that I would never have to do it again. The F-16 and A-7, which came later in my career, seemed easy to refuel compared to the F-4. I'm not sure, though, if it was the difference in the jets or I just got better at it. Anyway, now it's your turn to face the tanker.

MISSION 27: AIR-TO-AIR REFUELING

Since *Falcon 4.0* is set in the Korean peninsula, the distances are short compared to the range of the F-16 and air refueling is rarely required. Refueling is available, however, and will allow you to stay in the air longer.

FINDING THE TANKER

The theory behind air-to-air refueling operations is easy to understand. In fact, I'm sure you have figured out from the previous training missions that air combat in general is not much of an intellectual challenge. The challenge comes in the execution, and nowhere is this more apparent than in the difficult task of air refueling.

The first step in air refueling is to find the tanker, and the easiest way to do this is to query AWACS about the position of the closest one. Press **Q** twice to bring up the second AWACS command menu; then press **4** for "Vector to tanker." AWACS will give you a bearing and range to the tanker. In addition, the AWACS will give you an air-to-air TACAN channel for the tanker, which will provide you bearing and range to the tanker on your HSI. When you get the air-to-air TACAN channel from AWACS, simply type it in to the TACAN control panel and select the AA-TR position on the TACAN function knob. In addition, switch to the Backup position on the CNI switch on the Aux Comm panel.



TACAN FUNCTION KNOB

Figure 27-1



INSTR MODE KNOB



Figure 27-2

Next, set the Instr Mode knob to the TCN position. You now have the bearing and range for the tanker verbally from AWACS as well as on your HSI. As you follow this steering, the KC-10 tanker should appear on the radar. When a target does appear on the radar, lock up the target and check the range and bearing to ensure that it lines up with the HSI steering.

By the way, you do not have to use the air-to-air TACAN. Another technique is to just keep asking AWACS the bearing to the tanker and follow that bearing by turning to that heading. For example, AWACS might say, "Bearing 090, angels 19, 20 miles, 110 Yankee." This call means that if you turn to a heading of 90° , you will point at the tanker. The last part of the call gives you the air-to-air TACAN channel of the nearest tanker. Figure 27-3 shows the bearing to the target as seen on the HSI in the air-to-air TACAN mode.

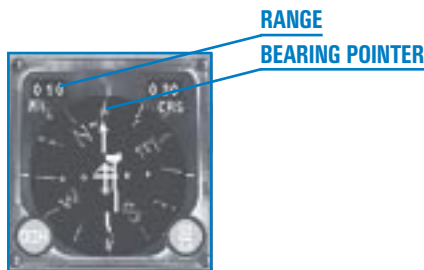

Figure 27-3

This training mission will place you directly behind a tanker so you can make repeated attempts at hooking up. Finding the KC-10 tanker is not part of this mission, but if you want to practice finding the tanker, fly away from the tanker and then use the AWACS and TACAN to get back in position to refuel.

CLOSING ON THE TANKER

Once you find the tanker, the trick is to get behind it in a position to refuel. Since the tankers fly large racetrack patterns, most of the time they will be straight and level. To make the tanker fly a predictable flight path, request fuel from the tanker. Press **[Y]** to bring up the tanker command menu and then press **[1]** for "Request refueling." Once you request fuel, the tanker will slow to 300 knots and fly a large racetrack pattern. When you get about 1 mile behind the tanker, tell the tanker you are ready to refuel. Press **[Y]** and then press **[2]** for "Ready to refuel." The tanker should lower the air refueling boom at this point (if it is not down already).

It is important to control your overtake as you approach the tanker from 6 o'clock. Remember that overtake is how fast you are closing on (or overtaking) a target. Since overtake is calculated using the radar, you must have a radar lock on the target in order to get an overtake readout in the HUD (as shown in Figure 27-4).



Figure 27-4

A good rule of thumb for controlling overtake is to set the overtake at 10 knots per 1,000 feet of range to the target when you are within 1 nautical mile (6,000 feet) from the tanker. This means that you should gradually decrease your overtake with the tanker as you get closer. This may seem difficult, but it is relatively easy since the tanker is flying at a fixed airspeed of 300 knots. If you're behind the tanker at 350 knots, for example, you will have 50 knots of overtake with the tanker (your speed of 350 knots minus the tanker speed of 300 knots equals 50 knots of overtake). The following chart shows range from the tanker and the desired overtake numbers.



Range in Feet	Overtake in Knots
Outside 1 nautical mile (6,000 feet)	100 knots
6,000 feet	60 knots
5,000 feet	50 knots
4,000 feet	40 knots
3,000 feet	30 knots
2,000 feet	20 knots
1,000 feet	10 knots

The key is to keep slowing down as you get closer to the tanker. Once you get inside of 1,000 feet, stay at 10 knots of closure (overtake) or until you are right up on the boom. At that point, move past the boom at walking pace. One last point about the tanker rejoin: it is very hard to judge overtake on an aircraft going straight and level as you approach from behind. Use the radar overtake as a crutch, or you will overshoot the tanker.

GETTING GAS

Once you are under the air refueling boom, you can see the tanker director lights. Figure 27-5 shows the lights and what they mean.



Figure 27-5

Since the director lights are optimized for big airplanes such as the B-52 and C-5, the fore/aft and up/down lights are on the opposite side from what you would expect. In an F-16, the throttle is on the left side of the cockpit while the stick is on the right. The throttle makes you go fore and aft, but the fore/aft director lights are on the right side of the tanker. The stick in the F-16 is on the right side of the cockpit, but the up/down director lights are on the left side of the tanker. No big deal, but be careful not to get them mixed up.

Here is how the lights work. The director lights show you where your jet is in relation to the optimum position. Let's start with the perfect position. If you somehow blundered into the perfect refueling position, the two center lights on both sets of director lights are illuminated. If you are in a perfect up/down position but are too far aft, then the up/down lights on the *left* would have the center light illuminated, showing that you are in the optimum position. The fore/aft lights would have the one of the two farthest lights (forward lights) illuminated telling you to move forward. *Remember that the lights direct you where to go.* They do not show you where you are. If you see a down light, for example, move down.



Figure 27-6



The director lights are important, but it is more important to start your air refueling by looking at the entire tanker and flying a good position under it. In fact, you can air refuel without even looking at the director lights. You should decide on your favorite view option for air refueling. I like to use the HUD Only view (**F1** key).

Once you have received your gas, slow down and disconnect from the tanker. Before leaving the tanker, tell it that you are done refueling by pressing **Y** to call the tanker and then **3** to say you are done.

TRAINING MISSION OVERVIEW

In this mission, you will start 1,000 feet behind the tanker. From this position, you can move into the contact position and practice refueling.

You may want to try this mission first with Autopilot set to Combat. The Combat autopilot will automatically fly for you, so you can get a good feel for what refueling is like. Next, set Air Refueling in the Simulation setup to Simplified. You should only try the Realistic setting on a computer system with excellent graphics performance and rudder pedals.

INITIAL CONDITIONS

- ✦ Airspeed: 300 knots
- ✦ Altitude: 20,000 MSL
- ✦ Throttle Setting: Mid-range
- ✦ Configuration: Gear up

MISSION DESCRIPTION

This mission starts about 2 nm behind the tanker. Use the following procedure to air refuel:

1. Load training mission “27 Refueling” from Tactical Engagement.
2. Press **Ctrl C** to clear the Master Caution light and silence the “BINGO–BINGO” warning.
3. Press **Y** to call the tanker and then **F1** to request refueling.
4. Lock up the tanker on the radar.
5. Drive towards the tanker, keeping the tanker slightly above the level line in the HUD.

6. Your airspeed should be almost identical to that of the tanker at the start of the mission. Push the throttle up slightly to get some overtake. Since you will start about 2 miles behind the KC-10 tanker, watch your overtake. The chart above is very conservative, but it's a good place to start.
7. When you draw to within 1 mile, indicate you are ready to take fuel by pressing **[Y]** and **[2]**.
8. Maneuver gently to have the boom pass directly over your head. The boom needs to be very close to your cranium as you pass, or you will come in too low. Slow your overtake to a walking pace as the boom gets near the canopy. A good rule to remember is to keep your closure speed to 1 knot for every 100 feet. For example, if your HUD reads "023," then your closure rate should be 23 knots.
9. When the boom passes over your head, stop your overtake by pulling very gradually back on the throttle. This should be a very small throttle movement to stop your motion. Add a little power back in once you have stopped your forward motion to keep from sliding back out.
10. Make very small corrections with both the stick and throttle. Patience is required to successfully refuel.

If you miss the contact or start flailing around wildly, resist the urge to shoot the tanker. Instead, pull back on the power and slide back out about 2–4 ship widths and start again.

The bottom line is make small corrections, develop a sight picture of the correct position under the tanker and one last thing... don't get frustrated.

CHAPTER

7



MISSILE THREAT
REACTION

Falcon 4.0 features many lethal enemy threat systems. All of these systems have weaknesses, though, that a good fighter pilot can exploit.

MISSION 28: MISSILE THREAT REACTION

This training mission will discuss procedures for defeating both SAMs (Surface-to-Air Missiles) and AAMs (Air-to-Air Missiles), but first we will talk about missiles in general.

MISSILE GUIDANCE

Both SAMs and AAMs use either IR (Infrared) or radar to guide them to their targets. IR systems guide on the heat generated by the target's engine. The missile has a seeker head that can track the heat from aircraft engine exhaust, and the missile guides autonomously to the target after launch. All IR missiles therefore are "launch and leave," meaning that they require no more input from the shooter after launch. The IR SAMs and AAMs that appear in *Falcon 4.0* are:

- ✦ SA-7
- ✦ SA-9
- ✦ SA-13
- ✦ SA-14
- ✦ Stinger
- ✦ AA-2
- ✦ AA-8
- ✦ AA-11
- ✦ AIM-9

Radar missiles, on the other hand, generally require guidance commands or directions from the shooting platform. There are very few exceptions to this rule for radar missiles. Radar missiles come in two basic types: command-guided missiles and semi-active missiles. Command-guided missiles are fired while the shooter radar tracks the target and sends guidance commands to the missile as it flies toward the target. Figure 28-1 shows how command guided missiles work.

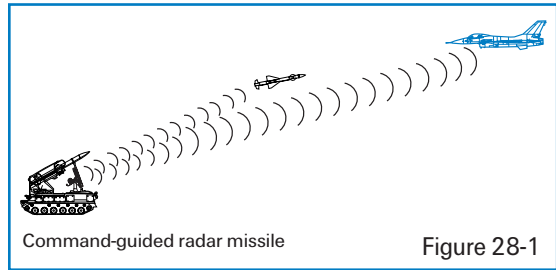

Figure 28-1

The command-guided systems featured in *Falcon 4.0* are:

- ✦ SA-2
- ✦ SA-3
- ✦ SA-4
- ✦ SA-8
- ✦ SA-15
- ✦ Sea Sparrow
- ✦ SAN-4

The other type of radar missile is the semi-active guided missile. This type of missile uses reflected radar energy to guide on the target, and the shooter does not need to send guidance commands. The shooter just tracks the target with a constant wave radar beam. The beam of radar energy acts like a spotlight that lights up the target for the missile to see. Figure 28-2 shows how semi-active guided missiles work.

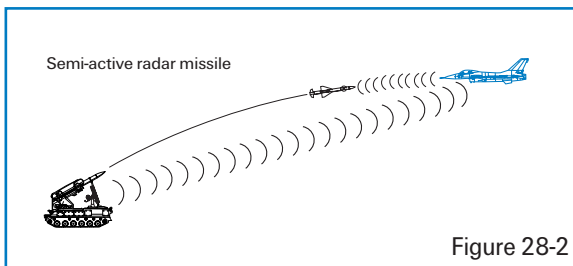

Figure 28-2

The following missiles use semi-active guidance:

- ✦ SA-5
- ✦ SA-6
- ✦ SAN-9
- ✦ AA-7
- ✦ AIM-7
- ✦ AA-10

Another radar guidance technique uses a combination of command guidance and active radar. The AIM-54 Phoenix, AIM-120 AMRAAM and Russian-built AA-10C Alamo use this system. These air-to-air missiles come off the rail and get command guidance until they are close enough to track the target with their own onboard radars. At this point, the missile is autonomous and can guide without further assistance from the shooter aircraft. Figure 28-3 shows how these missiles

guide. This type of guidance scheme is needed because a fighter can carry a much bigger radar than an air-to-air missile and can thus track a target further out. In addition, the radar in the missile is on a one-way trip and needs to be far less costly (and is, therefore, less capable) than the radar in the jet.

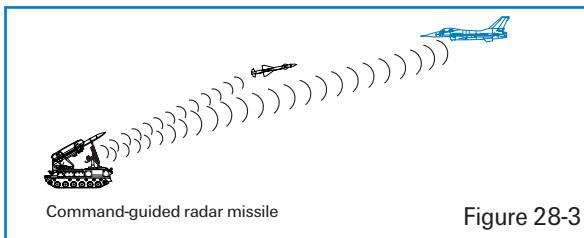

Figure 28-3

MISSILE FLIGHT PATHS

All missiles, regardless of guidance technique, fly a similar flight path to the target. In order for the missile to have the maximum range possible, it must attempt to fly the shortest distance to the target. Missiles achieve this by flying a lead pursuit intercept course, like the one shown in Figure 28-4.

For this reason, when viewed from the cockpit, a missile that is guiding on you will be flying a lead pursuit course and will tend to appear stationary in space as it moves toward an intercept with your jet. If the missile is rapidly crossing your canopy either fore or aft, it is probably not going to hit you.

Remember that the word “miss” is part of the word “missile.” Most missiles do not need to hit your aircraft in order to kill you. They simply need to get

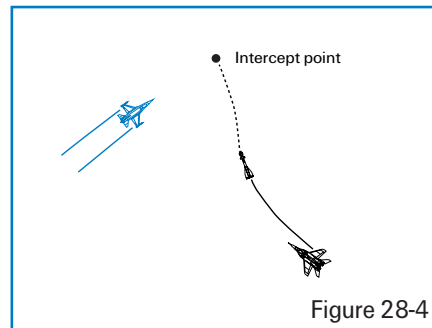

Figure 28-4



close enough for the warhead to detonate within a lethal radius. For some missiles, this radius can be as small as a few feet, while others can kill if they explode up to 100 feet away. Your goal is to stay out of that lethal radius by using a combination of jamming, chaff and flares, and maneuvering.

THREAT WARNING SYSTEM

Before you can successfully react to a missile launch, you must first detect that you are under attack. The TWS (Threat Warning System) in your F-16 consists of a scope and a series of lights on the left side of the cockpit. Figure 28-5 shows your cockpit and the position of the threat scope and associated lights. These lights are not critical with the exception of the Missile Launch light. This light will flash when the TWS detects a radar missile launch.

MISSILE LAUNCH LIGHT



Figure 28-5

The scope is part of the ALR-69 Threat Warning System, which is designed to detect and display radar threats to the pilot. In the F-16, this system uses a series of antennas on the aircraft that detect radar energy. This radar energy is then matched to a specific radar system and displayed on the scope in the cockpit. The scope provides a flashing missile launch indication and a missile launch tone to cue the pilot that a radar missile has been launched.

Notice that I use the word “radar.” The ALR-69 in the jet will *not* display or provide any warning of IR SAMs or IR AAMs. These infrared systems are completely passive and guide on the heat from your engine. In other words, since no radar energy hits your jet, there is no way of knowing that a

missile is in the air. In the case of the IR air-to-air missiles, however, you may get a lock-on indication from the enemy fighter. Fighters may lock onto your jet in order to ensure that they are in proper range for an IR missile shot. You will not get a missile launch indication when an enemy fighter locks onto your jet for an IR missile shot, so be prepared whenever an enemy jet locks onto your Falcon. Figure 28-6 shows the threat warning symbols and which enemy and friendly radar systems they represent. Symbols enclosed in a circle show a launch warning, while symbols enclosed in a diamond are the highest priority.



Search radar	S
Unknown radar	U
Active radar missile	M
Hawk	H
Patriot	P
Naval	
Modern aircraft	
Older aircraft	
Anti-aircraft artillery	A
Surface-to-air missiles	2,3,4,5,6,8,15
Chaparral	C
Launch warning	②
Highest priority target	◇
Nike/Hercules	N

Figure 28-6

For radar systems, the TWS will not only display a unique symbol but will also provide an audio tone for both radar tracking and missile launch. The radar tracking tones are distinct for each different radar system on the battlefield, but the missile launch tone is the same for all radar missiles. In other words, if the TWS detects a missile launch of any kind, it will put out a generic missile launch tone.

The TWS scope itself displays threat symbols on their proper bearing from your jet. Your aircraft is in the center of the scope. For example, if a symbol appears in the 12 o'clock position on the scope, the threat is in front of the aircraft. If the symbol appears at the 6 o'clock position, then the threat is directly behind the aircraft. One important note, however, is that the TWS does *not* display range to the threat. In other words, the 360° rings on the scope do not represent a range scale. The TWS scope has two rings; the outside ring is used to show the pilot that the threat is inside lethal range. Although this sounds contradictory to the statement above, it is not. When a

threat is inside lethal range, the TWS displays that threat inside the lethal threat ring on the scope. Since this "range" is different for each type of SAM, the ring itself does not correspond to a specific range. In Figure 28-7, an SA-8 and an SA-4 ("8" and "4") symbol are both on the scope. The "4" symbol is just inside the lethal ring, while the "8" symbol is outside the ring. Which SAM is closer to you? The answer is the SA-8. Because the SA-4 has more than five times the lethality range of the

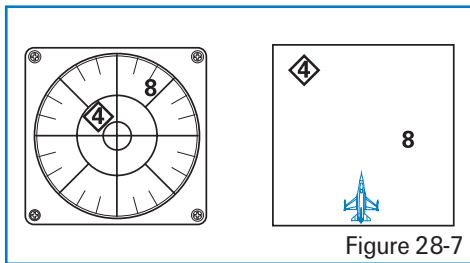

Figure 28-7

SA-8, you are inside the lethal range of the SA-4 and not the SA-8—even though a quick glance at the your scope shows the opposite. The lesson: worry about the SA-4 first. Again, keep in mind that the scope will only display lethal radius for a given threat and not a constant range scale.

COUNTERMEASURES

Falcon 4.0 features a full suite of F-16 countermeasures including chaff and flares and jamming. Chaff consists of small metal strips; when ejected from your plane, they present a false radar target to enemy radars. Drop chaff by pressing **[X]**. Flares decoy enemy heat-seeking missiles. Drop flares by pressing **[Z]**. Chaff and flares are very simple, but they are also very effective.

Press **[Alt][Z]** to run an automatic countermeasures program. This will drop a mix of chaff and flares, which allows you to concentrate on maneuvering your jet. The trade-off is that this will use up your stores more quickly.



In addition to chaff and flares, the F-16 can also carry a jamming pod called the ALQ-131. It is used to jam or confuse enemy radars. Jamming essentially makes it harder for an enemy radar system to track your jet precisely. In the Campaign, you should always fly with a jamming pod because it will help reduce the Pk (Probability of Kill) of enemy radar-guided missiles. Turn on your jammer (if you have one loaded) by pressing **J**.

TRAINING MISSION OVERVIEW

This mission will help you practice missile threat reactions so you can survive both surface-to-air and air-to-air missile attacks.

INITIAL CONDITIONS

- ✦ Airspeed: 400 knots
- ✦ Altitude: 5,000 AGL and level
- ✦ Throttle Setting: Mid-range
- ✦ Configuration: Jamming pod, 2 AGM-88s, 2 CBU-87s and 2 AIM-9Ps (your wingman has a jamming pod and 2 AIM-9Ps)
- ✦ Weapons mode: NAV

MISSION DESCRIPTION

In this training mission, you are surrounded by four threats. To the north is an SA-8, to the east is an SA-6, to the west is an SA-13 and to the south is a MiG-29 armed with AA-10 Alamo missiles. Each threat is co-located with a steerpoint. The SA-8 in the north is Steerpoint 3. The SA-13 in the west is at Steerpoint 4. The MiG-29 in the south will come out of a CAP (Combat Air Patrol) and engage you when you start moving toward Steerpoint 5. The SA-6 to the east is located at Steerpoint 6. This training mission starts with the jet heading north toward Steerpoint 3, the SA-8.

Pick one of the threats and drive towards it until it launches a missile. When the missile is in the air, start your threat reaction maneuvers. Keep in mind, however, that even though you may do everything correctly, the missile may still shoot you down. Your threat reactions will reduce the Pk of the missile but will not reduce it to zero. The missile always has a chance of overcoming your countermeasures and evasive maneuvers. Before you start the mission, select the Graphics tab at the Setup screen. Set Object Density to at least 5 and the Player Bubble to 5. This will ensure that the threats will appear with plenty of warning.

To take on a missile:

1. Load training mission "28 Missile Threat" from Tactical Engagement.
2. Select either Steerpoint 3, 4, 5 or 6 by pressing [S].
3. Drive toward the selected steerpoint until you are engaged.
4. Confirm the missile launch by checking your TWS scope. If it is a radar missile, you will get a launch light and a launch tone from your TWS. If it is an IR SAM, you will hopefully hear a "break turn" call if you have a wingman. Your wingman may be dodging missiles himself and too busy to call out the threat, though. You should always be on the lookout in a combat environment. You will *not* get a missile launch tone or light from the TWS for an IR missile.
5. Since you have an ECM pod in this training mission, press [J] to turn on your jammer and start an immediate descending turn to place the missile on the beam as shown in Figure 28-8. This turn should be at 6–7 Gs. The beam is essentially your 3 or 9 o'clock position.

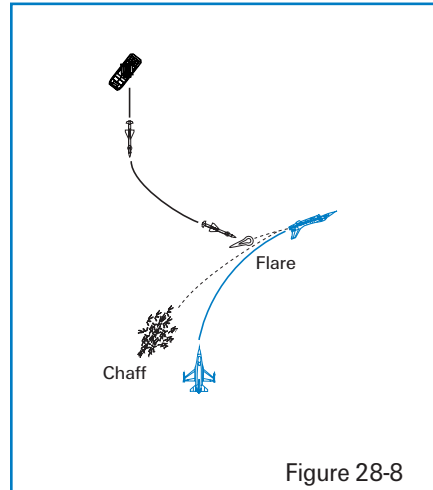

Figure 28-8

There is one important point to note about placing the missile on the beam. When you use the scope to accomplish this maneuver, you will actually be placing the SAM radar site itself on the beam—and not the missile—since the site is generating the radar signal that is giving you the symbol on the scope. This is not a problem. If you do actually see the missile in flight, however, turn to place the missile on the beam. If not, just place the launching SAM site on the beam.

6. If you are below 450 knots, make this defensive turn in afterburner. If you are at 450 knots or faster, make the turn in military power (100% but no afterburner).



7. As you start your defensive turn, drop 2–3 bundles of chaff and 2–3 flares by pressing **[X]** and **[Z]**. If you get a missile launch indication on your scope, just drop chaff and save your flares. Any time you are not sure which type of missile is guiding on you, however, drop both chaff and flares.
8. Get below 300 feet if possible. Don't try to descend this low during your defensive turn. First, complete your turn to the beam and then push the nose of the aircraft slightly forward to get below 300 feet.
9. Gain sight of the missile by switching to the Padlock view (**[4]** key). Step through the visual targets by continuing to press **[4]** until you have the missile padlocked (in sight). Remember that you need to be looking in the general direction of the missile in order to padlock on the missile. Since the Padlock view will always provide a view of a missile that is guiding on your jet, you can monitor the missile as it moves toward you. Figure 28-9 shows a Padlock view of a missile inbound to a Falcon. When using this view at low altitude, exercise great care to avoid hitting the ground.

**INCOMING
MISSILE**



Figure 28-9

10. If the missile continues to guide on your jet, drop 2–3 bundles of chaff and/or flares.

11. As you start to actually see that the missile is a missile and not just a dot on the screen, execute a max G orthogonal break into the missile. This last-ditch break turn is shown in Figure 28-10.

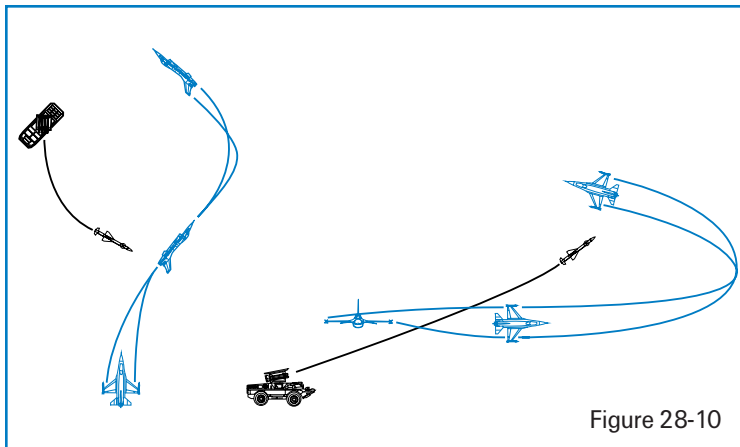

Figure 28-10

12. If you survive the missile attack, confirm that no more missiles are in flight by pressing $\boxed{+}$ on the numeric keypad to cycle through targets in the Padlock view. If another missile is on the way, you will have to repeat the steps you just followed. If there are no more threats, then you can return to the mission.

One last point about missile threat reaction: most SAMs are moving at about Mach 3, which is about 3,000 feet/second. Let's say an SA-6 launches at your jet at 8 nautical miles (about 48,000 feet). Given a missile speed of 3,000 feet/second, you have 16 seconds from launch until impact of the missile on your cranium. My point is that you will not have time to read missile threat reaction procedures and execute them. You have to know them cold and perform many of the above steps simultaneously. This training mission will help you practice these procedures. Keep one more thing in mind: the terrain has a higher Pk than the missile that you are trying to beat.

CHAPTER

8



***BASIC FIGHTER
MANEUVERS***

Offensive BFM (Basic Fighter Maneuvers) is all about maneuvering to shoot down a bandit in the minimum amount of time. In this chapter, we will briefly discuss the theory of offensive maneuvering. More important than the theory, however, are the actual techniques needed to fly offensive BFM. This chapter will give you the step-by-step procedures and techniques for shooting down enemy airplanes.

MISSION 29: OFFENSIVE BFM

I have said this again and again while teaching BFM, and since it seems to help both new and experienced Falcon pilots, I'll say it one more time. It is helpful to think of offensive BFM as a series of fluid rolls, turns and accelerations rather than a collection of set-piece moves. Some of the maneuvers in offensive BFM have names, but the modern-day fighter pilot thinks in terms of driving his jet into the control position from an offensive setup rather than in terms of executing a series of named "moves" to counter the bandit's defensive maneuvering. The great maneuverability of a modern fighters has made a "move-countermove" discussion of offensive BFM obsolete.

In order to stay in weapons parameters and in control of the bandit, you must stay at his 6 o'clock (behind him).

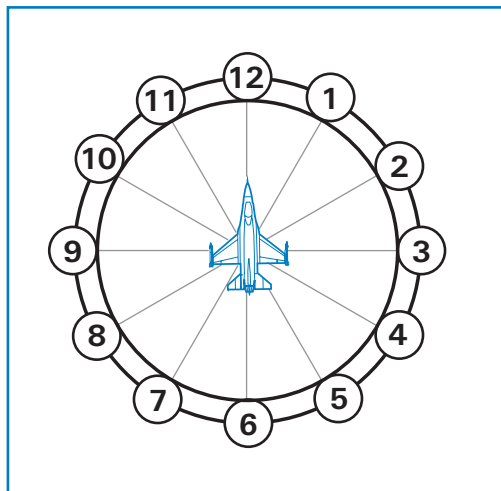

Fig. 29-1



In order to stay at his 6 o'clock, you must keep control of angle-off, aspect angle and range. Angle-off is the angle formed by the difference between your heading and the bandit's heading. When a bandit turns angle off, he creates aspect and range problems for you. Aspect angle is the angle measured from the target's tail to your aircraft. At 0° aspect, your jet is right behind the bandit's jet. At 0° angle-off, you are pointing in the same direction as the bandit. If both of these values are 0° , you are pointing at the bandit from dead 6 o'clock. Figure 29-2 shows how a bandit's turn will change the angular relationship between him and you.

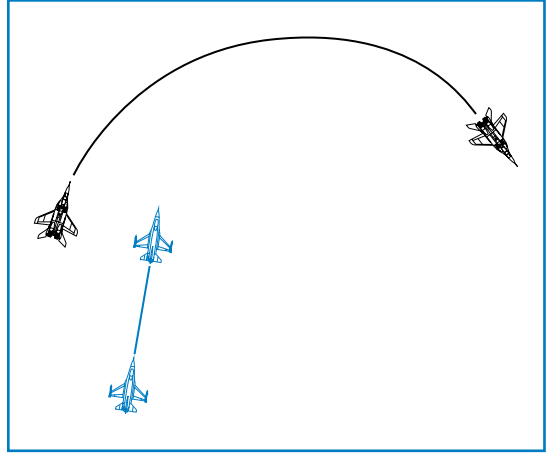

Figure 29-2

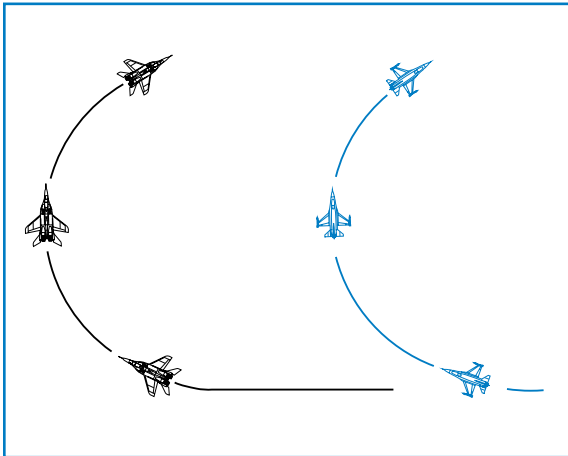

Figure 29-3

To control the "angles" and stay at 6 o'clock, you must also turn your jet. Figure 29-3 shows why an immediate turn by the offensive fighter will not work. If you go into a turn to match the defensive fighter's turn, you will simply turn out in front of him and become defensive.

A turn of some sort is the solution to solving the BFM problems of angle-off, aspect angle and range caused by the bandit's defensive turn. The problem is twofold: how to turn and when to turn. Before covering the when and the how of turning, we need to understand the dynamics of turns in general (which are explained in Training Mission 2). You must understand turns to fly effective BFM.

TURN RATE AND RADIUS

To review the lessons of Training Mission 2, the first two characteristics of turns are turn radius and turn rate. Remember that turn radius is simply a measure of how tight your jet is turning. If you were to look down on the aircraft as it turned, turn radius would be the distance from the center of your turn circle to the aircraft, measured in feet.

Turn rate is the second important characteristic of turning the jet. Turn rate is how fast the aircraft is moving around that turn radius or circle we just talked about (or, how fast an aircraft can move its nose). Turn rate is measured in degrees per second, and is also dependent on Gs and airspeed.

CORNER AIRSPEED

You may think that slowing down to minimum airspeed and pulling on the stick as hard as you can is the best way to achieve a high turn rate. Not so fast! Remember, there is a relationship between airspeed and Gs. At lower airspeed, you have less G available; in other words, you can't pull as many Gs as you get slow. If you get going really fast (above Mach 1, for example), you also lose Gs available. Every fighter has a perfect airspeed for achieving the highest turn rate. This speed is called corner airspeed.

Airspeed also relates to turn radius. Fighter pilots should think in terms of both turn rate and turn radius. Before going any further, we should mention that a fighter with a superior turn rate can outmaneuver a fighter that has a poor turn rate but a tighter turn radius. Fighter pilots have a simple two-word saying: "Rate kills." The ability to move (or rate) your nose is the primary means of employing weapons (which is what offensive BFM is all about). A bandit may have a tight turn circle, but if you can rate your nose on him and shoot, the fight is over. The flaming wreckage will no longer cause you problems. Again, turn rate is more tactically significant than turn radius, but they are both important.

AIRSPEED CONTROL

To achieve the best turn rate and radius, you must control your airspeed. It sounds simple, but I've spent far too much of my life suffering under tremendous G and not turning the jet because I had let the airspeed run away. The message here is "Control your airspeed or you will lose the fight!" There are four ways to control your airspeed in a fighter:

- ✦ Throttle
- ✦ Drag devices
- ✦ Nose position (gravity)
- ✦ Gs



Throttle position controls how much fuel you burn. Drag devices refer primarily to speed brakes. Nose position in relation to the horizon also affects airspeed. Finally, G force causes airspeed to bleed off. Remember from our discussion earlier about exchanging energy for position that no modern fighter (with the possible exception of the F-22) can stay at corner velocity while pulling max Gs at medium altitude. As you pull Gs, you will slow down. It is important, however, to start your maneuvering close to corner velocity because the first turn you make is usually the most important in the fight.

ENERGY

An important BFM concept is energy. Any time you maneuver a jet, it costs you energy. Energy is simply fighter speed and altitude. When you turn a jet at high G, you must give up one or both of these. That's the bad news. The good news is that the defensive fighter also gives up energy to turn and defend himself. Since energy is required to maneuver, this exchange of energy for position in the sky will eventually cost the bandit his jet or his life.

But you've noticed that when you fly that sometimes you can turn and actually climb and gain airspeed. That's true of course in both *Falcon 4.0* and the real F-16. In this case, the only energy that you are expending is the "stored potential" energy called jet fuel.

FLYING OFFENSIVE BFM

OK, how do you actually stay behind an enemy aircraft and shoot him down? Well, it is easy if the bandit flies straight and level or just banks into a gentle turn. When the bandit does a high G turn into you and jams your AMRAAM while simultaneously dropping flares to spoof your Sidewinder, you've got a real offensive BFM problem on your hands.

Here is how the problem develops. When you start from 1.0–1.5 nm back on the bandit and he turns, you will only be in a missile WEZ (Weapon Engagement Zone) for a few seconds. If you cannot shoot him during this time (due to flares or jamming), the bandit's turn will quickly cause you aspect, angle-off and range problems. You will not be able to solve these problems by just driving straight or pointing at the bandit (which is the most common mistake pilots make). If all you think about is taking that one chance to shoot a missile and you do not do any BFM, you'd better hope that your missile turns the sky full of hair, teeth and eyeballs or you will end up getting an AA-11 Archer up the tail.

TRAINING MISSION OVERVIEW

In this mission, you will practice offensive BFM behind a bandit aircraft.

INITIAL CONDITIONS

- ✦ Airspeed: 400 knots
- ✦ Altitude: 15,000 MSL
- ✦ Throttle Setting: Mil
- ✦ Configuration: Gear up and 6 AIM-9s

MISSION DESCRIPTION

This mission starts with the Falcon 6,000 feet behind an Su-27 that should start a defensive turn into you while dropping flares. You need to perform your best offensive BFM to keep a position of advantage and shoot down the enemy.

Following these steps will help you fly successful offensive BFM:

1. Load training mission "29 Offensive BFM" from Tactical Engagement.
2. Since you should always shoot when you have a chance, switch to Dogfight mode by pressing **[D]**. Your radar will change to ACM and your HUD will display EEGS and AIM-9 symbology.
3. Shoot an AIM-9 if the bandit is not putting out flares. If you do get a shot off, don't stare at your missile. If the missile misses, you will have to maneuver. Remember that you are shooting a missile and not a death ray—missiles do miss. If they hit the target all the time, they would be called "hit-tiles."
4. If the bandit is still alive, place your flight path marker behind the jet in lag pursuit as shown in Figure 29-4.

AIRSPEED INDICATOR

FLIGHT PATH MARKER

OVERTAKE READOUT



Figure 29-4



5. Watch your airspeed! If you are not between 330–440 knots, then get there. Be heads up about the bandit's speed. Many a crafty enemy pilot will snap the power to idle to get you to overshoot. Watch your overtake as well as your airspeed. Figure 29-4 shows the place in the HUD where you can read overtake. You must have a radar lock on the bandit to get this overtake readout.
6. Change to the Padlock view (**[4]** key) and then call up the Situational Awareness bar by pressing **[Shift][3]**. This view features a lift line down the middle of the narrow display. This line corresponds the lift vector of the jet. At high G, the jet moves in the direction of the lift vector and thus this lift vector line in the display. If you put an enemy aircraft on this line and pull back on the stick, the target will eventually move into your HUD (if you have the energy to make the turn).
7. Fly in a straight line, letting the bandit turn. Figure 29-5 shows how this looks from an overhead view.

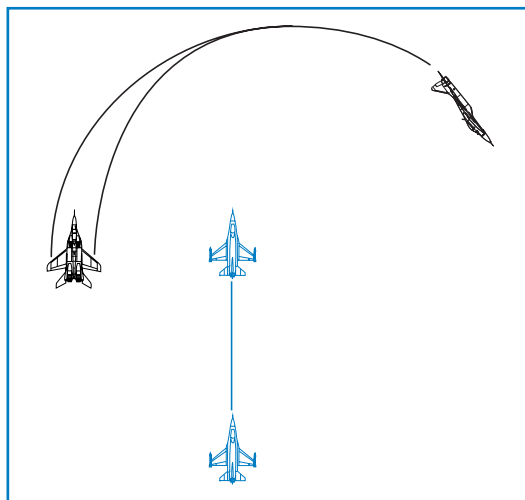

Figure 29-5

8. When the bandit just exits your field of view, start a max G turn into the bandit. Drive in on the bandit in a lag pursuit course or, in other words, keep your flight path marker behind the bandit.
9. Again, watch your overtake. In *Falcon 4.0*, when the wings of the enemy aircraft become distinctive (not a blobby part of the enemy plane), you are approaching within 4,000 feet. When you get to this range, do not carry more than 50 knots of overtake.

10. As you see the wings of the bandit come into view, pull the nose to lead pursuit and take a shot with your cannon. Figure 29-6 shows this position.



Figure 29-6

11. At low aspect (when your fuselage is aligned with bandit), throttle position controls overtake so be careful where you park your throttle in full AB or you will ride that big Falcon engine right past offensive into defensive BFM. Conversely, if you hear the low speed warning tone, you better bring the nose down gently or you might deep stall.

The two biggest factors in offensive BFM are airspeed and nose position. You must be at corner airspeed until you close with the bandit. Once you can make out details of the bandit aircraft such as the wings, you are within gun range and must match speeds with the bandit.

MISSION 30: DEFENSIVE BFM

Defensive BFM is very straightforward once you actually detect that you are under attack. Most fighter pilots throughout the history of air combat, however, have been shot down by adversaries that they did not detect until it was too late. This training mission will discuss what to do when a bandit appears at your 6 o'clock.

The first thing you need to do on defense is create BFM problems for the bandit. Recall how difficult it is for you to stay behind a well-flown aircraft when you try to fly offensive BFM. What's the secret of becoming hard to kill? First and foremost is creating offensive BFM problems for the bandit. Simply, put your lift vector right on the bandit and turn a max G at corner velocity. Figure 30-1 shows why this type of turn creates problems for a bandit.

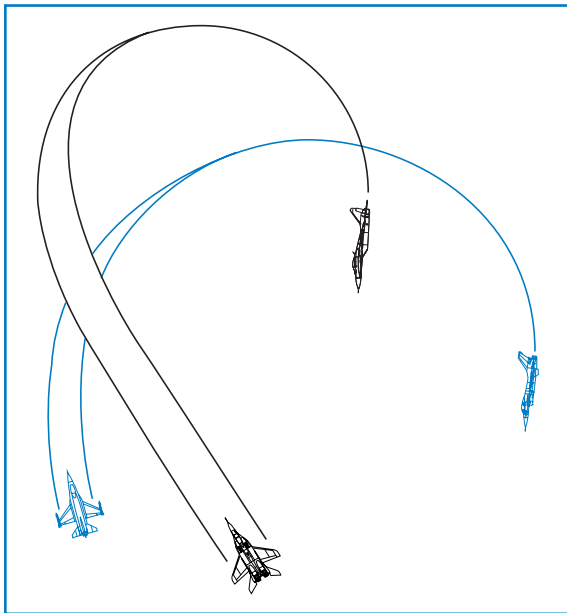

Figure 30-1

Notice how the turn in Figure 30-1 causes angle-off and aspect to build and also rapidly decreased the range. This type of turn forces the bandit to make a move and, more importantly, it forces the bandit to make just the right move. Any time you force your adversary to react quickly and correctly to your maneuvers, there is always a chance he will make a human error. The idea here is to make your best defensive move and force the bandit to do some good offensive BFM. A lame defense will invite contempt, along with sudden death. What could be worse? How about a long, slow ride in a chute with plenty of time to reflect on your shortcomings? If the bandit shoots you down, make him earn it.

Anyway, the fundamental building block of all good defensive BFM is the initial defensive turn. Figure 30-2 shows two views of the turn that we saw in Figure 30-1. In order to create the greatest BFM problems for the bandit, you must put your lift vector right on his noggin and pull hard. You can get your lift vector right on the bandit by using the Extended FOV, Padlock or Virtual Cockpit views.

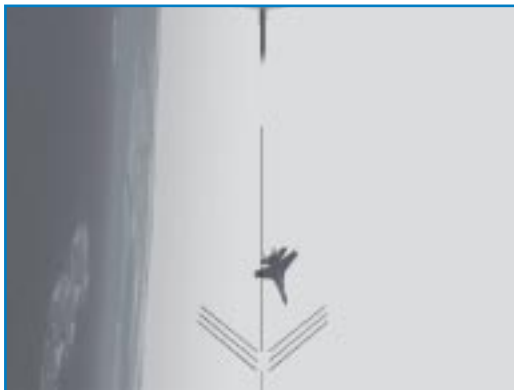
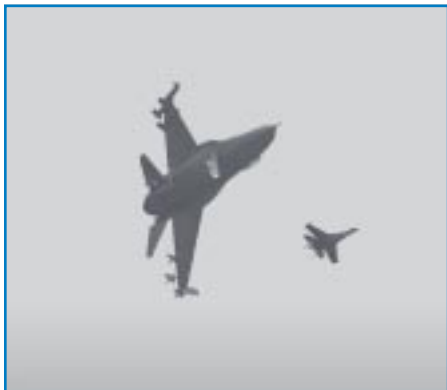

Figure 30-2

This turn must be performed at corner airspeed for all the reasons that I have stated before. But just in case you forgot, I'll cover it again. Turning the jet at corner airspeed will give you the best turn rate (how fast you move the nose of the jet around the circle) and the tightest turn radius (how small a circle you are carving in the sky). Radius is particularly important on defense because a tight turn radius may cause the bandit to overshoot your jet and place him out front of you.

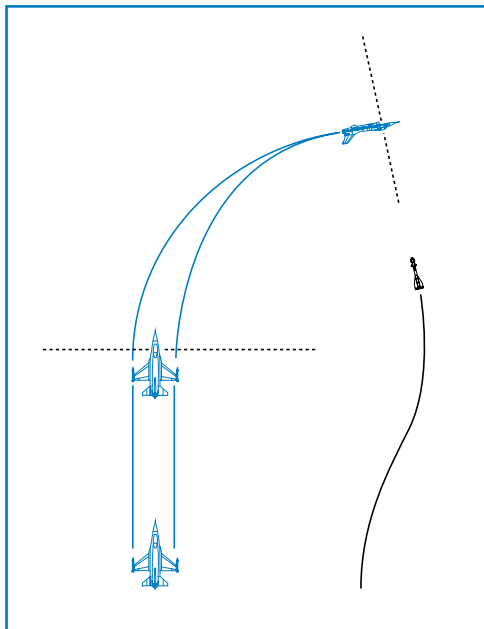

Figure 30-3

So that's about it for the theory of defensive BFM: turn at corner airspeed with your lift vector right on the bandit. Simple except for the exceptions. The first exception is the missile exception. If a missile is the air and heading toward your cranium, you have to fight the missile and not the enemy fighter. You cannot out-BFM missiles or cause them to overshoot. Missiles don't mind overshooting you as long as they pass within the lethal radius of their warheads. When a missile is in the air, you must turn as hard as possible to put it on your 3/9 line. Figure 30-3 shows why this is the best place to put a missile.

You can see that keeping a missile on your 3/9 line forces the missile to fly the longest path to reach your jet. This makes the missile work harder to get to you and causes it to lose energy. If you pull the missile past your 3/9 line, the missile will have to pull a smaller lead pursuit angle and it will fly a shorter path to your jet and arrive with more energy. Energy equates to maneuverability and, of course, the more maneuverable the missile, the more dangerous it is.

The other exception to the "pull straight at the bandit at corner airspeed technique" is the gun exception. If the bandit is in range for a gun shot and in your plane of motion with his nose in lead pursuit, forget all that you have read so far. When a bandit is about to take a gun shot, you have to jink. Part of that jink is moving out of plane with the bandit. Pulling straight into the bandit puts you in the bandit's plane so if you are pulling straight into a bandit that is about to gun you—stop. More on defending against a gunshot later.



TRAINING MISSION OVERVIEW

In this mission, you will practice flying defensive BFM against a bandit that starts directly at your 6 o'clock.

INITIAL CONDITIONS

- ✦ Airspeed: 400 knots
- ✦ Altitude: 15,000 MSL
- ✦ Throttle Setting: Mil
- ✦ Configuration: Gear up and 6 AIM-9s

MISSION DESCRIPTION

This mission starts with your Falcon in a position of disadvantage, with the bandit directly at your 6 o'clock and at your same airspeed. We will discuss procedures for doing basic defensive BFM along with steps for defending against missiles heading and gunshots.

Use the following steps to defend against the bandit at 6 o'clock before he makes his missile or gun shot:

1. Load training mission "30 Defensive BFM" from Tactical Engagement.
2. Call up Padlock (**[4]** key) or the Virtual Cockpit (**[3]** key) view to gain a tally on the bandit.
3. Roll the jet into 90° of bank.
4. Drop chaff and flares by pressing **[X]** and **[Z]** while you simultaneously start a max G break in full afterburner.
5. Place your lift vector directly on the bandit.
6. Monitor your airspeed and stay between 330–440 knots. If your airspeed gets below 400 knots, keep the throttle in afterburner but ease off the Gs to stay in the corner airspeed range.
7. As you continue the pull, analyze your turn to see if it's working. If the bandit is moving toward your nose and you are increasing your angle-off and aspect, the turn is working. Stay at corner airspeed and keep pulling. If the bandit keeps moving toward your nose, you will eventually be flying head-on or offensive BFM.
8. If the bandit stays at 6 o'clock, check your airspeed, because you may be going too fast. If you are, extend the speed brakes (**[B]** key) to slow down and put them back in when you get to 440 knots. If you are not too fast, the bandit is staying with you, so prepare to defend yourself with guns.

GUN DEFENSE

When you are close enough to make out the bandit's wings, he's in range for a gunshot. Additionally, when the bandit is in range and within 45° of getting his nose on your jet, get ready to defend yourself against a gun attack. Remember that the gun is an all-aspect weapon and the bandit does not need to be at your 6 o'clock to kill you with his gun.

Perform the following steps to defend yourself against a gun attack:

1. Roll the jet at least 90° and then pull max G to get out of the bandit's plane of motion.

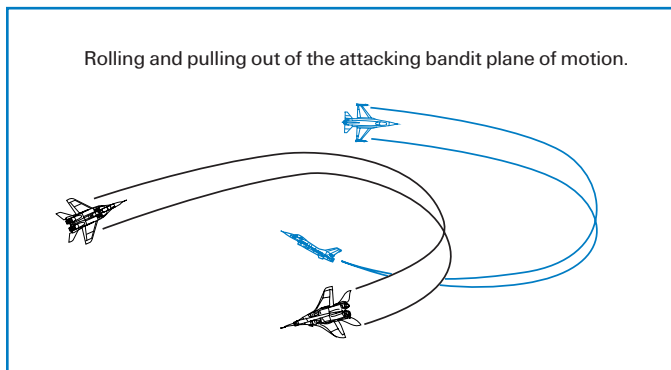

Figure 30-4

2. Bring the throttle back to idle power and put out the speed brakes to rapidly slow down and force a bandit to overshoot you.
3. Hold your new plane of motion for 3–5 seconds. Then make another plane of motion change by rolling another 90° and pulling. The bandit that manages to stay behind you will correct for your new position, so you have to constantly change your plane of motion while you slow down.
4. Continue these maneuvers or jinks at idle power until you get down to 150 knots.
5. Then go full afterburner and take the fight straight up in the vertical and over the top. Figure 30-5 shows this maneuver. Most bandits don't have the thrust-to-weight ratio of the Falcon and will not be able to stay with you during this maneuver. As you go up, be careful not to zoom. You have to keep G on the jet and fly a tight loop all the way back around toward the bandit. If you zoom, you may get a missile stuffed up your tail.

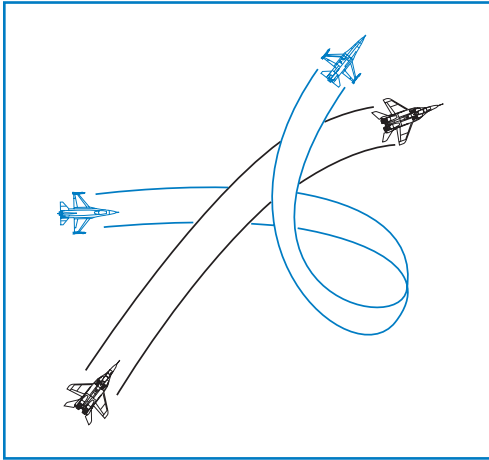

Figure 30-5

These are not magic maneuvers guaranteed to work every time, but these procedures should usually work if executed properly.

Missile Defense

This section covers defending against a missile. When a missile is heading your way, you have no choice but to stop whatever you are doing and maneuver quickly to defend against it.

Follow these steps to defend against a missile:

1. Make a descending turn at max G to put the missile on your 3/9 line.
2. Drop chaff and flares by pressing **[X]** and **[Z]**.
3. Turn on your jamming pod by pressing **[J]**.
4. Gain a tally on the missile and keep it on your 3/9 line. If you can't pick up a tally on the missile, keep the shooter aircraft on the beam using the Extended FOV, Padlock or Virtual Cockpit views.

- After establishing the missile or shooter aircraft on your 3/9 line, do a series of loaded pulls up and down in the vertical plane as shown in Figure 30-6. These pulls in the vertical with the missile on the beam may force a larger miss distance on the missile. The goal is to make the miss distance greater than the missile warhead's lethal radius.

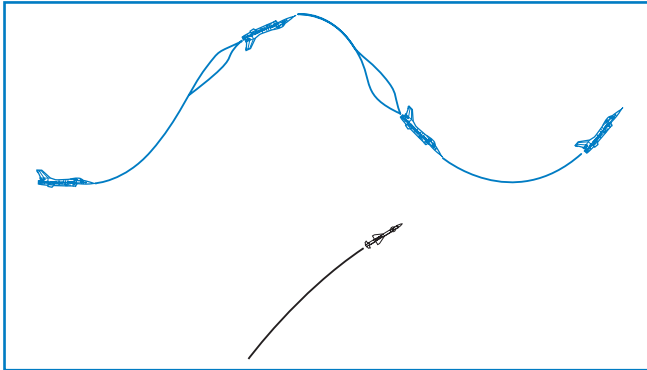

Figure 30-6

Again, these procedures are not magic. They will, however, give you the best chance of surviving an enemy missile attack.

MISSION 31: HEAD-ON BFM

Head-on BFM is more complicated and requires more maneuvering than either offensive or defensive BFM. As you approach an enemy fighter head-on, you have several options, in sharp contrast to the narrow choices you have on defense. On defense, it is simply turn hard into the bandit or die. Even when you start behind the bandit, your options are limited to flying the control position and shooting whenever you can. When you pass a fighter head-on, you have the option to separate, stay in the fight, or stay and try to kill the bandit. In fact, the biggest decision you must make when passing a bandit head-on is whether you should get anchored in a turning fight. A lot of time and energy will be expended if you enter a turning fight with a bandit that starts from a head-on pass. Energy is, of course, what you need to maneuver and time can be used against you if a third bandit finds your fight. If you take too much time, you may be winning the fight you started with one bandit but losing a fight with a second bandit you don't see. There are many reasons to try to separate from a fight—and just as many to stay and try to kill the bandit. This training mission covers what to do when you decide to turn and fight.

OPTIONS AT THE PASS

As you approach a bandit head-on, focus on ending the fight as quickly as possible. Remember, the bandit is probably thinking the same way so stay craniums up. As you approach the bandit from head-on, shoot a heat missile if you can and don't forget your gun. In most head-on passes, you will have to sacrifice BFM to shoot the gun, so it is not advisable to try to line up for a gunshot all the time. If you are committed to separate out of the fight, however, it is a very good idea to try for a head-on gunshot before getting out of Dodge.



Again, keep in mind that the bandit may be lining up for a gun attack on you. Even if he is not, head-on gunshots are dangerous because of the high collision potential. Your options as you pass the bandit are (1) you can go straight up in the vertical, (2) you can turn nose low, or (3) you can turn level. You can do a few other things like pitch back or split S, but these maneuvers are not optimum maneuvers for getting around on the bandit.

Before we discuss your options in detail, remember an axiom taught to me by an old fighter pilot named "Shooter" Summers: Head-on fights are lost and not won. This means that head-on fights require a lot of maneuvering, and the odds that one of the players will make a mistake are high. The biggest mistake made during head-on BFM is losing sight of the bandit. Since you can't fight what you can't see, this is a sure way to get your knickers ripped. The absolute best BFM move is no good if you lose sight of the bandit halfway through the maneuver. While losing sight is a real problem in the real F-16, the Padlock view should help you keep a tally in *Falcon 4.0* unless the bandit moves into your blind spot. The main way to lose sight in the game is through GLOC (Gravity-Induced Loss of Consciousness). If GLOC is enabled in the Simulation setup, you must be careful not to pull too hard for too long and lose sight of the bandit. Other head-on BFM mistakes are insufficient G, poor airspeed control, bad lift vector control, not lead turning or trying to BFM an F-15 Eagle against an F-16 (which is especially stupid).

Let's talk about each (good) option on a head-on pass.

THE SLICE

The quickest way to get your nose around on the bandit is by initiating a lead turn slice into the bandit. To perform this maneuver, when the line of sight rate of the bandit starts to increase, start an immediate 8 G lead turn into the bandit with your nose about 10° below the horizon. How do you know when the line of sight rate is increasing? Just think of a car going the opposite direction on the freeway. You see the car coming for a long way, but it does not move very much on your windshield. As it gets closer, though, it starts to drift to the left. When it is about to go by you, it moves very rapidly off your windshield to your side window. When the movement of the target starts to accelerate, that's when you start to turn.

By pulling around with your nose low, you gain the use of gravity, which will preserve your airspeed and increase your effective turn rate (remember radial G). The slice should be one of the Falcon pilot's favorite moves. The reason is simple. Since the F-16 can outturn anything in the sky, a big lead turn, executed nose low, will intimidate the bandit. This turn is intimidating because after completing it, you will gain angles on the bandit and still have plenty of energy for the next turn. The disadvantage of the slice is that it is a high G, nose-low maneuver that places the bandit at deep six and out of sight momentarily.

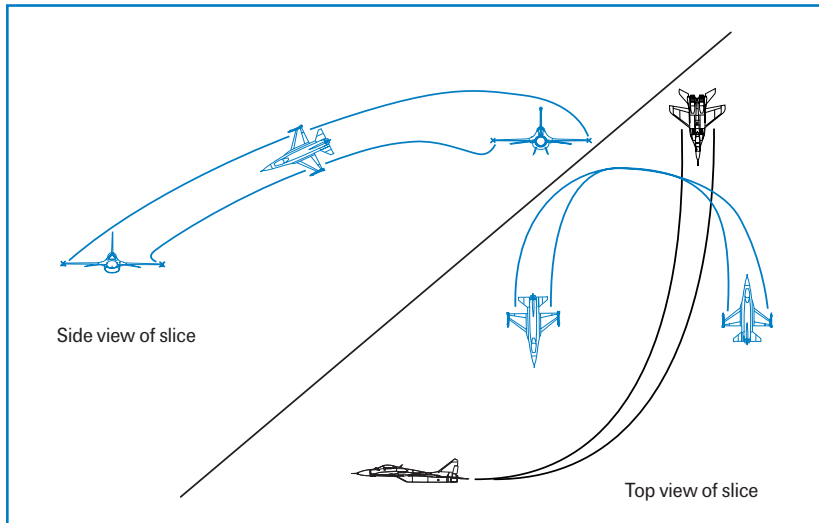

Figure 31-1

Figure 31-1 shows how this maneuver looks.

THE LEVEL TURN

Another good option at the pass is a level turn into the bandit. This option does not get your nose around as fast as the slice, but its big advantage is that at low altitude you won't double-dribble yourself off the ground. In addition to being safer at low altitude, it is far easier to stay oriented to the horizon. The level turn is executed in the same way as the slice except that you drag your nose straight across the horizon. Because you don't get the same added boost from gravity with a level turn that you do from a slice, you will turn slower and lose more energy in this turn.

THE VERTICAL FIGHT

The last move is a straight pull up into the vertical. This move is only advised in a few special cases. The vertical fight is used after a head-on BFM engagement is mature and you have a significant energy advantage over your opponent. As a general rule, don't go into the vertical on the first move. The reasons for this are threefold:

- ✦ Your opponent will gain angles on you with a nose-low turn.
- ✦ You present a very good IR target against the blue sky for a heat missile shot.
- ✦ It is very difficult to fly a flawless vertical fight when starting at equal energy as the bandit.

If you do decide to go in the vertical on your first head-on pass, here is how you do it. As you pass the bandit, start a wings-level pull at 550 knots. This is not corner velocity, but it doesn't matter. As you start your 7 G pull, you will bleed off knots like sweat off a pig. Figure 31-2 shows this initial move in the vertical and how much altitude you will gain on the bandit by pulling straight up rather than in the oblique.

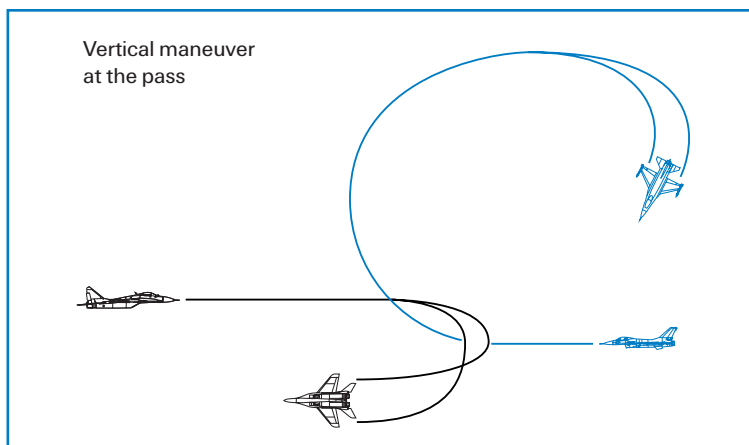

Figure 31-2

As you get to the pure vertical (straight up), pick up the bandit and pirouette to rotate your lift vector right on him. When your lift vector is on him, pull down. If he sees you, he will pull up into you. At this point, you will be on the receiving end of the nose high to nose low lead turns. In this situation, counter the lead turn by starting a lead turn of your own. After you counter the lead turn, continue around in a level turn to put your lift vector on the bandit. The other option is to continue the vertical fight. If you go up again, do not wait until you get to 550 knots. When you have 300 knots and are passing the bandit, go up. If you delay your pull up, the bandit will make angles on you. Once you get to the pure vertical, repeat the pirouette and pull. You know you are winning this fight when the bandit no longer pulls his nose up into you. If you see that he can't come up, he is out of energy. You now own the turning room above the bandit and can use it to convert on him.

The time to use the vertical fight normally is after you pass the bandit the third time using one of the first two options previously discussed. If you can tell he is slow, you may want to take it into the vertical. How do you know a bandit is slow? He can't rate his nose. Remember that if you are committed to going vertical, roll wings level and make your initial pull straight up, then roll to find the bandit and pull for him. Do not go into the oblique. You will give the bandit turning room. An old fighter pilot saying from the Vietnam era states: "You meet a better class of people in the vertical." This is still true in many ways today.

ONE-CIRCLE AND TWO-CIRCLE FIGHTS

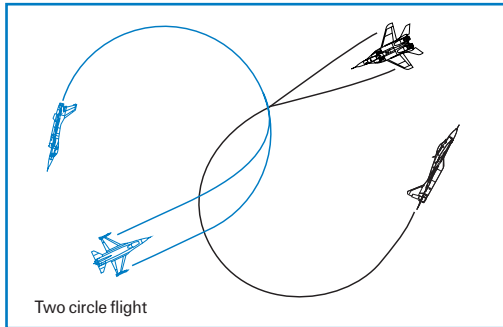

Figure 31-3

The options that we discussed at the pass can result in either a one-circle or two-circle fight. If both fighters start a lead turn, then the fight will go two-circle as shown in Figure 31-3, which means that two distinct turn circles are created.

If one of the pilots turns away, then the fight goes one-circle, as shown in Figure 31-4.

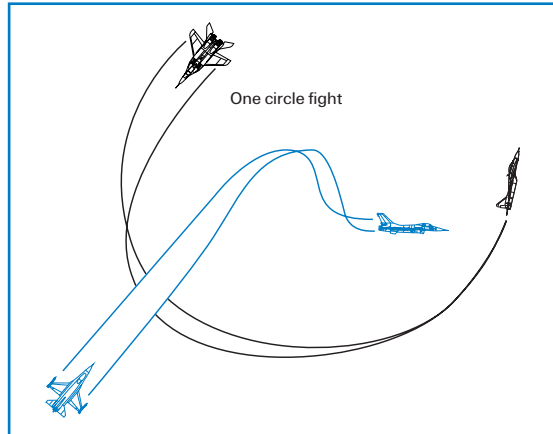

Figure 31-4

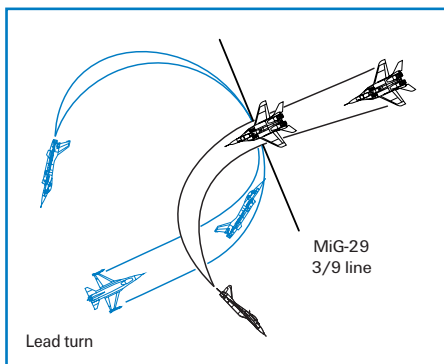

Figure 31-5

Keep in mind that either you or the bandit can force a one- or two-circle fight. The Falcon pilot should understand the characteristics of both of these fights. Most head-on passes result in two-circle fights. The reason for this is straightforward. Usually, fighters lead turn into each other to use the turning room available in an attempt to reduce angle-off. A lead turn is a turn into the bandit prior to actually passing the bandit, as shown in Figure 31-5.

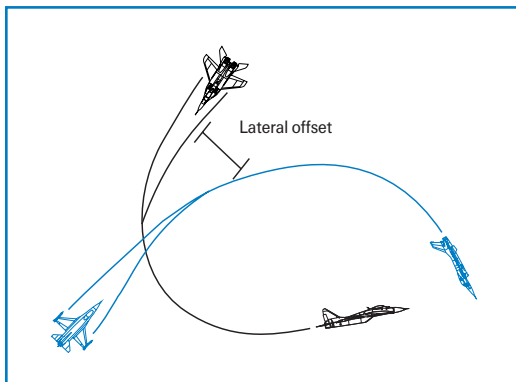

Figure 31-6

If you are offset from the bandit and turn away, you are not using the turning room available and, worse yet, you are letting the bandit use it. Figure 31-6 illustrates why turning away from the bandit will cause you big problems.

Two-circle fights have another advantage for an aircraft with a high turn rate and an all-aspect heat missile: you may be able to get your nose around fast enough to get a shot at the bandit. A one-circle fight is usually too tight for a heat missile shot after the pass. In fact, that is the principal reason for taking a fight one-circle. If you are in a fight without an all-aspect heat missile against a fighter who can shoot you with an all-aspect heater, try to jam the bandit's missile by going one circle. Another time to take the fight one circle is when you are very low on energy compared to your opponent. In this case, try to jam him and keep the fight tight by going one circle.

A last word about one-circle and two-circle fights: once you have started your turn, don't reverse it. In other words, if you want to go two circle but the bandit turns away from you, just keep turning. You will give up far too many angles by reversing your turn.

TRAINING MISSION OVERVIEW

In this mission, you will practice head-on BFM against an Su-27.

INITIAL CONDITIONS

- ✦ Airspeed: 400 knots
- ✦ Altitude: 15,000 MSL
- ✦ Throttle Setting: Mil
- ✦ Configuration: Gear up and 6 AIM-9s

TRAINING MISSION DESCRIPTION

This mission starts from a head-on position. When the simulation starts, the Su-27 will pass you close aboard and then start a turning fight. In this training mission, you can practice a head-on gun shot or any of the head-on BFM options that we discussed. The optimum maneuver at the pass is the slice.

Follow these procedures to execute an effective slice at the pass:

1. Load training mission "31 Head-on BFM" from Tactical Engagement.
2. Ensure that you are 400–450 knots.
3. Use the TWS radar mode to track the bandit so you will not spike him. Do not use ACM or go to STT.
4. When the bandit's line of sight rate starts to increase (remember the car example above), roll into 120° of bank and start a max G pull into the bandit as shown in Figure 31-7.
5. Keep your nose about 10° nose low and go full afterburner. Be careful not to let the airspeed get to 440 knots. If it does, come out of afterburner immediately.
6. Keep your lift vector right on the bandit and try to stay at corner airspeed (331–440 knots).
7. Place the radar in vertical scan to get a lock as soon as possible.
8. Any time you enter a missile WEZ, shoot.
9. Don't forget that if the bandit is getting his nose on you, he may be in a position to shoot you—so watch out.

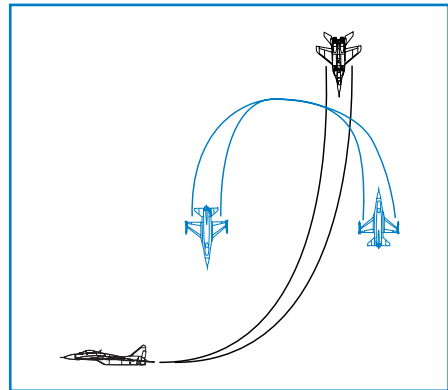

Figure 31-7

Success in head-on fights take time to learn, so be patient. The pilot who makes the fewest mistakes will win the fight. The two biggest mistakes you can make in head-on BFM are letting your airspeed get away from you and not shooting when you get a chance.

PART 2: **MAIN MODULES**

CHAPTER 9: INSTANT ACTION

CHAPTER 10: DOGFIGHT

CHAPTER 11: TACTICAL ENGAGEMENT

CHAPTER 12: CAMPAIGN

CHAPTER 13: LOGBOOK

CHAPTER 14: ACMI

CHAPTER 15: TACTICAL REFERENCE

CHAPTER 16: SETUP

CHAPTER

9



INSTANT ACTION

Instant Action is the place to be when you want to start flying and fighting right away. To get into Instant Action, click the Instant Action menu item on the left of the screen. The Instant Action screen has three sections: the Options area, the Map and Sierra Hotel. Once you've set your options, click the Fly icon at the bottom right of the screen to take off.



INSTANT ACTION OPTIONS

Use the Instant Action options area to customize three areas of your experience. You can also use the main Setup options to further customize the game.



MISSION

The Mission option allows you to choose between a primarily air-to-air mission and a ground attack mission. Choose “Fighter Sweep” for a chance to shoot down lots of air threats. Choose “Moving Mud” for more air-to-ground targets. Your mission choice will affect your weapons loadout.

WAVE

This setting—either Recruit, Cadet, Rookie, Veteran or Ace—determines the enemy difficulty level. The higher the level of enemy difficulty, the smarter, faster and more deadly the enemy will be. This setting applies to both air threats and ground threats. You will encounter more cargo planes and fewer fighter planes at the easier settings and correspondingly more fighters and fewer lightly armed craft at the higher settings.

AIR DEFENSES

Since most countries don’t like hostile aircraft flying over their airspace, they prepare ground-based surprises for you. Instant Action has two forms of surface-to-air threats: SAMs (Surface-to-Air Missiles) and AAA (Anti-Aircraft Artillery).

THE MAP

You can select any area in the Korean peninsula for your Instant Action battle. Click inside the gray square and drag it anywhere within the map. This will position your F-16 in the corresponding location at the start of the battle. You can also set the start time by clicking on the clock and then using the arrow icons. Change your start time to fly during the day or night.

ENDING YOUR MISSION

You fly and fight in Instant Action until you decide to quit, land, eject or get shot down. The enemies are unending and relentless. If you are shot down, the Instant Action mission will automatically end. You can also end at any time by pressing **[Esc]**.

When an Instant Action mission ends, you'll return to the Instant Action main screen. If you're fortunate enough to score enough points to put you in Sierra Hotel (the best of the best), your name will be added to the list.



Next, you'll see the Debriefing window. The events list displays the outcomes of all the weapons you and the enemy fired. You'll also see notations of any times you crashed.

Next to the events list is the score list. Your score is determined by your kills of aircraft and ground targets, multiplied by your realism setting. Points are deducted from your score for expending munitions (except guns, which are free). The more missiles and bombs you use that do not hit targets, the lower your score—and on a bad mission, you can even have a negative score. The top right-hand box lists all the enemy targets that you destroyed. Underneath is a list of all the ordnance that you used.

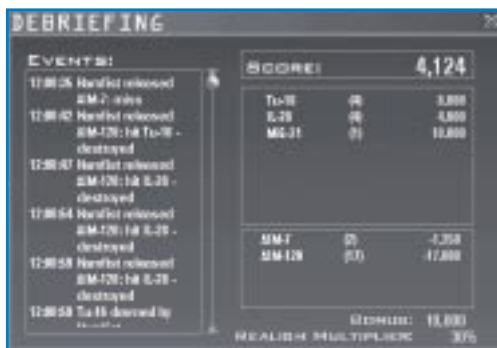

CHAPTER

10



DOGFIGHT

The Dogfight module provides you with head-to-head action against other aircraft. In it, up to four teams, in any combination of human and AI (Artificial Intelligence, or computer-controlled) pilots, can battle in the skies. Enter the Dogfight module by clicking Dogfight in the main menu.

STARTING A DOGFIGHT

1. If you are playing a Dogfight game by yourself, click on the Saved tab.
2. Click one of the Dogfight setups below (Furball, Match Play or Team Furball) or choose a setup you've previously created. Read below for more information.
3. Click the Commit button in the lower right to continue.

If you want to play in a multiplayer Dogfight game, see **The Communications Handbook** for more information.



COMMIT BUTTON

DOGFIGHT SETUP

There are three Dogfight setups: Furball, Team Furball and Match Play. Under each, all of the participating teams and their aircraft are displayed. Each plane icon is identified by a flight name, with the number and type of aircraft underneath. Click the "+" symbol to see each plane in the flight with the pilot's callsign and Ace Factor.



FURBALL

In Furball, it's you against everyone else. You rack up your score by the number of kills you make. You get a point for each kill you make—but you lose a point each time you crash into the ground or eject when you are not damaged. When you set up a furball, set the Points slider to the number of points required to win. Once any player earns this number of points, he is declared the winner of the furball. If the slider is set to Unlimited (the far right), the furball ends only when all the participants quit.

When you start a furball, all aircraft begin the fight spaced apart near the starting location. When you are killed or eject, you are “regenerated” into the dogfight and placed near the action with a new load of weapons. This occurs until either the point limit is reached or you press **[Esc]** and then **[E]** to end the dogfight.

Once any player, including any AI pilot, reaches the number of points required to win, the furball is over and all players return to the Dogfight screen. The events list will describe all the action, along with all the scores. The scores show each pilot's name, score, the number of kills and the number of deaths.

Furball Setup

To add AI pilots to a furball, click the Add Aircraft icon to open the Add Flight dialog box. Choose the type of aircraft, the pilot's skill level and markings (color scheme) for the new flight. You can also add aircraft by right-clicking on a blank area of the Pilots list to display a pop-up menu with options for markings, skill level and aircraft type. You can also change the aircraft type for a flight by right-clicking directly on the plane icon. Note that in Furball games, each flight has only one aircraft.



To delete an AI pilot, right-click on the “+” to the left of the aircraft and choose Delete from the menu.

If you are in a Furball game, you can change your plane's color scheme (paint job). Click on the plane icon and then click one of the color schemes to the right. Your choices are Crimson, Shark, USA and Tiger. Color schemes do not affect gameplay in Furball since there are no teams.

TEAM FURBALL

In Team Furball, you play in teams—but your goal is still to reach the point limit the game’s host set using the slider. However, your team wins when the cumulative number of kills made by your team equals the point limit. In other words, the first team whose combined points equal the limit wins. If you set the slider to Unlimited, then the game isn’t over until all players quit. You get a point for each kill you make—but you lose a point each time you crash into the ground or eject when you are not damaged. In addition, your team loses a point each time you kill a teammate.

When you start in Team Furball, you and your teammates begin the fight in the same quadrant. When you die or eject in Team Furball, you are regenerated just as in Furball.

Once a team reaches the required number of points, the furball is over and you return to the Dogfight screen. You’ll see the events list and scores, including a team score.

MATCH PLAY

A Match Play dogfight consists of one or more engagements, each with identical starting conditions. When you start in Match Play, you and your teammates begin the fight in the same quadrant. To win a match, your team must win the number of sets indicated by the Points slider. If it is set to Unlimited, the match isn’t over until all players decide to quit.

Every time one team kills all the aircraft of the opposing teams, that team scores a point and the teams are reset to their starting positions and weapons loadouts for a new fight. If you are killed in the middle of a fight, you cannot reenter until the new engagement begins. Once a Match Play dogfight begins, no new pilots can join in (unlike in Furball or Team Furball). If you exit the simulation, you cannot rejoin.

After a match is over, everyone returns to the Dogfight screen and the events list is displayed.

Team Furball and Match Play Setup

In Team Furball and Match Play, the left side of the screen is divided into four quadrants, each quadrant representing a team. The quadrants also represent the starting location for each team. Click the Join button corresponding to the team you want to fly for. You can also right-click in the team’s quadrant and select “Join” from the pop-up menu.

Click the “+” next to the plane icon for your flight to display your callsign and Ace Factor. The flight callsign is distinct from your personal callsign.





If you want to add AI pilots to a particular team, click the Add Aircraft icon for that team to open the Add Flight dialog box. Choose the type of aircraft and pilot's skill level for the new flight. If a plane icon is selected, clicking the Add Aircraft icon will add a new aircraft to that flight. You can also add aircraft by right-clicking in the team quadrant to display a pop-up menu containing skill levels and aircraft types. Right-clicking on a flight will add an aircraft to that flight. You can also change an aircraft type or skill level by right-clicking directly on the plane icon.

To delete an AI pilot, click on the "+" to the left of the aircraft, click on the pilot skill level and then click on the Delete button.

THE MAP

Use the map area to select the location of your dogfight. Simply drag the gray square anywhere on the map of the Korean peninsula. You can also select a starting time for the battle. Click the hours, minutes or second field of the 24-hour clock and change the time with the forward and back arrows. (If you set the clock to nighttime, you will have to rely almost entirely on your instruments.)

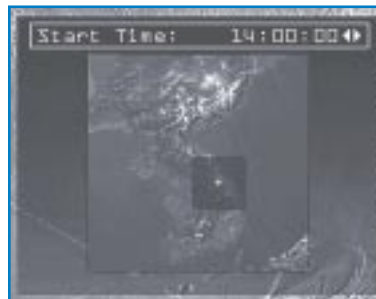

GAME OPTIONS

Select from these options to configure your Dogfight game. Once the Dogfight game is started, these options cannot be changed.



Game

Choose the type of Dogfight you wish to play: Furball, Team Furball or Match Play.

Rear-Aspect IR Missiles

Select the number of rear-aspect IR (Infrared) missiles each aircraft starts with. Rear-aspect IR missiles include the AIM-9P Sidewinder.

All-Aspect IR Missiles

Select the number of all-aspect IR (Infrared) missiles each aircraft starts with. All-aspect IR missiles include the AIM-9M Sidewinder.

Radar Missiles

Select the number of radar-guided missiles each aircraft starts with. Radar missiles include the AIM-120 AMRAAM.

Unlimited Guns

Select unlimited guns if you don't want to worry about running out of cannon rounds. Otherwise, you are limited to 510 rounds for your M61A1 Vulcan cannon, and enemy AI planes are limited to their normal cannon load.

ECM

Select ECM if you want everyone in the Dogfight game equipped with an ECM pod for countermeasures.

Range

The range slider determines how far each group of aircraft is from the starting location. The fighters will start toward a central point. Choose a range from 5 to 60 nm apart.

Altitude

The altitude slider determines the starting altitude for the dogfight. Choose an altitude between 2,000 and 60,000 feet.

Points

The Points slider determines the number of points needed to win. Choose a number from one to unlimited.

SAVING A DOGFIGHT SETUP

Once you've created a Dogfight game, you can save the entire setup. Click Save on the left menu and name the setup in the Save dialog box.

FLYING THE DOGFIGHT

To start the dogfight, click the Fly icon in the lower right-hand corner.

EXITING THE DOGFIGHT

Exit a dogfight at any time by pressing **[Esc]** and then **[E]** for "End Mission." In Match Play, you cannot join again until the current match is complete.

REVIEWING YOUR DOGFIGHT

You can turn on your flight recorder during a dogfight by pressing **[F]**. When you exit the dogfight, click ACMI in the main menu to review your dogfight.

CHAPTER

11



**TACTICAL
ENGAGEMENT**

“Tactical engagement” is the term used by Air Force personnel to describe any planned encounter with the enemy. When actual missions are created, Air Force personnel rely on tools similar to ones in *Falcon 4.0*’s Tactical Engagement editor.

This chapter walks you through the Tactical Engagement editor and shows you how to create missions that closely parallel actual military procedure and structure. After you finish reading this chapter, you will be able to create both simple missions to test an idea and lengthy mini-campaigns involving numerous warring nations, ground forces and sorties so thick you can cut ‘em with a knife.

Remember: you can always click on the Help icon at the bottom of the screen for information about Tactical Engagement.

OPENING SCREEN

Tactical Engagement lets you fly training missions, create new engagements, and edit or join existing ones. The opening screen is divided into three areas:



Load Mission allows you to choose the mission or engagement you’d like to fly, edit an engagement or join one online. You can choose a training mission, a new or saved engagement, or joining an online engagement. This chapter shows you how to create new engagements and edit the missions that appear under the Saved tab. (Note: For information on hosting and joining online games, see the **Communications Handbook**.)

Theater Map appears only after you have selected a mission. This map displays the balance of forces in the currently selected engagement. Each team involved in the engagement is represented by a different color on the Theater Map. The different teams that make up the engagement are listed to the left of the Theater Map. If you are creating a new engagement, the Theater Map is where you’ll choose the team you’d like to join.



Mission Description appears only after you have selected a mission. This overview provides a quick synopsis of the engagement or mission.

TRAINING MISSIONS

Falcon 4.0 includes 31 training missions (**Part 1: Training Missions**) created by Pete “Boomer” Bonanni, an F-16 instructor pilot. To jump into a training mission, simply select the Training tab and then the mission you’d like to fly. Review the objectives for this training mission in the Mission Description area before clicking on the Commit button in the lower right corner. The Mission Schedule window will appear. Start the training mission by clicking on the Fly button in the lower right corner. For more information, see **Chapter 1: Learning How to Fly**.



PLAYING A TACTICAL ENGAGEMENT

It’s as much fun to play a tactical engagement as to create one. Test your skills by downloading missions that other *Falcon 4.0* pilots have created from www.falcon4.com.

If you are playing a tactical engagement (rather than creating or editing one), you will not be able to access all of the Tactical Engagement editor tools described below.

When playing a mission, you can create and plan mission packages, as well as issue orders to ground units—but you cannot add new units or squadrons, or drag units to a new location. In addition, Teams and Victory Conditions can only be edited when building a mission.

You may also notice many similarities to playing in the Campaign. In the Campaign, a large planning staff is working tirelessly behind the scenes to determine the most valuable targets and to frag out orders for all the aircraft and ground units on your team. In Tactical Engagement, you are the planning staff as well as a pilot. (Actually, the person who built the mission may have planned out some missions and orders for you already.) In the Campaign, you can only fly missions assigned to your chosen squadron. In Tactical Engagement, you can fly any F-16 mission—plus, if you don’t see any you like, you can plan a new mission (as long as aircraft are available). Finally, in the Campaign, since victory depends as much on destroying the enemies’ will to fight as on achieving specific military objectives, there is no concrete list of victory conditions. In Tactical Engagement, the military objectives you must achieve to succeed are clearly spelled out in the victory conditions and are assigned a point value.

LOADING A TACTICAL ENGAGEMENT

Loading a tactical engagement involves a few simple clicks and then you're on your way to participating in a new mini-campaign or sortie. To load a tactical engagement, follow these steps:

1. Click on Tactical Engagement in the main menu.
2. In the opening screen, click on the Saved tab.
3. Click on the filename for the engagement you'd like to play.

The right side of the screen displays the Theater Map and the Mission Description. Click on the team you'd like to join in the Theater Map, then review the mission below. When you finish, click on the Commit icon in the bottom right corner.

The Mission Schedule window will open. Click on the mission you'd like to fly in the Mission Schedule list, review the flight plan and briefing, and then click on the Fly icon in the lower right corner to take off!



If you forget to stop the clock while you're dilly-dallying around looking at the briefing or fiddling with loadouts, the flight you want to fly may take off without you. You can still jump into the mission even though it has departed simply by clicking on the Fly icon. *Falcon 4.0* will drop you into the mission wherever the aircraft is located, provided that the flight has not reached its last steerpoint before the target (called the IP or Initial Point).

- Click on the P'yongsan Nuclear Plant, which looks like  and is located near the border. (To find the P'yongsan nuclear plant on the map, turn names on or hold your mouse cursor over the icon until a map label appears.) After clicking on the nuclear plant icon, the Add Package window will appear.



- Lock the takeoff time by clicking on the padlock icon until it is green and in the locked position.



- Click on the New button and the Add Flight window will appear.
- Review the defaults that *Falcon 4.0* automatically computes for the mission. Ensure that the Aircraft type is "F-16C" and that the Role type is "Strike." Click on the OK button to close the Add Flight window. Your flight will appear in the Add Package window.



The takeoff time appears in the package window. The mission planner automatically computes steerpoints to the target, and you will see the flight plan on the map.

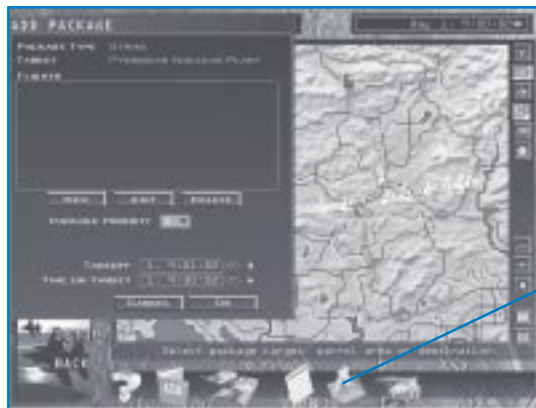

FLIGHT PLAN

8. Click on the OK button in the Add Package window.
9. Click on the Flight Plan icon at the bottom of the screen.
10. Cycle through the steerpoints by clicking on the right arrow next to STPT (Steerpoint) until you see TGT (Target). Click on the Assign button that appears at the bottom of the window.
11. When you click the Assign button, the Target List window will appear. Scroll through all the targets in the vicinity of your steerpoint. Expand the target list for the nuclear power plant by clicking on the "+" sign. Select the specific target that you want destroyed at the nuclear power plant site, and its name will turn green.

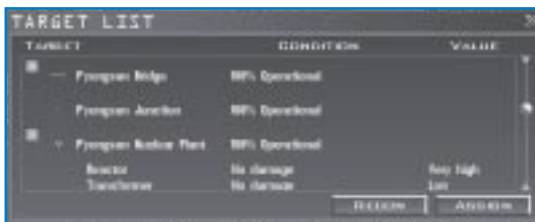

- Click the Recon button to see a black-and-white satellite image of the target. Verify that it is the target you want. Then close the Recon window by clicking on the "X" in the upper right-hand corner.



- Click the Assign button at the bottom of the Target List window to assign that target to your package. Close the Target List window.
- Verify that the correct target is shown in the Flight Plan window. When you finish, close the Flight Plan window.



- Click on the Briefing icon at the bottom of the screen. This is automatically filled in after you select a flight plan and target. Scroll through the briefing to see your mission objectives and munitions for your wingmen. Munitions for the mission are automatically configured. Close the Briefing window when you're finished reading.
- If the Add Package button is green, click on it again to deselect it.



ADDING OPPOSITION

A bomb run is challenging, but it's even more adventurous when you have two MiGs barreling down on you from above. To add an intercept mission to your new strike sortie, follow the steps listed below:

1. Click the Fit Flight Plan button so you can see the entire route from takeoff to target.
2. Turn on the icons for the fighter planes by right-clicking on the map and selecting Air Units – Fighter from the pop-up menu.
3. Click on the minutes field of the clock above the map and click the right arrow to advance the clock. As you advance the clock, the icon for your F-16 flight will appear and begin moving along the flight plan. Keep advancing time until the your flight's icon appears halfway between your airbase and the target on the route.

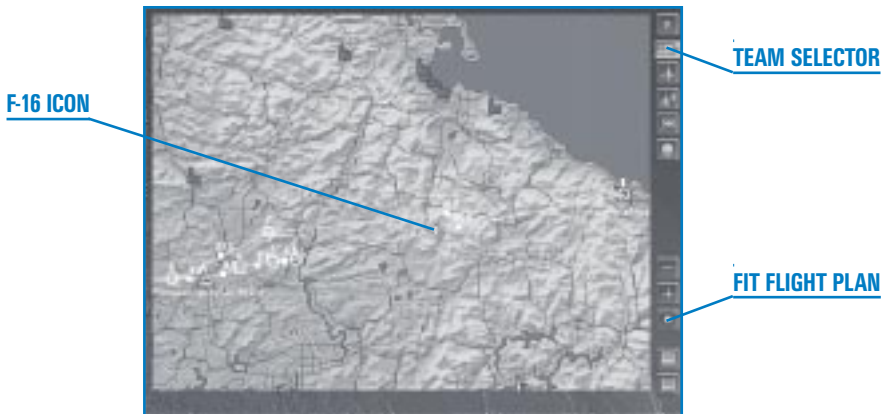

Now you're going to add a package to intercept your flight.

4. Change teams by clicking on the Team Selector button in the top right. The default team is the USA in blue. Click on the Team Selector button to select North Korea (the other flag).
5. Turn on map labels by right-clicking on the map and selecting Names.
6. Zoom in on your blue F-16 icon by clicking the "+" button until the map labels are readable.

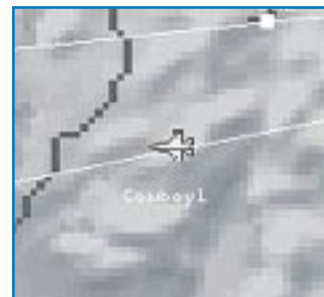

- Click on the Add Flight icon. Then click on the F-16 icon for your flight, which appears along the route.
- The Add Flight window will pop up again. Change the aircraft to a MiG-29 by selecting it from the Aircraft drop-down list.



- Check to make sure that Role is set to Intercept. The target will change automatically to the closest aircraft that can be intercepted. Check that the target is your flight name (as seen on the map).

Not every aircraft type can fly every mission. If you choose an attack aircraft, such as an Su-25, Intercept will not be available in the Role drop-down list.

- Click on the OK button in the Add Flight window.



- Click on the Flight Plan icon at the bottom. Cycle through the steerpoints until you see TGT. Then confirm that the target matches your flight's name. Click the "X" button in the upper right-hand corner when you're finished.



ADDING VICTORY CONDITIONS

Now, it's time to add some victory conditions to the mission you've built. Victory conditions establish what a team needs to do in order to complete its mission successfully.

1. On the left side of the screen, click on Victory Conditions.
2. Zoom in on your flight's target (which is the P'yongsan nuclear power plant) by clicking the "+" button. Drag the map to center the target. Right-click on the icon for the nuclear power plant.
3. Select "Add Victory Condition" from the right-click menu. The victory condition will appear in the window below.
4. Make sure that the victory condition is assigned to your team, which is the USA. If not, select the correct team from the drop-down list.



5. The victory condition is automatically configured for destroy or degrade. Select "Destroy" from the drop-down list. After the Target List window appears, click on the "+" sign to expand the target list. Click on the reactor at the nuclear power plant site that you assigned yourself earlier. It will highlight in green.

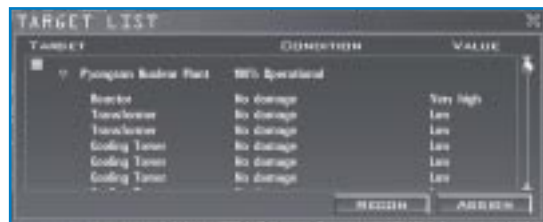

- Click on the Assign button and then close the Target List window. You will see the specific subtarget following the main target in the list.

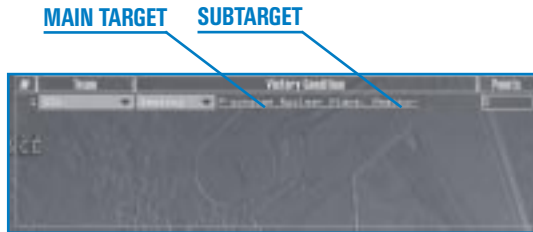

- Right-click on the map and select Show Victory Conditions from the pop-up menu. You will see a blue diamond around the target icon in your team color. You will also see "Victory Condition 1" underneath the name of the target.



- Now, we're going to assign a point value for successfully destroying the target. Click in the Points field, type a new point value of 1,000 and then press **Enter**.

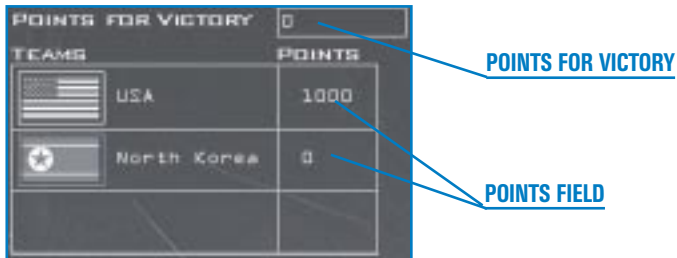

- Now let's set the victory conditions for the other team. Click the New button to create a new victory condition.
- Change the team assignment to North Korea.



- Click the underlined word "Assign" to the right. Move your cursor over your flight's icon (the blue F-16) and hold it there until you see your flight's name pop up. Now click on your flight's icon to select your flight as the new target for the other team's victory condition.

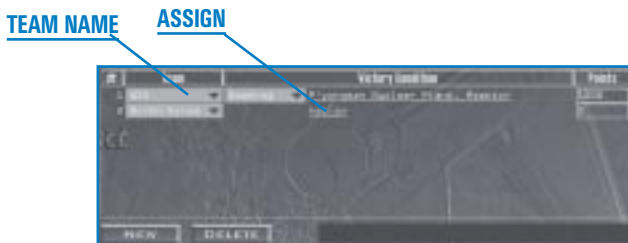

- Make sure that the Victory type is set to Intercept and that the name of your flight appears under Victory Condition.



- To set the minimum number of destroyed aircraft required to complete this intercept mission, select "1."



- Enter the number of points for meeting the Victory Condition as 1,000 and press **Enter**.



15. Click on Points for Victory at the top of the Victory Condition window and type in the required points for any team to win. Type in 1,000 so that either team can win the mission.
16. Under Mission Type at the top of the window, select Sortie (not Engagement).
17. Change the Start Time clock to "1, 8:57:00" (Day 1, 8:57 AM).



18. Set the Time Limit for the mission to "1, 12:00:00."
19. Set the Tactical Engagement clock back to "1, 8:57:00." Otherwise, the mission may start without you when you load it.
20. To save your brand-new tactical engagement, click on Save on the left side of the screen. Give the mission a name in the text field at the bottom of the dialog box. Click the Save button to save your tactical engagement.

Whew, you've completed creating your first tactical engagement... but, now it's time to fly it!

LOADING AND PLAYING THE MISSION

1. At the left side of the screen, click on Back to return to the Load Engagement window.
2. Click the Saved tab. Your new tactical engagement should appear. Click on the filename to select it.





3. Choose the team you want to fly (USA) in the Theater Map area by clicking on it.
4. Click on the Commit button in the lower right corner.
5. Click the mission you want from the Mission Schedule list.
6. Click a plane icon below to place yourself in that plane. “1” is the lead aircraft, and “2” is the wingman.
7. Jump into the aircraft by clicking on the Fly button and you’re off! Keep an eye out for MiG-29s as you approach the nuclear power plant because they’re waiting for you!

Note that you can only fly F-16s. You cannot fly any missions in any other aircraft. You cannot jump into the intercept mission since it is assigned to a MiG-29 flight. If the intercept used F-16s, however, you could choose that mission and fly in the aircraft.

BUILDING TACTICAL ENGAGEMENTS

The Tactical Engagement editor gives you a lot of power to create missions, but with power comes responsibility. Since there is no staff in Tactical Engagement to continuously plan missions in pursuit of the engagement objectives, it is up to you, the builder, and the players flying an engagement to plan all missions. If you are making a mission to be played solo, you should plan the enemy team’s air missions for the full duration of the engagement. Otherwise, the player can evade your toughest defenses simply by waiting for the enemy aircraft to land. It is also your responsibility as the builder to ensure that a mission can be won by setting up the appropriate victory conditions and to make the mission fair, challenging and fun.

It is also worth noting some things you can’t do in the Tactical Engagement editor. You can’t force the player to fly a particular route or use a particular weapons loadout. This means your opposing air defenses should be comprehensive enough to cover alternate approaches to the targets you assign. You can’t place ADA (Air Defense Artillery) systems or vehicles individually. Ground units will deploy around their battalion’s location according to the terrain, their training doctrine and their mission orders. Finally, you cannot add ships to an engagement, although naval aircraft and marine units can be based on land.

TACTICAL ENGAGEMENT TERMINOLOGY

Before you begin editing, it is important to know the terms used in battle and in this chapter.

Flight	A group of from one to four aircraft.
Task/Role	The specific task or role assigned to a flight. See the section “Aircraft Mission Roles” in this chapter for details.
Package	A group of flights that are flying together to accomplish a specific tactical objective. Blowing up a bridge, for example, is an example of a tactical

objective. To complete this objective, strike, SEAD and escort flights may be necessary. All of these flights would be part of the same package.

Mission	The general objective or reason for a package.
Sortie	A single mission from takeoff to landing. In <i>Falcon 4.0</i> , sorties are short engagements centered around one mission or tactical objective.
Engagement	The actual fight with the enemy. In <i>Falcon 4.0</i> , this is a long-term mini-campaign that includes packages with multiple tactical objectives.
Victory Condition	A specific military objective.
Victory Points	Points awarded for achieving victory conditions.
Team	A combatant in a tactical engagement.

THE TACTICAL ENGAGEMENT EDITOR

At the Tactical Engagement opening screen, click on the Saved tab. Then click on New to create a new tactical engagement. The Tactical Engagement editor will load. *Falcon 4.0*'s Tactical Engagement editor takes you beyond traditional mission editors in other flight simulations by allowing you to create mini-campaigns. These mini-campaigns, called "engagements" in *Falcon 4.0*, can include ground and air movements with numerous objectives. If you'd rather put together a simple mission, the Tactical Engagement editor can also create these simpler "sorties."





The Tactical Engagement editor has the following tools listed on the left side of the screen:

Mission Builder	This is the primary tool for setting up the forces involved in an engagement and for planning missions and flights.
Teams	You can divide the Korean peninsula by teams (up to 7). You can also set skill levels for each team.
Victory Conditions	You can assign victory conditions and points awarded for achieving specific military objectives and the number of points needed to win an engagement. The mission start time and time limit are also set here.
Save	Press this button to save your current tactical engagement.
Restore	Press this button to restore the existing tactical engagement to its last saved state.

More tools are provided along the bottom of the Tactical Engagement screen: ATO, OOB, Briefing, Flight Plan and Munitions.

MISSION BUILDER

New engagements automatically include two teams: USA and North Korea. If you're happy with these default teams, then you can begin building missions immediately. Otherwise, click on the Teams button on the left side of the screen and read the section "Teams" later in this chapter.

Start your Tactical Engagement editing by viewing different military assets on the Mission Builder map. You can view airfields, ground forces, packages and more. Simply right-click on the map to access the viewing options as described in "Map Options Menu" later in this chapter.

The map is also used to add and edit packages, ground forces and flights. After you've added some objects to the engagement, you can configure the flights and ground forces.

If you're not sure what the name is for a map icon, you can place your mouse cursor over the icon until a label appears.

Map Buttons

The Mission Builder map has buttons on the right side for adding forces to the engagement and viewing the map.

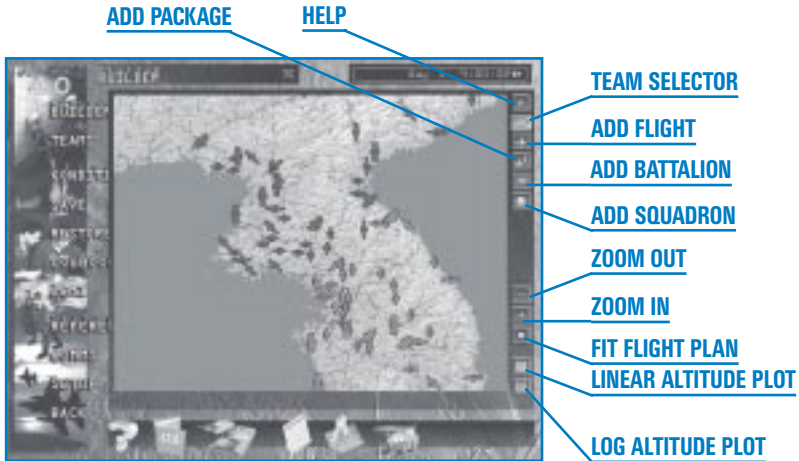

- Help** Press this button to display the Help window for the Mission Builder map.
- Team Selector** This button sets the current team. All units, flights and packages created will be added to the team displayed. Click on this button to switch to other teams. When you open the Tactical Engagement editor for the first time, two teams are provided: USA (blue) and North Korea (red).
- Add Flight** First, click the Add Flight button. Then click on a location or target on the map to display the Add Flight window. Add as many flights as you'd like, then click on this button again to turn Add Flight off. You can also add a flight by right-clicking on the desired target and choosing "Add Flight."
- Add Package** First, click the Add Package button. Then click on a location or target on the map to display the Add Package window. Add as many packages as you'd like, then click on this button again to turn Add Package off. You can also add a package by right-clicking on the desired target and choosing "Add Package."
- Add Battalion** First, click the Add Battalion button. Then click on a location or target on the map to display the Add Battalion window. Add as many battalions (army units) as you'd like, then click on this button again to turn Add Battalion off. You can also add a battalion by right-clicking on the desired starting location and choosing "Add Battalion."



- Add Squadron** Click this button to add squadrons to an airbase. To display airfields on the map, right-click on the map and choose Installations – Airfields. When the airbase icons appear, click on the Add Squadron button. Then click on an airbase (not an airstrip or highway strip) for that squadron. Click on the Add Squadron button again to turn it off. You can also add a squadron by right-clicking on an airbase and choosing “Add Squadron.”
- Zoom Out** Press this button to zoom out from the map, giving you more of an overall picture. If you have turned on the map labels and now find them unreadable, turn them off by right-clicking on the map and deselecting Names from the Map Options menu.
- Zoom In** Press this button to zoom in on the map, giving you a more detailed picture. Use this button when you want to select a specific target, steerpoint, etc.
- Fit Flight Plan** Press this button to reposition the map and zoom in to fit the chosen flight plan in the center of the map.
- Linear Altitude Plot** Press this button to display a side view of a selected flight’s altitude between steerpoints. Use this linear view for flights that remain near the same altitude throughout the flight.
- Log Altitude Plot** Press this button to display a proportional side view of a selected flight’s altitude between steerpoints. Use this view for flights with large changes in altitude between steerpoints.

Clock

The clock shows the current time in Tactical Engagement. If you are editing an engagement, you use the clock to assist you in planning by simulating the flow of battle. As you advance the clock, aircraft, vehicles and troops will move to their projected positions based on the time displayed.

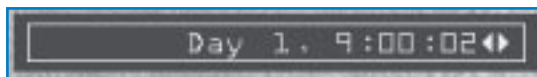

MAP MENUS

The Mission Builder map includes several different menus for adding elements and viewing options. Each of these menus is accessible by right-clicking on the map or in some cases on a map icon.

Map Options Menu

Right-click anywhere on the map that is not over a map icon to display the Map Options menu.



- | | |
|--------------------------------|---|
| Recon | Displays the Recon and Target List windows. The Recon window provides aerial photography of the target site. The Target List window allows you to select a specific target at that site. |
| Add Flight | Adds a flight to the currently selected team. Select this option to display the Add Flight window. |
| Add Package | Adds a package to the currently selected team. Select this option to display the Add Package window. |
| Add Battalion | Adds a battalion (ground units) to the currently selected team. Select this option to display the Add Battalion window. |
| Installations | Displays fixed assets by type. You can choose from Air Fields, Air Defenses, Army, CCC (Command, Control and Communications), Political (cities), Infrastructure (bridges), Logistics (depots and ports), War Production (factories and power plants) and Other (highways, borders and passes). Select Low, Medium or High from the Filtering submenu to view installations per their priority level. |
| Air Units | Displays air units by type. You can choose from Squadron, Fighter, Attack, Bomber, Support and Helicopter. |
| Ground Units | Displays ground units by type. You can choose from Combat (tanks, infantry and artillery), Air Defense (SAMs and AAA) and Support (supply, engineers and headquarters). |
| Show Packages | Displays packages for all teams. |
| Show Victory Conditions | Displays all the Victory Conditions icons. The icon looks like a diamond with its color corresponding to the team to which it belongs. |
| Threat Circles | Shows radar coverage. ADA (Air Defense Artillery) shows the coverage of SAMs and AAA. Radar shows the coverage of search radars. |
| Names | Turns on the map labels. This helpful feature lists the name of every flight, ground unit, airfield, installation and anything else on the map. |



Bullseye Turns on the bullseye, which is a common reference point used to specify locations. For more information, see the “Bullseye” section in **Chapter 21: The Radar**.

Other Menus

When you right-click on a map icon instead of the map itself, the pop-up menu will be tailored to the type of icon selected:

Installation Recon, Status, Add Flight, Add Package, Add Battalion, Add Victory Condition and Set Owner

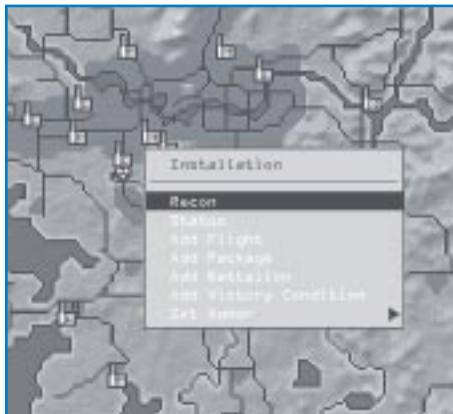

Squadron Recon, Status and Delete

Flight Recon, Add Flight, Add Package, Add Victory Condition, Status and Delete

Package Recon, Show Flights and Delete

Battalion Recon, Add Flight, Add Package, Add Victory Condition, Status and Delete

Adding a flight, package or battalion will create the appropriate unit with the chosen map icon as the unit's objective. Adding a Victory Condition will create a victory condition on the chosen icon. Selecting Status will open a status window appropriate to the chosen icon.

MISSION BUILDER TOOLS

The tools along the bottom of the screen provide intelligence options, weapons configuration, status reports and more.

Help

If you need help with Tactical Engagement, click the Help icon (which looks like a question mark).

ATO

The ATO (Air Tasking Order) displays all packages and flights planned in the engagement by team and mission type. The ATO can be used to view, find, edit and delete mission plans.

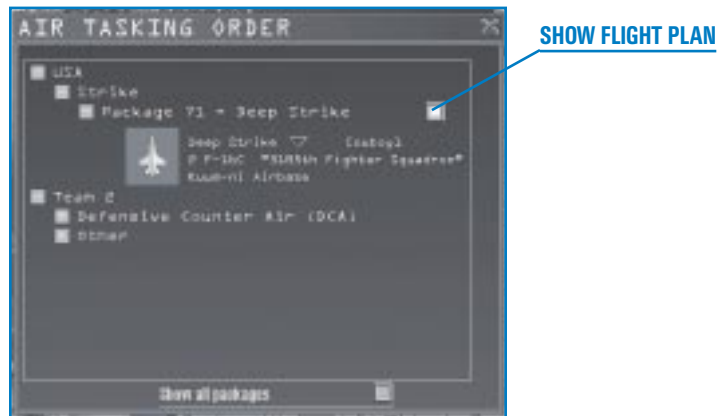

Team

Lists all teams in the mission. Click on the “+” sign next to a team name to see which types of missions are being flown.

Mission Type

Categorizes planned packages by type. Click on the “+” sign next to a mission type to see a list of packages.

Package

Click on the “+” sign next to a type of mission to see the assigned packages. You will see a package ID and the package type or mission role.

Flight

Displays the mission role, flight callsign, number and type of aircraft, their squadron name and their originating airbase.

Flight Plan

To see a flight plan, check the check box next to the package name and then select a flight.



Show All Packages If you're editing, click on this box at the bottom of the window to display all the packages in this tactical engagement for all teams. If you're playing a tactical engagement (vs. editing), you will see only the packages for your team. If the box is not selected, though, you will see only the flights in your package when you are playing.

OOB

The OOB (Order of Battle) is a list of armed forces and installations for all the teams in the tactical engagement. Click on the flag of a team (at the top of the window) to view its assets. Below the flags are buttons that control what types of assets are displayed for each team selected. From left to right, these asset types are air force, army, navy and installations.

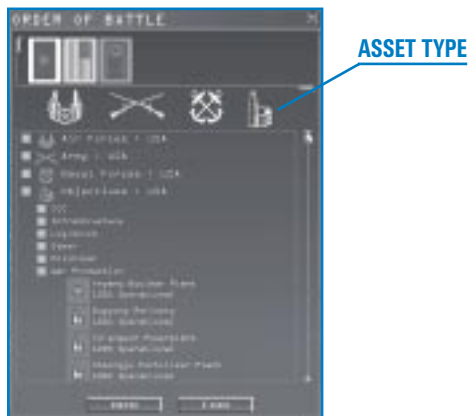

To browse through the information in the OOB, click on the "+" icons to expand a list and the "-" icons to close a list. Units assigned to a particular installation will be listed under that installation. (Squadrons, for example, will be listed under their home airbase.)

Click the Status button to open the selected item's status window.

Click the Find button to highlight the selected item on the map.



Flight Plan Window

Click on the Flight Plan icon at the bottom to access the Flight Planner window. You can also display this window by right-clicking a steerpoint on the Mission Builder map.

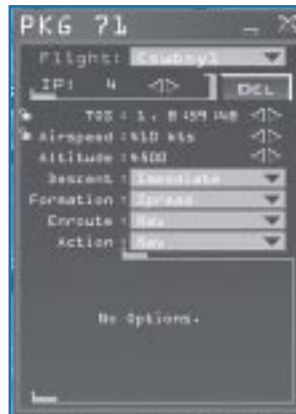

The Flight Plan window is labeled with the number of your flight package and provides the following information:

- Flight** Selects the flight you want to modify. If more than one flight is part of your package, you can select and change the route parameters for the other flights.
- STPT** Steerpoint. Use the arrows to cycle through the steerpoint numbers. For each steerpoint, you can change the TOS, the airspeed at steerpoint, the altitude, the climb action, formation, enroute action and general action.
- TOS** Time Over Steerpoint. TOS helps you coordinate various components of your package by ensuring that all the important pieces will be in the right place at the right time. To set the TOS, click on the days, hours, minutes or seconds field and it will turn green to show it's selected. Use the arrows to change the time. Setting the TOS automatically locks it and turns the padlock icon green. To unlock or re-lock the TOS, click on the TOS lock icon. When the lock is green and closed, the TOS is locked; when the lock is blue and open, it is unlocked.

Airspeed Set the airspeed for each steerpoint by clicking the arrows next to Airspeed. You can change airspeed in increments of 5 knots. Setting airspeed automatically locks it.

Chapter 27: Mission Planning and Execution has more information on adjusting TOS and airspeed for an entire package. If any entries are not possible for the flight, the line item and route will appear in red.

Climb/Descent Choose whether the climbout to the next steerpoint is immediate or delayed. Select Delayed in the Climb drop-down list to remain at the last steerpoint's altitude until just before arriving at the next steerpoint. Select Immediate to climb to the current altitude immediately after leaving the previous steerpoint.

Formation Select the formation of the selected flight. Choose from Spread, Wedge, Ladder, Stack, Trail, Res Cell, Box or Arrowhead. Read more about formations in **Chapter 23: Radio Commands**.

Enroute Set the actions of the flight enroute to a steerpoint. Only the actions applicable to the flight's mission role will appear in this list.

Action Sets the action a flight will carry out when they reach a steerpoint. General Action codes involve basic mission coordination, while Mission Action codes are available based on the assigned role of the flight. See the following table.

Steerpoint Provides pertinent information for a particular steerpoint. For example, if the steerpoint is set to Takeoff or Landing, the name of the airbase will appear in this area. You can delete a steerpoint by clicking on the Del button to the right of the steerpoint.

General Action Codes	Description
Nav	Navigate to next steerpoint
Takeoff	Depart airbase
Push Pt	Push (or marshal) point – where you join up with package
Split	Depart from package
Refuel	Air refueling point
Land	Land the aircraft
Pre-IP	Planning point prior to the IP
IP	Initial Point – the steerpoint prior to target at which the flight begins its attack run
Turn Pt	Turn point exiting the target area



Mission Action Codes	Description
Air Drop	Drop men, equipment or supplies
Attack	Attack ground troops
Bomb	Level bombing
CAP	Combat Air Patrol – defend area against enemy air forces
Contact	Await further instructions
ELINT	Electronic Intelligence
Escort	Protect other air assets from enemy air forces
FAC	Forward Air Control – coordinate ground attacks near friendly troops
Fuel	Refuel friendly air assets
Intercept	Intercept and destroy an assigned enemy flight
Jam	Jam enemy radar
Pickup	Pick up troops
Recon	Reconnaissance – take aerial surveillance photos at the steerpoint
Rescue	Rescue a downed airman
S&D	Search and Destroy
SEAD	Suppression of Enemy Air Defenses
Strike	Attack a fixed target
Sweep	Hunt down and destroy enemy aircraft

Munitions Window

Falcon 4.0 automatically assigns munitions to the flights you have created based on the type of mission. To change or review the default assignment, select the desired flight, then click on the Munitions button. The following sections outline every part of this window.

The top left side of the window displays the callsign of the flight being armed. A clock to the right of the callsign displays the time left until the flight is scheduled to launch. (When playing an engagement, you cannot rearm an aircraft after it takes off, but this limitation doesn't apply when building a mission.)



AIRCRAFT TABS

At the top of the Munitions window are tabs that represent every aircraft in the flight. You can make changes to any or all of the aircraft at the same time. All aircraft are initially selected. If you don't want to change the loadout of a given aircraft, click its tab so that it is not selected. You can reselect it by clicking again. Changes will apply only to the selected aircraft.

3-D MODEL

A 3-D representation of the aircraft that is being loaded appears in the top half of the window. This model can be rotated and zoomed with the controls to the right.

AIRCRAFT STATISTICS

Falcon 4.0 dynamically calculates the current loadout weight and drag of munitions attached to the aircraft being armed. Weight and drag are important factors because they dramatically affect an aircraft's flight model and turning ability. This information can help you determine the airplane's flight characteristics. Watch the gross weight closely; takeoff distances, landing distances and max G limits greatly increase when you match or exceed the maximum weight of the aircraft.

Max Weight	The maximum weight the aircraft can hold
Gross Weight	The total current weight of the aircraft
Clean Weight	Weight of aircraft without any munitions, stores or fuel
Munitions	The total weight of all loaded munitions
Fuel	The total weight of fuel (in pounds)
Drag Factor	A number indicating the amount of drag the current configuration produces

Munitions Drag and Weight

Munitions affect the drag, weight and balance of an aircraft. Each weapon has a drag coefficient associated with it. Drag increases fuel consumption, affects acceleration and reduces maneuverability. A clean aircraft has a drag factor of 1.0.

The weight of different munitions limits the flight performance of the aircraft and may limit the number of Gs a pilot can pull.

Heavy or asymmetric loads are called CAT III loads (vs. CAT I loads). The recommended maximum Gs for CAT III loads are 7.5 Gs. Flights with fuel tanks and an air-to-air loadout should not exceed a max G rating of 7.5. Air-to-ground munitions reduces the maximum Gs to 6.0.

Weapons also can affect an aircraft's balance. If you select asymmetrical loadouts, your aircraft will not fly "clean." For example, if you place 6 Mk-84s on the right wing and only 2 Sidewinder

missiles on the left wing, the airplane may handle unpredictably during heavy maneuvering because of weight and drag caused by the bombs. For this reason, try to keep everything symmetrical by adding the same number and type of munitions to both sides of the aircraft.

To learn more about aerodynamics, read **Chapter 25: Aerodynamics and G Forces**. To learn more about different weapons, see **Tactical Reference** in the game.

LOADOUT LIST AND INVENTORY

The Munitions screen includes features for selecting, saving, loading and restoring different loadouts.

Click on the Loadout display list (located in a blue box above the weapons column) to display the following options:

Loadout	The current loadout
Air-to-Air	All air-to-air weapons available for the selected aircraft
Air-to-Ground	All air-to-ground weapons available for the selected aircraft
Other	Fuel tanks, recon pods and jamming pods
All	Entire weapons inventory available for the current aircraft's hardpoints

When you select any of these options, you will see a list of the weapons that can be loaded on this aircraft. The numbered columns of the loadout chart represent the hardpoints of the aircraft being armed. The rows of the loadout chart display symbols representing the stores that can be loaded. If no symbol is shown in a column, the weapon cannot be loaded on that hardpoint.

To load a weapon, click on the store symbol below the desired hardpoint. If the symbol shows that multiple weapons can be loaded on a station, keep clicking until the desired number of weapons is loaded. The table below explains what the different store symbols mean.

Store Symbol	Empty	Full	# of stores
Single store			1
MER (multiple ejector rack)			2
TER (triple ejector rack)			3
Double TER			6
Large store			1
Internal store			varies

Blue	The weapon on that row can be loaded on that station, and that station is currently empty.
Bright Green	The weapon on that row is loaded on that station.
Dull Green	The weapon on that row can be loaded on that station, but that station currently has a different weapon loaded on it.
Striped Blue/Green	The selected aircraft have different types of weapons loaded on that hardpoint.

To select a munition from these inventories, just click on the hollow circles below the desired hardpoints. The circle will turn solid green, and the total quantity of this weapon type will appear in the Qty column. The item will also appear on the 3-D model. Each station will show how many weapons you can load of that type with the number of circles.

Note that supply restrictions are not modeled in Tactical Engagement. The Inventory column therefore will always display "HGH" (High).

MUNITIONS BUTTONS

The buttons at the bottom of the Munitions window are:

Save As	Click on Save As to save the current weapon loadout. You can save as many loadouts as you'd like and name them for future use.
Load	Click on Load to load a saved loadout for all selected aircraft in the flight. If an aircraft cannot carry a store on the hardpoint specified in the saved loadout, no weapon will be loaded.
Restore	Click on Restore to cancel any changes made but keep the Munitions window open.
Clear	Click on Clear to remove all munitions from the selected aircraft.
Cancel	Click on Cancel to cancel any changes and close the Munitions window.
OK	OK accepts the current loadout shown onscreen.

An Example of Changing a Loadout

The Tactical Engagement editor automatically configures loadouts for every flight created. To manually change the loadout for a flight, follow these steps:

Size	Sets the number of aircraft (1 to 4) assigned to this flight.
Squadron	Sets the squadron the aircraft in this flight are drawn from. If the squadron is set to "New," a new squadron will be created at the chosen airbase.
Airbase	If an existing squadron is chosen above, this field will display its home airbase. If a "New" squadron is set in the squadron field, it will be created at the airbase chosen here.
Target	Select the target you'd like to attack. The types of targets shown in the list depend on the Role chosen above. When you add a flight to the engagement, the point you click becomes the target for the flight.

Aircraft Mission Roles

The Role field in the Add Flight window lists the missions the selected flight can fly. The table below outlines the missions you can choose when building packages and flights.

Type	Purpose	To Achieve Success
DCA	Defensive Counter Air. A counter air mission designed to protect friendly assets in and around the station area.	Stay on station (unless redirected or relieved by AWACS) and ensure that no friendly targets in the station area are destroyed.
BARCAP	Barrier Combat Air Patrol. A counter air mission flown to protect a lane for a given period of time. DCA missions are tied more to a specific asset, whereas BARCAPs are used to protect a defined airspace from enemy approach.	Stay on station for the fragged time (unless redirected or relieved by AWACS) and do not allow enemy aircraft through.
HAVCAP	High Value Asset protection Combat Air Patrol. An air-to-air mission designed to protect an asset such as a friendly AWACS aircraft or tanker.	Ensure that the high-value asset is not destroyed during time on station.
TARCAP	Target Combat Air Patrol. An air-to-air mission designed to protect friendly attack aircraft at a target area.	Protect friendly aircraft at the target.
RESCAP	Rescue Combat Air Patrol Mission.	Protect rescue helicopters.
Ambush Cap	A counter air mission flown in an area shielded from enemy radar. Aircraft assigned this mission will evade detection for as long as possible so they can attack at close range.	Stay on station for the fragged time (unless redirected or relieved by AWACS) and do not allow enemy aircraft through.
Sweep	Aggressive counter air patrol into enemy territory.	Kill as many enemy aircraft as possible without taking losses.
Intercept	Air-to-air interception of enemy aircraft.	Destroy assigned target or force them to abort their mission.
Escort	Protect a strike package from enemy aircraft.	Ensure the package reaches the target with no losses from enemy aircraft.



Type	Purpose	To Achieve Success
SEAD Strike	Suppression of Enemy Air Defenses.	Reduce enemy air defense assets by destroying radar or launch vehicles.
SEAD Escort	Suppression of Enemy Air Defenses. Protect a strike package from enemy air defenses.	Ensure the package reaches the target with no losses from enemy air defenses.
OCA Strike	Offensive Counter Air strike. A mission flown against enemy assets (such as airbases or search radar systems) designed to help obtain air superiority.	Make sure you hit the assigned target or reduce the operational status of the installation by at least 30%.
Strike	Air-to-ground mission flown against a wide variety of enemy targets.	Hit the assigned target or reduce the operational status by at least 30%.
Deep Strike	Air-to-ground missions flown against a wide variety of enemy targets deep in enemy territory.	Make sure you hit the assigned target or reduce the operational status by at least 30%.
FAC	Forward Air Control. As part of an On-Call CAS package, FAC aircraft locate and assign enemy targets to CAS aircraft.	Assist in the destruction of as many enemy vehicles as possible.
On-Call CAS	Close Air Support. CAS missions are strike missions flown against enemy army units that are in close proximity to friendly forces. Specific CAS targets are usually passed to the fighter from a FAC.	Destroy as many enemy vehicles as possible.
Pre-Plan CAS	Pre-planned Close Air Support. Pre-planned CAS missions are flown against known targets, usually without the assistance of a FAC.	Destroy as many enemy vehicles as possible.
CAS	Close Air Support.	Destroy as many enemy vehicles as possible.
Interdiction	Air attacks on enemy logistics and reinforcements moving toward the front.	Cause as much damage to the target as possible.
Recon	Reconnaissance. Mission designed to photograph a target site for intelligence purposes.	Photograph the target from within 2 miles slant range.
BDA	Battle Damage Assessment. BDA missions are identical to reconnaissance missions except they are flown to get post-strike pictures of the target area.	Photograph the target from within 2 miles slant range. You must photograph the target after the attack.
Anti-Ship	Strike enemy naval forces.	Cause as much damage to the target as possible.
Training	Practice missions flown prior to battle.	A sortie that is designed to teach a particular method or idea.

These missions are available depending on the type of aircraft being flown.

Add Package

To see packages on the Mission Builder map, right-click and select Show Packages. The package icon will appear wherever there is a package target.

Open the Add Package window to create packages. Click on the Add Package icon on the right side of the Mission Builder map and click on a target or location on the map to open the Add Package window.



- | | |
|-------------------------|--|
| Package Type | Tactical objective of the package. The package type is taken from the mission role assigned to the first flight created for the package. (It will read "None" until a flight is created.) |
| Target | The location you chose on the map when creating the package. If you change the target of the first flight created for the package, the target will be updated to reflect the change. |
| Flights | This lists all the flights in the package. |
| New | To add flights, click on the New button. The Add Flight dialog box appears (see the section "Add Flight" above for details). To add a second flight to the package, simply click on New again and design the second mission. |
| Edit | Edit an existing flight listed in the Flights window. Click on the flight to highlight it, then press the Edit button. The Add Flight window will appear. See "Add Flight" above for details. |
| Delete | Delete a flight from the package. If you delete all the flights in a package and then click on OK, the package no longer exists. There has to be a flight in the package for it to exist. |
| Package Priority | Provides an alphabetical priority rating you assign to each package. "A" is the highest priority. Flights can be organized by priority later in the Mission Schedule window when you load an engagement. |
| Takeoff | Displays the desired takeoff time for flights in a package. Locking the takeoff time (by clicking on the padlock icon) will force the planner to assign this takeoff time to all flights in the package. This may make it impossible for the planner to get all flights to the target at the same time (especially if they are flying from different airbases or are different kinds of aircraft.) |



Time On Target

Displays the desired time for the first flight in the package to reach the target. When the TOT is locked, the planner will adjust takeoff times as necessary so that each part of the package arrives at the appropriate interval.

Add Squadron

The Add Squadron Window allows you to set the attributes of a new squadron. Open the window by clicking on the Add Squadron button and then choosing a home airbase on the Mission Builder map.

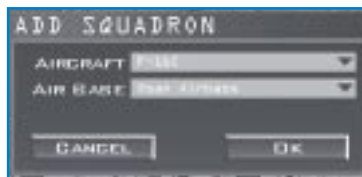

Aircraft

Displays a list of aircraft available in *Falcon 4.0*.

Airbase

Displays the airbase to which the squadron will be assigned.

Squadron Status



Once it is created, a squadron can be reviewed in the Squadron Status window. To open this window, select the squadron in the OOB window and click the Status button. You can also right-click on the squadron icon on the map and choose "Status" from the pop-up menu.

The Squadron Status window can be used to view how many aircraft and pilots a squadron has as well as mission performance. No resupplies occur during a tactical engagement, so if a squadron loses too many of its aircraft, it will cease to be an operational unit. Weapons and fuel, however, are available in unlimited supply.

Add Battalion

Tactical Engagement includes capabilities for adding a full range of ground forces. To add battalions, click on the Add Battalion button to the right of the Planning Map or right-click on the planning map and choose Add Battalion to open the Add Battalion window.

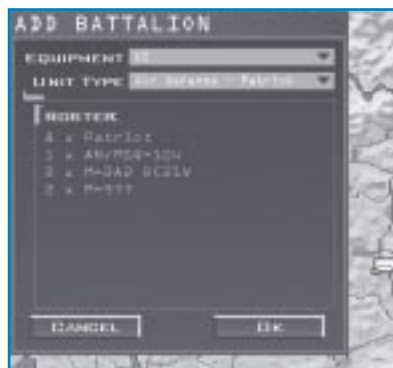

Equipment

The different types of ground forces. Since different countries organize their armies differently, this list shows the different countries in *Falcon 4.0*.

Unit Type The types of units available for the country chosen under Equipment.

Roster The men, weapons and vehicles that will be assigned to the new unit.

Once a battalion is created, give it marching orders by clicking on the unit and then dragging its steerpoint to the desired location. The unit will move to the assigned location, capturing it if necessary, then assume a defensive posture until further movement orders are received.

When you place SAMs and air defenses, they may “snap” to a spot on the map different from where you clicked. *Falcon 4.0* determines the best location for SAMs and other air defenses based on the topography near the point where you clicked. If you place a mobile SAM and set a steerpoint, the SAMs do not fire while moving.

All the battalions in a mission will appear as icons on the map (if the display of ground units is turned on) and in the OOB. Although you can add as many battalions as you’d like, remember that if a small area has numerous ground objects, frame rate will diminish considerably.

Battalion Status



Once it is created, a battalion can be reviewed in the Battalion Status window. To open this window, select the battalion in the OOB window and click the Status button. You can also right-click on the battalion icon on the map and choose “Status” from the pop-up menu.

Use the Battalion Status window to review the orders and equipment assigned to a battalion. If the unit has been given orders to move, the estimated time that it will arrive at its destination is displayed. A unit’s orders are determined by what type of unit it is and where it has been ordered to go.

TEAMS

Click on the Teams button on the left side of the screen to access the Teams window. This window allows you to create teams and set the territory each team controls.

Each flag along the top of the screen represents a separate team in the engagement. You can edit and plan missions for all teams, but you can only fly one team’s missions when you play the tactical engagement. All teams in a mission are hostile. If their forces come into contact, they will attempt to destroy one another. No alliances are possible.





When you create a new mission, two countries are added by default: USA in blue and North Korea in red. You can add a new team by clicking on the New button at the bottom of the screen or remove one with the Delete button. The following attributes can be set for a team:

Name	The name of the team. Click in this field and then type in a new name.
Flag	The team's flag. Use the arrows next to the flag to select your flag.
Colors	The team's color. This color is used for map displays and icons in the Mission Builder map and label colors in the simulation.
Pilot Skill	Represents the average skill of all personnel on the team, including ground forces. The skill distribution is a bell-shaped curve centered on the average skill rating you have selected. This setting affects the AI and realism in the actual sortie or engagement you create in the Tactical Engagement editor.
ADA Skill	Sets the average skill of Air Defense Artillery operators for the team. This setting influences the accuracy of the air defenses, which are controlled by the computer AI.
Mission Statement	Type the overall mission objective for the team in this area. This statement is displayed in the Mission Description area.

Changing the Theater Map

To assign a region of the theater to a team, select the desired team and then paint the map with the paintbrush tool. All installations in the area painted will be assigned to the specified team. (Installations can also be assigned individually by right-clicking on the installation in the OOB or on the Mission Builder map and selecting "Set Owner.")

Paintbrush	Assigns the area painted to the currently selected team. Right-clicking will perform a color fill operation.
Eraser	Clears the area painted so that it is assigned to no team. Right-clicking will clear an entire region.
Clear	Clears the entire theater.
Undo	Undoes the last operation performed on the map.

VICTORY CONDITIONS

Victory conditions determine which team wins a mission. To win a mission or engagement, a team must score at least the required number of points by accomplishing the tactical objectives listed in the Victory Conditions window. These objectives include capturing installations, destroying structures and units, and intercepting specific enemy aircraft. It is the mission builder's responsibility to create victory conditions and assign the points necessary for a team to win.

Each condition should be assigned a point value that is awarded to the specified team when the condition is fulfilled. When one team surpasses the Points for Victory total, a victor is declared. (If more than one team scores above the total, the team with the highest point value wins.)

The Victory Conditions window also contains three other important elements: the Mission Type, the Start Time and the Time Limit.

Mission Type

Click on the Mission Type drop-down menu to select between Sortie and Engagement. The biggest difference between these two types of missions is based on time.

Sorties

Sorties are short-term missions. The mission clock does not start until the player enters the aircraft, and all victory conditions must be achieved before the player ends his sortie.



Engagements

Engagements can be more complex than sorties. The player can fly several missions to accomplish the victory conditions. The scenario can last several days, only ending when one team scores enough victory points to win the mission or when the time limit expires.

Start Time

Set the Start Time for the sortie or engagement by clicking on the time and then pressing the arrows. Start Time actually controls the *entire* sortie or engagement start time. When you set a start time for 1100 (11:00 AM), for example, this time will appear in the Mission Schedule window later on when you load the saved engagement and choose to fly a mission. The entire tactical engagement will start at 1100. If you set a start time of 2300 hours, the engagement will start at that time (and you'll see 2300 hours in the clock when you load the engagement).



Time Limit

The Time Limit setting controls the end of the engagement or sortie. If you'd like to limit the time a player has to fly a sortie or limit the time an engagement lasts, set the time limit for either in this window. For example, if no team achieves its victory condition in the time limit set, then the tactical engagement will end in a stalemate. Keep in mind that the first number for both Time Limit and Start Time represents the day in the engagement. For example, "2, 11:00:00" means Day 2 at 11:00 AM.

Points for Victory

Set a total points for victory that is the total number of points needed to win an engagement. Suppose, for example that you create four victory conditions for one mission and each victory condition yields 100 points when executed successfully. If you type "300" in the Points for Victory field, the player could accomplish any three of these conditions to win the mission.

Teams

The Teams list shows the total points possible for each team during the design phase of the engagement. For example, if three Victory Conditions have been created for the North Korean team and each condition is assigned 100 points, then that team's maximum possible point total in the Teams list would be 300. (When playing a mission, the points column will show how many points each team has already earned.)

Victory Conditions Map

This map is essentially the same as the Mission Builder map. To move the map, simply click on an empty area and drag the mouse. The map is used to assign targets to victory conditions.

Victory Conditions List

Use the New and Delete buttons in the Victory Conditions window to add new victory conditions and to delete existing ones. Victory conditions are assigned by team, and only the specified team can earn points for achieving the objective outlined in the condition.

To create a victory condition:

1. Click on the New button in the Victory Conditions window.
2. Select the team that will receive (or lose) points if the condition is fulfilled.
3. Click the underlined word "Assign" which appears under the Victory Condition column to assign a target.
4. Choose the desired target of the victory condition on the map. (Drag, zoom and adjust the map display if necessary.)
5. Set the victory condition type. Only those applicable to the target you chose on the map will appear in the list.

Occupy applies only to Installations. Points will be awarded when the specified team occupies the installation after the specified time interval. Only ground units can occupy an installation. If the installation is recaptured after the time interval, the points will still be awarded. To force a team to hold an installation for the entire engagement, set the time interval equal to the mission time limit.

Destroy applies to specific buildings or structures at an installation. After choosing the target installation, set the specific structure to be destroyed.

Degrade applies to installations only and is modified with an operational percentage. To earn the points, the specified team must destroy enough of the targets at an installation to reduce its operational capacity below the specified percentage. This may require that several targets at the installation be destroyed.

Attrit applies to ground units. To earn the points, the team must destroy the specified percentage of the unit's vehicles and personnel.

Intercept applies only to a specific flight. To earn the points, at least the specified number of aircraft in the flight must be shot down.

6. Enter the number of points to be awarded when the victory condition is fulfilled. If the point value entered is negative, the assigned team will lose points.

You can also add victory conditions by right-clicking on targets directly on the map and selecting "Add Victory Condition" from the menu.

SAVE AND RESTORE

To save an engagement, click on the Save option on the left side of the screen. You can save your engagement at any point as you edit. Tactical Engagement sorties and engagements are saved with the .TAC extension in the \CAMPAIGN\SAVE directory in the default *Falcon 4.0* directory.

Click the Restore button on the left side of the screen to restore the tactical engagement that you are editing to its last saved state.

EXITING A TACTICAL ENGAGEMENT

You have the same choices while flying a mission in Tactical Engagement as you do a mission in the Campaign. First, press **[Esc]** and then select one of the three options below:

- | | |
|------------------------|---|
| End Mission | Select End Mission to leave the current flight and return to the Mission Schedule window. Whatever successes or failures that occurred during the mission will be weighed against the team. |
| Discard Mission | Select Discard Mission to exit the mission and return to Tactical Engagement as if you had never flown this mission. |
| Resume Mission | Select Resume Mission to return to your current mission. |

CHAPTER

12



CAMPAIGN

The Campaign section of *Falcon 4.0* separates fighter pilots from cannon fodder. Once you enter the campaign, all your skills, training, instinct and experience will be tested. The campaign is the real thing. You're thrown into a chaotic military action, given a job to do and must prove your mettle in combat.

The campaign takes place in the volatile Korean peninsula, one of the hotbeds of military activity. Ever since the Korean War "ended" in 1953, tensions between North and South Korea have continued. These two countries are—to this day—technically in a state of war. In *Falcon 4.0*, tensions have reached their breaking point... and this time there's more than rhetoric flying.

UNDERSTANDING THE CAMPAIGN

The campaign consists of three different scenarios that take place in the Korean peninsula; each scenario represents a specific military condition. Once you enter one of these scenarios, you are placed in the middle of a significant military action involving ground, naval and air assets, as well as military forces from the U.S., North and South Korea (and potentially China, Russia and Japan).

You play the part of a U.S. fighter pilot. You choose the squadron you want to fly with and pick your mission from a daily list of sorties being generated by headquarters. This headquarters is called Air Command (short for Air Component Commander) in *Falcon 4.0*. The Air Component Commander and his staff work directly for the war-fighting CINC (Commander in Chief) in the theater. (In the Gulf War, for example, the war-fighting CINC was Army General Norman Schwarzkopf and the Air Component Commander was Air Force Lt. General Chuck Horner.) The Campaign in *Falcon 4.0* is set up with a similar structure.

The ATO (Air Tasking Order) is called the frag (for "fragment"), which is an enormous document that covers every Air Force and Navy aircraft in an entire theater of war. Your squadron gets its piece of the air war assigned via the frag. The mission schedule represents the "fragment" of the ATO that is being assigned to your squadron in the form of your mission schedule. You can fly several sorties a day, and the campaign can last for many days. Although you are one of many hundreds of pilots flying in this war, your success or failure will affect the outcome of larger strategic situations. It's time to take your flying seriously and put your training to work.

An important thing to note about the Campaign is that it takes place in real time. This means that air and ground movements occur simultaneously in the Campaign and continue even when you are not in the aircraft. While you study intel or reconfigure the steerpoints for your mission, other missions are being flown and the face of the war continues to change.



JUMPING INTO THE CAMPAIGN

If you are ready to join the battle and fly now, you can accept the default campaign settings and jump into battle. To join the campaign quickly, follow these steps:

1. Click on Campaign at the main menu.
2. Click on one of the three campaign scenarios: Tiger Spirit, Rolling Fire or Iron Fortress. Sit back and watch a video of the current military situation.
3. Click the Commit icon in the bottom right-hand corner (which is the F-16 icon).

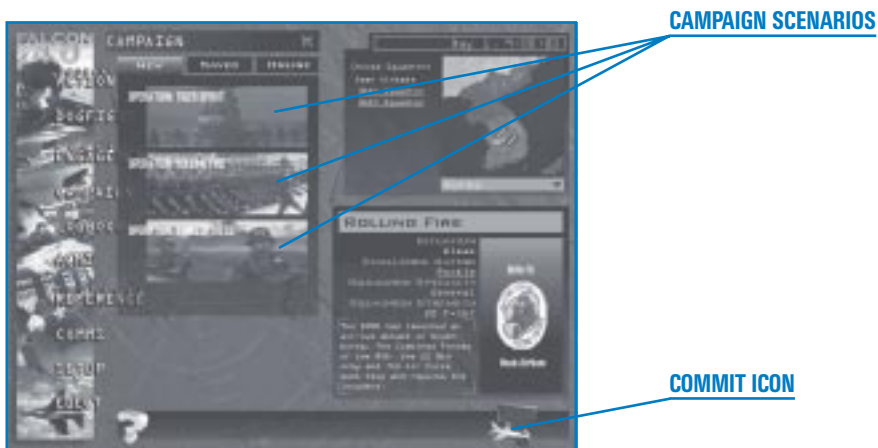

As the Mission Schedule screen loads, the Campaign fills in the Mission Schedule window with missions you can fly. You can select any mission in the Mission Schedule but since you can only fly one at a time, missions that you do not fly are flown by the computer.

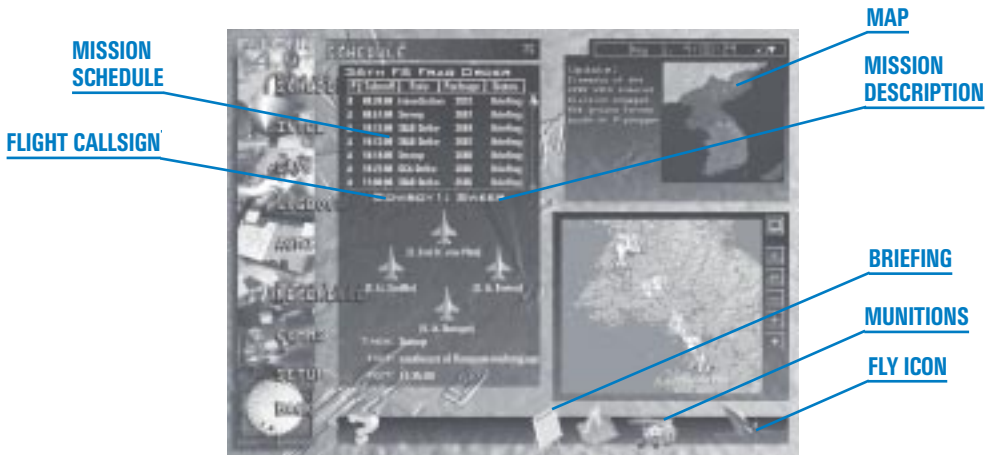

4. You will automatically be placed in the lead aircraft of one of the first generated missions. If you want to choose a different mission, click on any mission in the Mission Schedule and choose your plane in that mission. You can choose from air-to-air, air-to-ground, recon and other types of missions. For a detailed list of missions available to the F-16 and an explanation of Air Force acronyms used in missions, check out the section "Aircraft Mission Roles" in **Chapter 11: Tactical Engagement**.
5. Choose your plane in the squadron by clicking on the aircraft of your choice below the mission list. The #1 aircraft is always the flight lead. Note your flight callsign. The name is to the left of the colon that precedes the mission descriptions above the aircraft. Flights normally consist of either two or four aircraft. The #2 position is the flight lead's wingman. The #3 position is the lead of the second element, and the #4 position is #3's wingman. #1 is still the overall leader of the flight.
6. Click on the Briefing icon on the bottom of the screen to review your chosen mission. Review the mission objective labeled "Your Task." Next, scroll down the mission briefing and note your weapons loadout and steerpoint information. Close this window when you're finished by clicking on the "X" in the upper right-hand corner.



- Examine the area through which you will be flying on the Mission Map in the bottom right corner. Review the loadout of your aircraft and the entire flight by clicking on the Munitions icon. If your mission is in flight, you will not be able to change the munitions or flight plan.



- Click on the Fly icon in the bottom right corner. If your flight has already taken off, you can jump into your airplane anywhere along the route to the target as long as the flight has not yet reached the ingress point. Look at the Planning Map to see if the flight is approaching, but not past, the IP (Initial Point) marker on the flight path. The IP marker is a square steerpoint marker. If the plane is anywhere before this point, you can enter the flight.

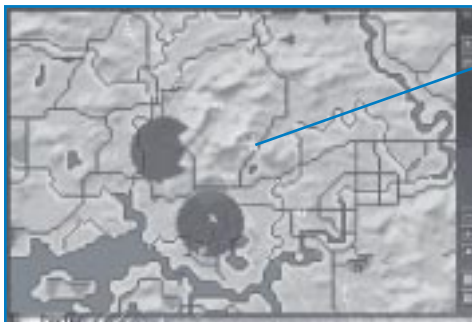

INITIAL POINT

9. If you have selected a flight that has not yet taken off, a countdown screen appears when you click the Fly icon. It displays a digital countdown timer and two ground starting point options: Taxi and Takeoff.
10. Click on Taxi if you'd like to be on the taxiway or you need some extra time to set up. Select Takeoff if you'd rather be positioned for takeoff when you enter the cockpit.

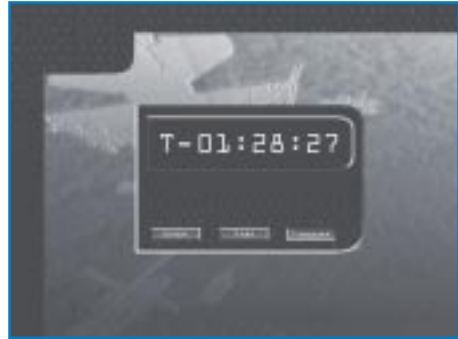

At this “countdown” screen, *Falcon 4.0* speeds up the clock to your selected mission departure time. You will hear a number of pilots, air traffic controllers, and AWACS personnel communicating over communication channels and flying sorties as *Falcon 4.0* conducts the war. Hundreds of sorties, ground troops and skirmishes are taking place as you approach your taxi time.

11. When the countdown clock reaches zero, the simulation will load. As the simulation is loading, you will see a preflight screen. Then you will appear, depending on your selection, on the taxiway or runway cleared for takeoff. Your mission has begun. Make mama proud!

SAVING YOUR CAMPAIGN

After you choose a campaign and enter the Mission Schedule screen, you can save the campaign by clicking on Save on the left side of the screen. Simply give the currently running campaign a name and click on the Save button.

The Campaign also has an automatic save feature that automatically saves the state of the campaign at three different points:

- ✦ When you click on the Fly icon to enter the simulation
- ✦ When you press **[Esc]** in the simulation and select “End Mission”
- ✦ When you click the Back button to return to the main menu

Falcon 4.0 creates an autosave file named “Auto Save.” You can rename this file by clicking on the Save button.

If you press **[Esc]** and discard the mission, you will return to the point in campaign time when you clicked the Fly icon to fly the mission you just ended. In this case, the campaign will not be saved.



This quick start for the campaign accepts all the default settings provided by *Falcon 4.0*. The Campaign screens provide numerous options you can change. This chapter will show you how to use these options to influence entire battlefield scenarios and missions, configure squadrons, adjust munitions loadouts, and plot new steerpoint courses and objectives before joining the virtual battlefield.

CREATING A NEW CAMPAIGN

Falcon 4.0 provides different screens to help you create a campaign and adjust mission parameters as part of the war effort.

The Preliminary Campaign screen lets you start a new campaign, load a saved campaign, set enemy skill level, adjust force levels between North and South Korean armed forces, and play a multiplayer campaign.

The Mission Schedule screen lets you select and configure missions, adjust mission priorities, change weapon loadouts and gather intelligence at this screen.

The



lets you examine all known intelligence on the enemy and allied forces, such as JSTARS displays, troop sizes, packages, the Air Tasking Order and the Order of Battle.

You will use each of these screens prior to flying a campaign mission. The following sections walk you through the options available on each of these screens for creating new campaign missions and modifying existing missions.

PRELIMINARY CAMPAIGN SCREEN

Click on Campaign at the main menu. The Preliminary Campaign screen will appear, which is the first step in creating and configuring a *Falcon 4.0* campaign. From this screen, you can:

- ✦ Select, load or join a campaign scenario
- ✦ Choose your squadron

- ✦ Set the challenge rating and determine the ratios of opposing forces

The Campaign screen consists of three areas for adjusting these parameters: the campaign selection area, the airbase display map and the scenario detail screen.

Campaign Selection

The campaign selection area in the top left of the screen allows you to start one of three battle scenarios, load a saved campaign or join an online campaign.

THE SCENARIOS

Falcon 4.0 provides three scenarios possible in the continuing Korean conflict:

Tiger Spirit

North Korea, weakened from years of isolation and a decaying economy, makes an ill-conceived attack on South Korea—but quickly finds itself in trouble. Its attack is quickly repulsed, but the pressure remains as the combined allied forces decide to push North Korea back and keep its forces from reorganizing.

Rolling Fire

With a failing economy and a vast million-man army poised for battle at the border, North Korea is hungry for conquest. Tensions are high, and war has just begun. North and South Korea are evenly balanced—and the bubble has finally burst.

Iron Fortress

North Korea makes a bold, lightning strike into the south, overwhelming South Korea with a combination of surprise and the fierceness of its attack. It has the advantage and South Korea, along with its allies, is pushed into a serious defensive position. In days North Korea could break through the Pusan perimeter. The situation is desperate. It is up to the allies, and in particular U.S. air power, to hold the line and slow down the

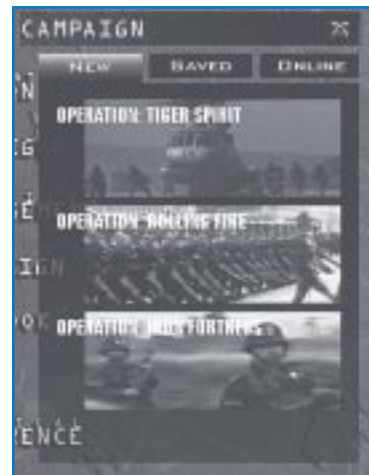



North Korean onslaught.



Choose one of these conflicts by clicking on the picture for the conflict. You can also load a saved conflict or join an ongoing online campaign.

LOADING SAVED CAMPAIGNS

If you've previously saved a campaign, load it by clicking on the Saved tab and selecting the campaign you want to load. Now click the Commit icon in the bottom right corner and the saved campaign will start.

If you relied on Auto Save to save your campaign or mission, click on "Auto Save" in the Saved window and then click on the Fly icon. The campaign will pick up where you left off when the fly icon you exited the Mission Schedule window.

For information on joining or hosting an online campaign, see the **Communications Handbook**.

Theater Map

The Theater Map in the upper right corner of the Preliminary Campaign screen displays the relative positions of enemy and ground forces on the Korean peninsula, the available F-16 airbases, the current time and day of the war, and the squadrons based at each airbase. Select the airbase from which you'd like to fly by clicking on the airbase icon. Then choose a squadron to the left of the Theater Map.

AIRBASES

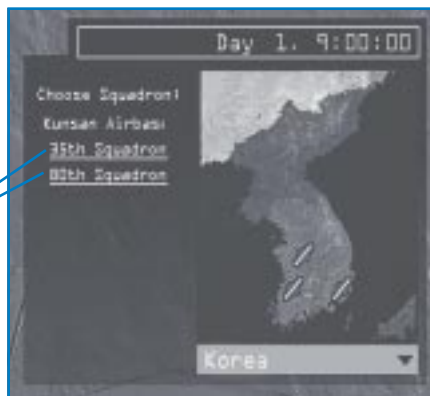

Note that *Falcon 4.0* will automatically assign you to an airbase if you forget to select one. If you select an airbase, you may still be reassigned to another airbase when you enter the Main Campaign screen. This happens when an airbase has fallen under attack, your squadron has run out of aircraft or your airbase becomes too close to the front lines. A pop-up dialog box will appear on

the Main Campaign screen informing you of a redeployment to a new airbase if this occurs.

Scenario Overview

The Scenario Overview part of the Preliminary Campaign window provides an overview of the scenario you're about to enter. Four areas provide information on ratings and strength:

Situation provides an overall sense of the situation in one of five categories: Bleak, Poor, Fluid, Good and Excellent.

Challenge Rating provides four settings that influence the power of the enemy in the campaign. The overall Challenge Rating changes based on the force composition levels. You can adjust these levels by using the slider bars at the bottom. The slider bars represent the ratio of force levels between North Korea (the DPRK) on the left and South Korean allied forces on the right. Slide the scale to one side and you tilt the ratio of forces in one side's favor, increasing the need for you to be an ace pilot or giving you some room to breathe if you're still a recruit. You are not reducing forces to zero but providing more forces for the enemy and thus increasing the difficulty. The Pilot Skill setting and the ADA (Air Defense Artillery) Skill setting can also be adjusted; these settings determine the quality of the enemy. Once the campaign begins, the force ratios are locked and cannot be changed.



Squadron Specialty describes the makeup of the majority of F-16 missions in the campaign. Some squadrons are primarily tasked with air-to-air missions and some with air-to-ground missions. If you mainly want to move mud, for example, select a squadron that specializes in air-to-ground missions.

Squadron Strength displays the number of aircraft in the squadron. Below the strength is a description of the current situation.

Squadron Number and Patch displays the squadron selected for the campaign (not the virtual squadron selected in the Logbook).

After you've adjusted these levels, click on the Fly icon in the lower right corner to continue to the Campaign's main screen.

MISSION SCHEDULE SCREEN

As the Mission Schedule screen loads, it creates a number of missions available to your squadron. When the missions appear, the campaign begins and the clock starts ticking. New menu items and options appear on the far left side of the screen and in several windows.



The Mission Schedule screen consists of three areas that help you prepare for a mission:

Mission Schedule Every mission available to your squadron. You can organize the missions by priority, takeoff time, package number, status and type. Click on one of the priority tabs along the top of the Mission Schedule. Click on the mission you'd like to fly.

Event Map A map of the Korean peninsula showing the current battle situation, recent high activity and communiqués. The clock displays the number of days in the current campaign as well as the time of day.

Planning Map A complete tactical view of the Korean conflict. Move your mouse over the map; when the cursor appears, right-click on the map to display airbases, objectives, flight plans, ground troops, air defenses and other important military information.

Mission Schedule

The first step in entering the Campaign is to select a mission. The Frag Order for your squadron lists all the missions being flown by your F-16 squadron over the next few hours. The missions are listed chronologically by default, but you can reorganize the list by mission priority (P), takeoff time, mission type (Role), package and mission status. Simply click on one of these tabs. When a new campaign starts and each time you return to this screen, *Falcon 4.0* selects one of the first missions on this list and places you in the lead aircraft by default.

Scroll through the Frag Order and select any mission on the list that you want to fly. Information for this mission will appear below the Frag Order and also as a flight plan in the Planning Map. Keep in mind that you can only join missions that are in briefing or enroute. As the war progresses, all missions will be flown and take off at their designated

FRAG ORDER

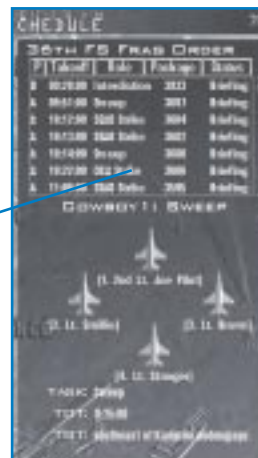

takeoff times. Therefore, a particular mission may not be available to you because the AI is flying the mission and is ingressing to the target.

SELECTING AN AIRCRAFT

Your flight consists of from one to four F-16s. Below your assigned flight callsign, you'll see icons for each aircraft in the flight, along with the ranks and names of each pilot assigned to the flight. Pick the aircraft you want to fly by clicking on it. Your own name (the name from your Logbook) will appear under the aircraft. If you select the #1 aircraft, you will fly in the lead position. A recap of the task, your target and time over target appear under the aircraft lineup.

(Remember, to add your name to the Logbook, click on the Logbook button on the left side. You can then type information into the Logbook to create your pilot persona.)



Event Map

The Event Map shows hotspots developing in the Korean conflict on the map. As skirmishes erupt and die out, communiqués from JSTARS (Joint Surveillance Target Attack Radar System) and HQ (Headquarters) flash by on the text area next to the map. The clock at the top of the Event Map can be changed from Stop to 64 times normal time. The war rages continuously

until one side has an overwhelming advantage or by political means, when both sides agree to a stalemate. This timeframe can vary from one day to many weeks.

News Reports

Whenever a major event occurs in the campaign, a video of a news report will play. Once one of these news reports is aired, a "News Reports" button will appear in the Event Map area. Click this button to access all previous news reports in the campaign. Reports are listed by date and time.

Adjusting the Campaign Clock

All campaigns start on Day 1. The clock advances normally as the campaign proceeds. If you're not ready to jump into battle but would rather see how a campaign is developing, you can speed up the clock 2, 4, 8, 16, 32 or 64 times. If you speed up the clock, missions will take off quickly so watch the clock closely to ensure you don't miss out on your mission.

If you need some time to check out the latest enemy intelligence, review your briefing for a mission or change a weapons loadout, you can also stop time completely by selecting "Stop" from the clock's drop-down list.



One way to see the rapid development of the war is to speed up the clock and then check out the JSTARS display in the Intel section. This will allow you to see troop movements over the course of the campaign.

To change time in the simulation, press **Tab** to accelerate time. You will see "x2" flashing in red on screen. To accelerate time to its maximum, press **Caps Lock** and you will see "x4" flashing on screen. Of course, you can also press **P** to pause the game or **Shift P** to freeze the game.

Planning Map

After you select a mission, its flight plan appears on the Planning Map. This is an invaluable tool for planning and adjusting your mission. The Planning Map includes a wide variety of information and tools for viewing your flight plan and making changes to your mission.

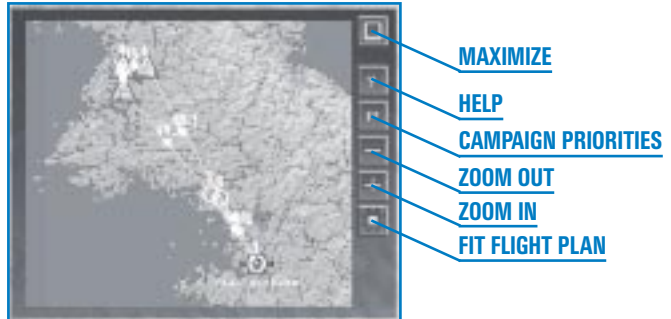

The buttons on the right side of the Planning Map area are described to the right.

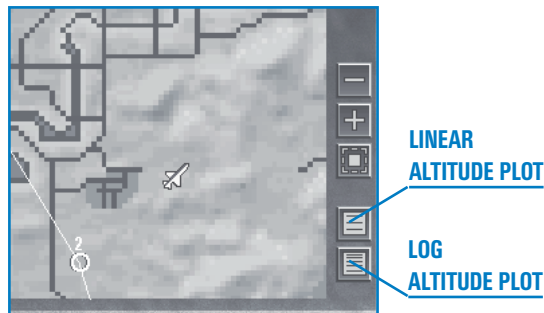

MAXIMIZE

Press the Maximize button to enlarge the Planning Map to fill the screen. In addition, two new buttons are added:

Linear Altitude Plot Displays a side view of the selected mission's flight plan. This view shows the altitude your flight will fly between each steerpoint.

Log Altitude Plot This side view is a larger scale version of the linear plot view and is another way to alter your altitude changes for the flight plan.



HELP

Press this button to access online help.

CAMPAIGN PRIORITIES

The Campaign Priorities button allows you to influence the types of missions created for your squadron's Air Tasking Order. You cannot change the ATO by changing these mission priorities, but you can request that more of one type of mission (air-to-air, for example) be assigned to your squadron, if those missions are available. Future missions are affected, but your current frag order does not change. The Air Command will still find the best assets, which may or may not include your squadron, to achieve its goals.

If the "Set by HQ" button on the Priorities dialog box is green, the Campaign engine sets your squadron's priorities automatically. As soon as you make any changes using the sliding bars, this button will automatically be deselected. If you make changes but then want to return to the original settings, simply click on the "Set by HQ" button again to restore all the original settings.

The PAKs tab on the Priorities dialog box allows you to request more missions be flown in the selected PAK (route package). Click on the PAK and raise or lower the priority slider. The darker the red, the higher the priority. Note that if you set all of the priorities to high, then you are telling the computer to set all the priorities the same. If you want concentration in one area, then you must give up assets elsewhere.

ZOOM OUT

Press the zoom out button to zoom out on the map.

ZOOM IN

Press the zoom in button to zoom in on the map.

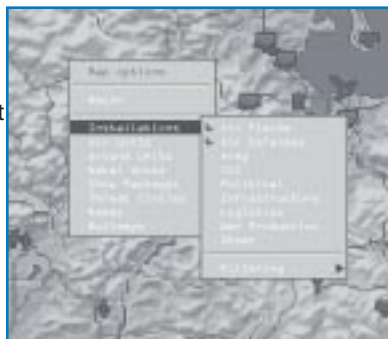



FIT FLIGHT PLAN

Press the Fit Flight Plan button to reposition the map and zoom in to fit the chosen mission's flight plan in the center of the screen.

THE PLANNING MAP MENU

With the Planning Map enlarged, right-click on the map. A pop-up menu will appear with options for display overlays to show you the complete tactical situation into which you'll be flying. Keep in mind that enemy intelligence is based on imperfect information. The fog of war applies to *Falcon 4.0*'s campaigns as much as an actual conflict.



Options you can display include:

Recon provides strategic information and a 3-D view of a specific target or location on the terrain.

Right-click on the area of interest and chose Recon from the drop-down menu. The Recon window will open and provide zoom, pan and rotate buttons to examine the area or target you chose. In addition, a Target List window will appear below. This window lists all the targets in the vicinity along with their condition and value. Click on the "+" sign to expand the target list.

Installations displays air fields, air defenses, political installations (such as cities, towns and bridges) and more. You can select as many of these installations as you want by clicking on each option. These selections will display for both North and South Korean units.

Air Units places squadrons, fighters, attack aircraft, bombers, support aircraft (troop and cargo carriers) and helicopters on the map.

Ground Units displays ground units including divisions, brigades, battalions, combat divisions, air defenses and support for both sides.

Naval Units displays combat and supply shipping.

Show Packages displays all packages currently enroute to their designated targets.

Threat Circles let you display radar and ADA (Air Defense Artillery) threat areas on the map. This will allow you to see if your flight plan takes you within known SAMs or AAA (low- or high-altitude) or low- or high-altitude radar coverage. Low altitude represents radar coverage taken at about 5,000 feet; high-altitude radar represents radar coverage area at about 20,000 feet.

Names toggles object names on the map. Any object that has been selected for display with other menu items can also have its name displayed. If Names is turned off, you can still see an object's map label by placing the cursor over the object for a second.

Bullseye toggles displaying the bullseye overlaid on the map. Bullseye is a common reference point used to specify locations. For more information, see the "Bullseye" section in **Chapter 21: The Radar**.



USING INTELLIGENCE

The Mission Briefing window in the Mission Schedule screen and the Intel screen helps you check your mission briefing and enemy intelligence. This is the logical next step after you've reviewed the Planning Map for the selected mission.

Mission Briefing

Click on the Briefing icon to access your mission briefing. This document contains detailed information about the mission, including:

- Mission Overview** Lists the mission name, the specific task (e.g., SEAD strike) and the TOT (Time Over Target).
- Situation** Illustrates the current battlefield situation that calls for your mission.
- Package Elements** Lists all the flights in your package and their callsigns. This information helps you understand all the pieces involved in the mission at hand. Your flight is also highlighted to call it out from the others.
- Threat Analysis** Warns of threats you are likely to encounter, based on the most recent intelligence.
- Steerpoints** Allows you to review your entire flight plan at a glance. Each steerpoint is listed by number along with an action for that steerpoint, such as the time of arrival, heading, speed, altitude and enroute instructions.
- Ordnance** Displays the full ordnance loadouts for each aircraft in your package. You can review what everyone is carrying and decide if your own weapons



load is appropriate for your mission. The Munitions window allows you to change loadouts for your flight only. See the section "Munitions Window"

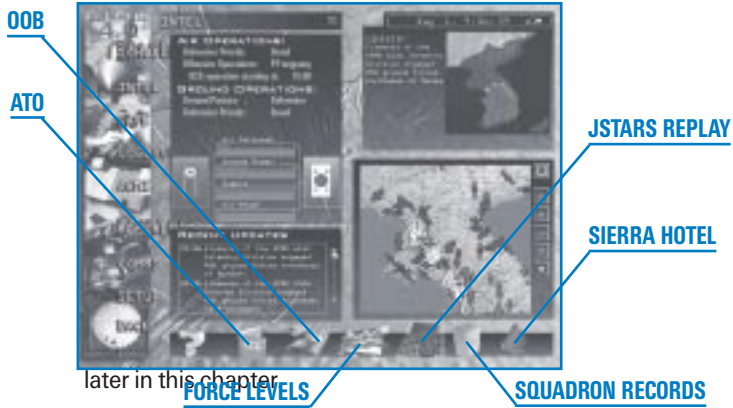

later in this chapter

Weather

Lists the predicted weather conditions for your mission, including wind, temperature, cloud information and the contrail layer.

Rules of Engagement

Describes the strict rules you are required to obey regarding any engagement with the enemy to protect yourself and your allies.

Emergency Procedures

Lists contingency plans in case things go bad. You'll typically have an alternate airbase in your flight plan, in case you run out of fuel or take damage.

The Intel Screen

When you click the Intel menu item on the left side, the Mission Schedule screen is replaced with an Intel screen, which provides an overview of the situation as well as details about the relative strength of forces between North and South Korea.

Two flags representing North and South Korea encompass four bar graphs that show the relative strengths of different asset types. The blue bars represent the strength relative to resource quantity (not quality) of South Korea, and the red bars represent North Korea. To get a

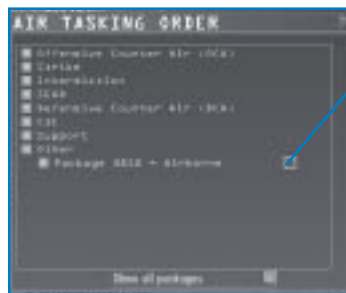

VIEW FLIGHT ROUTE

quick overview of the status of the war, select an asset for each bar group. Click on the headings of each group and choose the asset you want information about.



At the bottom of the Intel display area is a scrolling list of updates from the war that is raging as you plan your next mission. This list is updated in real time with the latest items appearing at the top of the list.

After you select Intel, a number of new buttons appear onscreen at the bottom of the window.

ATO

You can see all aircraft tasked in the entire theater of operations in the Air Tasking Order window.

Your route stays on the planning map in white. Click on "Show all packages" to see all the friendly packages in the air campaign. Click on the "+" sign next to the mission you want to view or package number. All flights will appear listing aircraft icons, callsigns, unit numbers and bases. Click on the button to the right of the package number to view the route of flight for a selected package. Steerpoints for the flight plan will turn blue. By viewing the packages, you can see the extraordinary scope of the *Falcon 4.0* air war.

Country	Flag	Insignia
North Korea		
China		
Russia		
South Korea		
U.S.		



OOB

The Order of Battle is a list of armed forces by type, strength and location for the U.S., DPRK (North Korea), ROK (South Korea), China (PRC), Russia (CIS) and Japan. Click on the flag of the desired country across the top of the window to see its assets. When the icons are blue, the information is unavailable; green means the icon has been selected. Click the "+" sign next to a category to view all of its squadrons and airbases for different branches of the military. For each

major power, you can examine force levels of their air force, army or navy, as well as details of that country's objectives.

You can right-click on a unit and view the Recon Window or its status. Click the unit and then the Find button to center that unit's icon on the map and highlight it. The Status button calls up squadron info for squadrons and status info for everything else on the map.

As each country has its own flag, it has a unique insignia (plane markings on the aircraft).

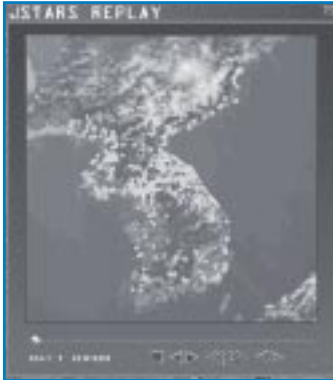

FORCE LEVELS

The Force Levels window provides an overview of each country's air defenses, naval power, supply, fuel, airbases, aircraft and ground vehicles. Force levels are available for the North Korean side (DPRK and potentially PRC and CIS) and the South Korean side (ROK and U.S.). Allied countries are grouped together. This diagram is the easiest way to compare the levels of forces and war supplies for each side over time. North Korea is in red, and South Korea is in blue. Again, this only measures quantity, not quality.

JSTARS REPLAY

Click on the JSTARS icon to view the movement of ground vehicles in the war to date using a VCR-like playback window. JSTARS (Joint Surveillance Target Attack Radar System) is an E-8 aircraft that monitors the ground situation during a war. JSTARS provides target detection and tracking for moving ground targets, providing important targeting information to Air Command. JSTARS does for the ground war what AWACS does for the air war.

JSTARS shows the entire Korean peninsula with major battle action mapped out in red and blue dots. This is an enlargement of the peninsula map. Blue dots represent ROK forces, and red dots represent DPRK forces. You can step through the war one hour at a time using the VCR controls. This is a good way to see the big picture of what has happened to date in the war.



SQUADRON RECORDS

Press this button to display the records for your squadron. The top part of the window lists the type and name of the squadron. It also indicates where it is

based and its role. The bottom of the window alternately displays detailed squadron information or pilot information.

Click the Squadron button to see squadron information. This window includes detailed information on your squadron, including battle statistics and pilot status. Click on the Pilots button to access career totals for each pilot in the squadron. This window also displays the number of kills and mission ratings.

SIERRA HOTEL

Sierra Hotel is where the Sh*t Hot pilots get their proper recognition. The top pilot (the ace of the base) is shown at the top of the list. The rest of the pilots are displayed in a scrolling list, in order of air-to-air kills.



MISSION PLANNING

After reviewing your mission and briefing, you may need to make changes to your flight plan. Comprehensive mission planning tools are part of the Planning Map and the Flight Plan windows. When you select a mission, its flight plan appears on the Planning Map. All route and flight parameters are automatically calculated. You can change these parameters, however, using the menus described below.

STEERPOINT MODIFICATION MENU

Return to the Mission Schedule screen by clicking on Mission Schedule on the left side of the screen. After you expand the Planning Map, right-click on a steerpoint to bring up a new menu that lets you modify your flight plan.

Use the Planning Map to change or lock any of the following elements of a steerpoint:

- Recon** Provides strategic information and a 3-D view of a specific target or location on the terrain. In addition, the Target List window appears.
- Lock Time** Locks the TOS (Time Over Steerpoint) so that it cannot be changed if you change the position or speed of this or other steerpoints. If TOS is locked and you change the position of the steerpoint, the airspeed will be adjusted to allow TOS on the locked steerpoint to remain the same.
- Lock Airspeed** Locks the airspeed so that it isn't modified if you change the position or time of the steerpoint. If airspeed is locked and you move the position of the steerpoint, the TOS setting is adjusted accordingly.
- Climb Mode** Lets you select between immediate and delayed climb modes. Immediate tries to get to the altitude set for the current steerpoint immediately. Delayed will wait until the last minute before starting your climb or descent.



Formation Used primarily for your AI-controlled wingmen. Select from Spread, Wedge, Ladder, Stack, Trail, Res Cell, Box or Arrowhead. See **Chapter 23: Radio Commands** for information on formations.

Enroute Actions Actions you can specify enroute to the selected steerpoint. See “Setting Enroute Actions” in the Flight Plan section below for details.

Action Allows you to set the action at the selected steerpoint. See “Setting Actions” in the Flight Plan section below for details.

Delete Deletes the currently selected steerpoint.



FLIGHT PLAN

Click on the Flight Plan icon at the bottom of the Mission Schedule screen to access the Flight Plan window. You can also display this by left-clicking on any of your steerpoints on the planning map. The Flight Plan window is labeled with the number of your flight package and provides the following options:

Flight List selects the flight you want to modify. If more than one flight is part of your package, you can select and change the route parameters for the other flights in your package.

Setting Steerpoints enables you to change any steerpoint. Use the arrows to cycle through the steerpoint numbers. For each steerpoint, you can change the values of the TOS, the airspeed, the altitude, formation, the enroute action, and general action.

Setting TOS helps you coordinate various components of your package by ensuring that all the important pieces will be in the right place at the right time. To set the TOS, click on the hours, minutes or seconds field (it will turn green to show it's selected). Use the arrows to adjust the time. Setting the TOS automatically locks it and turns the lock icon green. To unlock or relock the TOS, click on the lock icon next to TOS. When the lock is green and closed, the TOS is locked; when the lock is blue and opened, it is unlocked.

Setting Airspeed allows you to set the airspeed for each steerpoint by clicking the arrows. You can change airspeed in increments of 5 knots. Setting airspeed automatically locks airspeed. **Chapter 27: Mission Planning and Execution** has more information on adjusting TOS and airspeed for an entire package

Setting Altitude allows you to set the altitude for the steerpoint.

Setting Climb/Descent allows you to choose whether the climbout to the next steerpoint is immediate or delayed. Select Delayed to remain at the last steerpoint's altitude until just before arriving at the next steerpoint. Select Immediate to climb to the current altitude immediately on arriving at the steerpoint.

Setting Formation tells your wingmen to fly a particular formation. Choose from Spread, Wedge, Ladder, Stack, Trail, Res Cell, Box or Arrowhead. You can find descriptions of these formations in **Chapter 23: Radio Commands**.

Setting Enroute Action sets the actions of your wingmen or the other flights in your package while enroute to a specific steerpoint. Only the available actions will appear in this list. Additional actions are possible for other packages and missions depending on the aircraft type and mission.

Setting Action sets the action of your wingmen or the other flights in your package when they reach a steerpoint. Only the available actions will appear in this list. Many more actions are possible for other packages and missions depending on the aircraft type and mission.



Steerpoint Info displays pertinent information for a particular steerpoint. For example, if the steerpoint is a Takeoff or Land steerpoint, the name of the airbase will appear in this area. When you're displaying the target steerpoint, the Flight Plan window displays a new button labeled Assign at the bottom of the window. Click on the Assign button to access a target list to assign specific targets to the selected flight. The Target List window includes a list of individual targets that you can examine using the Recon feature described earlier.

MUNITIONS WINDOW

If you have already created a package or a flight, click the Munitions icon in the lower right corner. Each option available in the Munitions window is briefly explained below.

Aircraft Tabs

At the top of the Munitions window are up to four tabs, which represent each aircraft in your flight. You can make changes to any or all of the aircraft at the same time. All aircraft are initially selected. If you don't want to change the loadout of a given aircraft, click its tab so that it is not selected. A line under the tab signifies that that aircraft is not selected. You can reselect it by clicking again.



Changes will apply only to the selected aircraft.

3-D Model

A 3-D representation of the aircraft that is being loaded appears in the top half of the window. This model can be rotated and zoomed with the controls to the left.

Aircraft Statistics

The Munitions window dynamically calculates the current loadout weight and drag index of munitions attached to the aircraft. Weight and drag are important factors in all missions because they dramatically affect an F-16's flight characteristics and turning ability. Statistics are available for max weight, gross weight, clean weight, munitions, fuel and drag factor.

For detailed information on using the Munitions window, check out **Chapter 11: Tactical Engagement**. To learn more about different weapons, see **Tactical Reference** in the game.

Munitions Options and Buttons

The Munitions screen includes features for selecting, saving, loading and restoring different loadouts. Remember that you cannot change the loadout of any aircraft in flight.

Loadout List and Inventory lets you select one of the following lists of munitions: Loadout, Air-to-Air, Air-to-Ground, Other (fuel tanks and cameras) and All (your entire weapons inventory available for your aircraft's hardpoints). Your inventory can be High, Medium, Low or Out.

Munitions Scroll Bar allows you to scroll through munitions available for your squadron. Use the scroll bar after selecting the desired category of munitions from the Munitions list.

Save As saves the current weapon loadout. Use this button to save a custom loadout. You can save as many options as you'd like and name them.

Load a saved loadout. When the dialog box opens, highlight the desired loadout by clicking on it in the window. Then click on Load. To load a specific loadout for each squadron pilot, make sure you have only the desired pilot selected in the aircraft tabs at the top of the window before clicking on the Load button.

Restore a modified loadout. If you modify a loadout but then decide the default (computer-selected) loadout is better, click on Restore. Remember that after you modify a loadout and

click on OK, you cannot use Restore to bring back the computer-selected loadout.

Clear completely removes a loadout from the selected pilot. With a clean slate, you can begin building your preferred loadout.

Cancel any changes you've made to your loadout or your squadron during this visit to the Loadout window.

OK accepts the current loadout shown onscreen. This includes any modifications you've made to the default loadout.

Note: Consider saving the original loadout prior to modification by clicking on the Save As button. This will help later when you'd like to return to the computer-configured loadout.

ENTERING THE MISSION

The *Falcon 4.0* Campaign runs in real time. The Event Map on the Mission Schedule screen includes a clock that shows the mission time and the number of days you are into the Campaign. The clock initially starts at on Day 1 and then begins running in real time. When you select a mission, its takeoff time may be much later than the time listed on the Campaign clock. Use the time before a mission to study your briefing, flight plan and the intel situation.

If you are ready to fly, you can speed up time in one of two ways:

- ✦ Click on the clock's drop-down list and select from 2 to 64 times the clock rate. You can also stop time using this drop-down list if your flight is soon and you want more time to study the situation.
- ✦ Click the Commit button in the lower right of the screen. If the Campaign time is not equal to the time of your flight, the sim will accelerate time as quickly as possible to bring you to your flight time.

TAXIWAY VS. RUNWAY TAKEOFF

If you click on the Fly icon before takeoff time, you can choose to appear either on the taxiway or on the runway ready for takeoff.

If you chose Taxi, when the mission loads, you will need to get clearance to taxi. Press **T** (for Tower), then press **4** to request taxi clearance.





If you chose Take Off, you will enter the simulation on the runway, cleared for takeoff.

S CRAMBLE

If attacking aircraft are approaching your airbase while you are briefing or debriefing, a special dialog box appears asking if you want to accept this Scramble mission. If you want to accept this mission, click the Intercept button and you will return to the Mission Schedule window, with you being placed automatically in the intercept flight's lead aircraft slot.

Don't waste time here—you've got less than a minute to get into the air and stop the bombers from destroying your airbase!

SAVING A CAMPAIGN

After you choose a campaign and enter the Mission Schedule window, you can save the campaign by clicking on Save on the left side of the screen. Simply give the currently running campaign a name and click on the Save button.

If you want to access a saved campaign at a later time, simply click on the Saved tab at the top of the Preliminary Campaign window and then click on the campaign you'd like to load. Press the Commit icon in the bottom right corner, and the saved campaign will load.

AUTO SAVE

The Campaign also has an automatic save feature that automatically saves the state of the campaign at three different points:

- ✦ When you click on the Fly icon to enter the simulation
- ✦ When you press **[Esc]** in the simulation and select "End Mission"
- ✦ When you click the Back button to return to the main menu

Falcon 4.0 creates an autosave file named "Auto Save." You can rename this file by clicking on the Save button.

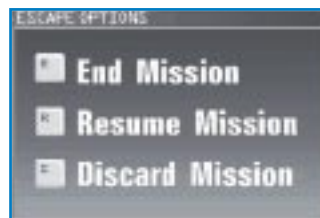

If you press **[Esc]** and discard the mission, you will return to the point in campaign time when you clicked the Fly icon to fly the mission you just ended. In this situation, the campaign will not be saved.

ABORTING A MISSION

If you need to abort a mission while in mid-flight, press **[Esc]** and either select End Mission or Discard Mission. When you press the End Mission option, a Debriefing window will appear with information about your flight. The campaign will record the success or failure of this mission when you decide to exit.

If you do poorly and want to scrub a mission, choose the Discard Mission option. The mission will end and you will be taken back to the Mission Schedule window. The Campaign computer will return you to the point in the campaign just before loading the mission you just aborted. If you need to exit the Campaign entirely, you can either save your mission using the Save menu item or back out by clicking on Back and have *Falcon 4.0* automatically save the campaign.

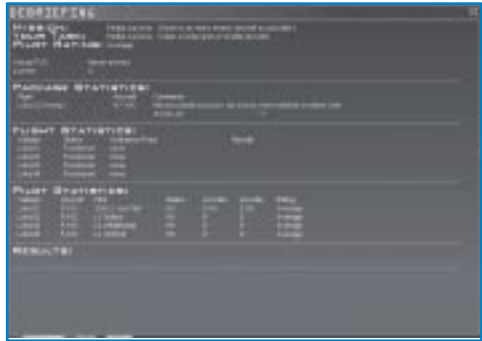

ENDING A MISSION

When you end a mission, either by being killed or by completing the mission, you will return to the Debrief screen, which lists your mission results and rating.

DEBRIEFING

The Debriefing window appears after you exit the mission. The Debriefing window includes critical information on the following topics:

Your task and pilot rating lists whether the mission was successful, partially successful or a failure. This section also lists any losses incurred by your flight and your pilot rating.

Package statistics lists flight names, aircraft used and detailed comments in a drop-down list. This comments section is a log file that records significant events in the mission.

Flight statistics details ordnance used, by callsign. This section also lists the results of all ordnance used (by percentage of targets hit).

Pilot statistics lists statistics for each pilot, including callsign, aircraft type, pilot name, current status, air-to-air kills, air-to-ground kills and rating. Number in parentheses are attributed to the AI pilot (before you jumped into the plane).

Results tells you whether your mission was considered complete or not.

WINNING AND DYING IN A CAMPAIGN

To win a campaign, one of three conditions must be met:

12-25 Capture of key cities

✦ Attrition of forces

CHAPTER

13



LOGBOOK

The Logbook contains all of your personal information, including a record of your entire career in *Falcon 4.0*. You can even add your photo and a personal squadron patch. You'll use the Logbook to identify yourself during online or single play.

Call up the Logbook window by clicking Logbook on the main menu. You can also bring up the Logbook by clicking the name in "Settings for: [name]" in the Setup window.



ADDING A NEW LOGBOOK ENTRY

The Logbook can hold records for more than one pilot. If more than one player is using the same copy of *Falcon 4.0*, each player can have his or her own Logbook entry. To add a new player into the Logbook, click the New button. The player callsign defaults to "Viper" and the player name to "Joe Pilot." You can change these by simply typing in your desired callsign and name.

If you want to start over with a fresh Logbook, click the Clear button. This clears out all pilot information, including career statistics.

If you click Cancel, you'll close the Logbook without recording any changes you might have made. Click OK to close the Logbook with the changes you've made.



THE PILOT INFORMATION

Some pilot information can be entered or changed by the pilot, such as the callsign. The Logbook also records information about your career that you cannot change manually. This information is based on the missions you fly and the successes (or failures) you achieve.

PILOT PICTURE

At the upper left of the Logbook is a place for your picture. Click the Picture area to choose from a variety of pilot photos. The filenames are designated with “M” for male or “F” for female, followed by “W” for white, “B” for black, “A” for Asian, “H” for Hispanic, “AI” for American Indian or “ME” for Middle Eastern. The following number denotes the age group with “1” for ages 24–29, “2” for ages 30–32 and “3” for ages 33–40. The last number is simply an ID number for that particular category.

To use your own picture, place the graphics file into the `\FALCON4\PICTURES` folder on your hard drive. The picture must be in either 16-bit Targa (.TGA extension) or 16-bit GIF format with dimensions of 144 pixels high by 110 pixels wide. Your picture can be smaller than this, but the width must be an even number of pixels. If you want to make part of the picture’s background transparent (that is, a mask), make that part of the picture magenta (RGB value 255, 0, 255). That part of the picture won’t be drawn against the background. Once you have copied your picture to the hard drive, go into the Logbook and click the Picture area to select your photo.

CALLSIGN

The callsign field indicates whose Logbook is currently open. If your Logbook is not open, click the callsign list box and choose your own callsign. If you are creating a new Logbook, type your callsign in the callsign field.

PILOT

This field is filled in automatically when you open an existing Logbook. If you are creating a new Logbook entry, type your real name here.

PASSWORD

This field holds a password to keep access to your Logbook private. If you create a password for your Logbook, anyone selecting your callsign from the callsign list box will be required to enter the password before the Logbook becomes active. To create a password, type it into the field. The actual characters are replaced by asterisks. When you click the OK button in the Logbook window, you will be asked to verify your password.

VOICE

Select your pilot voice from this box.

PERSONAL DATA

This area is used to enter any personal data about yourself, such as your e-mail address, IP address, phone number, etc. This information can be seen by other online players and can be changed at any time.

SQUADRON PATCH AND NAME

In the lower right corner of the Logbook is a place for your squadron patch and name. Your squadron patch represents your virtual squadron, not your squadron in the Campaign.

You can personalize this patch in the same way as your pilot picture. The patch must be in 16-bit Targa (.TGA extension) or in 16-bit GIF format with the dimensions of 96 pixels by 96 pixels. The patch artwork should be placed in the \FALCON4\PATCHES folder. Click the Squadron Patch area to load a selected squadron patch. Your squadron name will default to the filename for your patch, minus the extension. So if the squadron patch file is "209TH VFS.TGA," your default squadron name will be "209th VFS." You can edit this name after you load the patch.

RANK

Your rank is earned in Campaign missions based on your flight hours and mission performance. Rank is displayed as a rank insignia.

2nd Lieutenant	1 gold bar
1st Lieutenant	1 silver bar
Captain	2 silver bars
Major	Gold oak leaf
Lt. Colonel	Silver oak leaf
Colonel	Eagle





CAREER STATISTICS

These statistics are cumulative for the duration of your career.

Commissioned

The date your Logbook entry was created.

Flight Hours

The number of hours you have spent “in the air.” This number is cumulative and includes all hours flown in *Falcon 4.0*.

Ace Factor

A numerical rating based on online combat with other humans only, similar to a chess ranking. Other online pilots can look at your Ace Factor to get an idea of how good you are. Fighting against AI (computer-controlled) pilots does not count in the Ace Factor score. Since the lowest rating is 1.0, your Ace Factor will remain 1.0 if you never fight online.

CAMPAIGN STATISTICS

These statistics are specific to your performance in the Campaign.

Campaigns

The three numbers represent your results in the campaigns. The first number shows the number of campaigns you have won, the second represents the number of campaigns you have lost, and the third is the number of your campaigns that resulted in a draw or stalemate.

Missions

The number of missions you have flown. To get credit for a mission, you must fly at least from the point of joining a package to the point where your package reenters friendly territory. This number is cumulative for all missions flown in all campaigns.

Rating

Your average rating for all the missions you have received credit for. For each mission you fly, you’ll be rated from 1 to 5, with 5 being the best. Not landing will lower your mission rating.

Kill Ratio

Your Campaign kill ratio. This indicates the ratio of kills you have made to the number of times you have been killed. When you are killed in a mission, your records under that pilot name won’t vanish. You are simply “reborn” with the same record information—although your kill ratio changes.

Online

Your online kill ratio. This represents the ratio of the number of kills you have made against human pilots to the number of times you have been killed by human pilots.

A-A Kills

The cumulative number of your air-to-air kills in all Campaign play.

A-G Kills

The cumulative number of your air-to-ground kills in all Campaign play.

Static

The cumulative number of kills of static targets, such as buildings, runways, etc.

Naval

The number of Campaign ship kills you have accumulated.

Deaths

The number of times you have been killed during the Campaigns, either online or offline.

DOG FIGHT STATISTICS

The Dogfight statistics measure your performance in the Dogfight arena.

Games Played

The total number of Dogfight missions you have flown.

Won/Lost

The number of dogfights you have won and the number you have lost.

Online

The number of your wins and losses in online dogfights.

Kill Ratio

The ratio of the number of times you have made a kill to the number of times you have been killed in a dogfight.

Online

A similar kill ratio, but it represents your kills and deaths online against other human players.



MEDALS

As you fly Campaign missions, you will earn medals, awarded upon the successful completion of your missions and for outstanding achievements. These medals appear in the Medals panel of the Logbook.

The Air Force Cross is awarded for tremendous heroics. It may be given to any person serving with the U.S. Air Force when engaged in action with an enemy of the United States or when serving in conjunction with allied forces engaging opposing foreign forces.

The Silver Star is awarded to any member of the U.S. Armed Forces for gallantry when engaged in action with an enemy of the United States or when serving in conjunction with allied forces engaging opposing foreign forces.

The Distinguished Flying Cross is awarded to any member of the U.S. Armed Forces who has distinguished himself or herself by "heroism or extraordinary achievement while participating in an aerial flight." The requirements for this award do not include the engagement of enemy forces.

The Air Medal is awarded to a member of any branch of the U.S. Armed Forces for meritorious achievement while in active flight. This award is given for both combat and non-combat actions.

The Air Force Longevity Service Award is awarded after you have survived 100 consecutive campaign missions.

The Korean Campaign Medal is awarded for a successful Korean campaign.

If you earn a medal more than once, it will be designated by a cluster or a star on the first medal. The oak leaf clusters are given for medals awarded for personal bravery or achievement, whereas the stars are given specifically for earning multiples of the Korean Campaign Medal. The bronze oak leaf cluster or bronze star indicates one extra medal, and the silver oak leaf cluster or silver star indicates five extra medals.

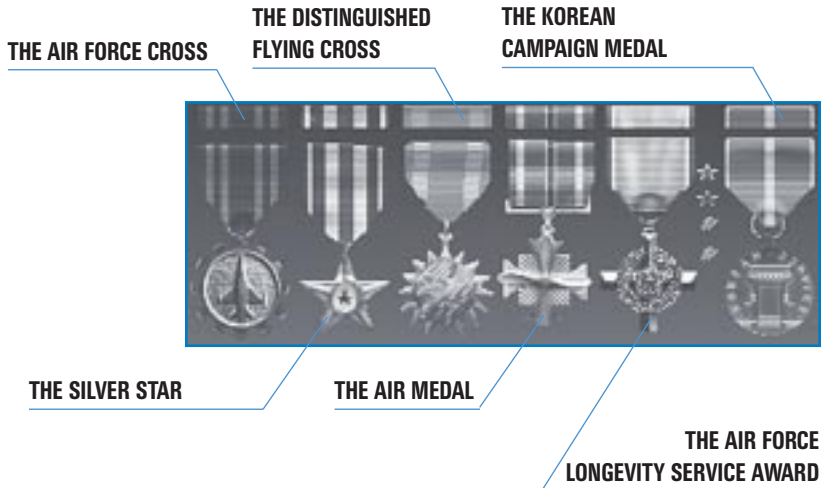

CHAPTER

14



ACMI

Air combat has often been described as “hours of boredom punctuated by moments of sheer terror.” In those moments of terror, it is sometimes hard to perceive or remember all that happens. However, your job as a fighter pilot is to learn from your mistakes and the mistakes of others. The best way to do this is to record and review your mission with the ACMI (Air Combat Maneuvering Instrumentation) system. ACMI records everything that goes on in the area of your aircraft so you can review the action afterwards from many different perspectives.

Be sure to experiment with the different possibilities available in the ACMI. You’ll find a wide variety of ways to analyze a session tape.

HOW TO RECORD IN ACMI

ACMI doesn’t automatically record flight data when you fly a mission. On the right console, you’ll see a switch labeled AVTR (Airborne Video Tape Recorder). To start recording, flip it to the On position. You can also press **[F]** to toggle recording. Once you start recording, you’ll see the word “Recording” at the top of the screen to let you know that ACMI is on. Beneath “Recording” is the tape indicator—a dashed line which shows how much tape is remaining. As the tape starts to fill, the dashes turn to pluses. When the entire line is filled with pluses, the tape is full. At this point, the ACMI will start recording to a new tape.

When you turn off ACMI, the word “Recording” and the tape indicator disappear.

ACMI data is recorded directly to your hard drive. You can set the maximum ACMI file size in the Setup screen. ACMI taping takes about 100K per minute of recording.

It is a good idea to turn on ACMI when you are in combat or bombing and turn it off during the more mundane parts of your mission. Then you won’t have to wade through the “hours of boredom” and can go right to the “moments of sheer terror” when you review your tapes.

HOW TO REVIEW YOUR ACMI TAPE

Once you’ve recorded data through ACMI, you can review it after any mission. From the main menu, click ACMI. You’ll see a dialog box that lists all of your ACMI tapes. Select one and click Load.

The ACMI review screen will appear. The upper part of this screen displays the recorded flight information and the lower part of the screen holds the controls and events list.

You can load other tapes at any time by clicking the Load button. You can also change the name of an ACMI tape by clicking the Save button and saving it under a different name.

Note that ACMI does not support either sound or 3-D graphics acceleration during playback.



ACMI CONTROLS

The ACMI controls, at the bottom of the ACMI window, are divided into several subgroups.

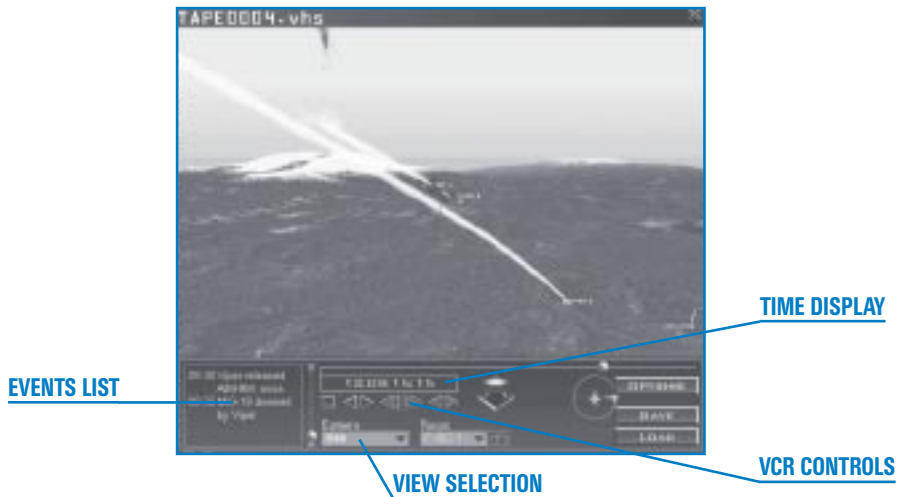

EVENTS LIST

This list describes the major events that took place during the recording of the tape along with their time stamp. By scrolling through this list, you can quickly identify events you want to review and their associated times.

VCR CONTROLS AND TIME DISPLAY

The VCR controls let you move the tape forward and back. If you leave the cursor over most of the controls, tool tip labels will appear.

Progress scroll bar Indicates the relative position of the current scene within the entire tape. The ball moves across the bar as the tape is played, and the events list scrolls automatically. You can also drag the ball to any place along the bar to quickly move to a new position in the tape.

Time display	Indicates the time of the current display. It uses the same time frame as the events list.
Stop button	Stops the tape.
Reverse button	Plays the tape in reverse.
Forward button	Plays the tape at normal speed.
Fast reverse button	Plays the tape backwards at several times the normal rate.
Fast forward button	Plays the tape forwards at several times the normal rate.
Single step back button	Steps backwards through the tape one frame at a time.
Single step forward button	Steps forward through the tape one frame at a time.

VIEW SELECTION

Choose your playback view from three lists. From the Camera view list, select Internal, Orbit, Chase, Satellite, Isometric, Free or Tracking. Choose which aircraft to follow from the Focus list. If you chose the Tracking camera view, select which object you want to track from the Track list.

Camera

Use this list to select the camera view you want for your ACMI playback. This list gives you a variety of options to select *where* you are looking from. The Focus list, described below, lets you decide *what* you are looking at. We'll describe the camera views in relationship to aircraft, but the Focus list will let you choose various objects, including aircraft, missiles, bombs and ground units.

INTERNAL

The Internal view is the view from inside the cockpit. A rectangle is drawn on the screen to indicate the HUD. In the upper left corner of this rectangle, you'll see the aircraft's designation, speed, altitude and heading.

ORBIT

The Orbit view places you outside the aircraft, and you may zoom in or out and rotate your view in any direction. When you select this camera, the zoom and rotate controls appear.

CHASE

The Chase view places you outside and behind the aircraft. As the aircraft maneuvers, the Chase view lags slightly but stays behind the aircraft. You can zoom in and out, but you cannot rotate the view.



SATELLITE

The Satellite view places you directly above the aircraft. Since you are fairly high, you can see a lot of the action. You can zoom in and out, but rotation is restricted.

ISOMETRIC

The Isometric view provides a three-quarters oblique view, granting a good overhead perspective that takes in many aircraft.

FREE

This camera places you in space, but you are not connected to any aircraft. You can maneuver freely through space along three axes. Three movement controls appear: horizontal, vertical and rotational. The horizontal control has four arrows indicating four directions of movement, but you can also move along the diagonals. The vertical control raises and lowers your altitude. The rotate control allows you to alter the rotation of your movement.

The view from the Free camera is very interesting when you place yourself at ground zero of a ground attack. You can also use it to position yourself in space at a point where you can analyze spatial relationships. Turning on wing trails (see below) helps show how aircraft moved in relationship to one other.

TRACKING

This view places two objects in the scene together. One is the object that is selected as the focus (see below). This object is placed at the center of the screen. The second object is selected from the Track drop-down list, which appears when you select Tracking in the Camera list.

The idea of this feature is to watch two objects in relationship to each other. For example, if you are in a dogfight with a MiG-21, it is very useful to play back the session keeping both yourself and the MiG in view at all times. The tracking feature allows this.

In this case, select your F-16 as the focus. Select Tracking for the camera. Select "MiG-21" in the Track list. This puts your aircraft in the center of the screen and also always keeps the MiG-21 in view at all times. When used in combination with Wing Trails and other options (see below under "Options"), Track view makes it very easy to understand the dynamic between two aircraft engaged in air-to-air combat.

Focus

This drop-down list displays all the aircraft, missiles, bombs and ground units in the player bubble. When there is more than one of the same kind of object, they are distinguished by a numeric suffix. For example, two F-16s would be listed as "F-16 1" and "F-16 2." You are always the first F-16 in the list: "F-16 1."

When you select an object from this list, it becomes the focus of the current ACMI camera. If you select a bomb or missile that hasn't been fired or dropped, the focus is placed in space at the point that bomb or missile is (will be) released.

Use this list to determine which object you want to look at during playback. For example, if you select a MiG-29 from the Focus list and the Camera view is set to Internal, you'll be looking out the HUD of the MiG-29. If the camera view is set to Chase, you'll be outside the MiG following it from behind. Whichever object is selected in the Focus list is the one that the Camera looks at.

The list has two small arrows that you can use to step through the object list sequentially.

Track

This drop-down list appears when you select Tracking in the Camera list. Use the Track list to select the second object to track in relationship to your primary focus. The camera looks primarily at the object selected in the Focus list, but also keeps the object selected in the Track list on the screen at the same time.

VIEW MANIPULATION CONTROLS

These controls allow you to manipulate the views for various cameras. Not all controls will be available for every camera.

Zoom and Horizontal

ACMI has two sets of controls, only one of which will ever appear at one time. The zoom control allows you to zoom in and out on the current object of focus. The horizontal control lets you move in any direction along the horizontal plane. Although the horizontal control displays four arrows, you can also select the diagonals.

When you click one of the arrows for these controls, you are moving the *camera* that is viewing the scene closer, further away, left, right, etc. The farther you drag the mouse away from these controls, the faster the movement occurs.

You'll see the zoom control for the Orbit, Chase, Satellite and Tracking cameras. You'll get the horizontal control for the Isometric and Free cameras.

Vertical

The vertical control allows you to move up or down in the world. It appears with the Isometric and Free cameras.

Orbit Vehicle

This rotation control allows you to vary the pitch and yaw of the view. This control gives you visual feedback as to how it is rotating the scene. This rotation control appears in the Orbit, Chase, Satellite, Isometric and Free camera views. Note, however, that you only have limited rotational control in the Chase, Satellite and Isometric views.



OPTIONS

You have many options for displaying additional information during the playback of an ACMI session. Click the Options button to get the list.

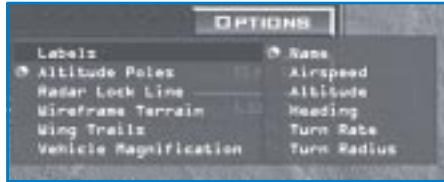

Labels

This item provides a right-hand pop-up menu that allows you to toggle a number of identifying labels for all aircraft (although not for helicopters).

Name	An identifying name for all aircraft and ground vehicles
Airspeed	Airspeed of aircraft in knots
Altitude	Altitude above sea level in feet
Heading	Aircraft heading in degrees
Turn Rate	Turn rate in degrees per second
Turn Radius	Turn radius in feet

Altitude Poles

This option toggles the altitude poles, which are blue lines drawn vertically from the earth to the center of the aircraft. Altitude poles make it easy to quickly judge the relative altitudes of several aircraft at once. They also provide an absolute orientation toward the earth.

Radar Lock Line

When this option is toggled on, you'll see which aircraft are locked up by radar and which aircraft are locking them. When your F-16 has locked up another aircraft, the lock line (which is drawn from your aircraft to the locked aircraft) is white. The locked aircraft also has a white target designator box drawn around it.

If another aircraft has locked up your F-16, the lock line is drawn in yellow and your F-16 will have a yellow target designator box drawn on it.

Wireframe Terrain

You can draw the terrain in wireframe. This can make it easier to see individual aircraft and ground units because they are not lost in the ground clutter.

Wing Trails

This option adds colored trails from the wings of all aircraft. These are like the smoke streamers used by exhibition aircraft at flight shows. The trails are green for the right wing and red for the left wing. This lets you see the “history” of the aircraft’s movement through space. There are five options for wing trails: none, short, medium, long or maximum. The longer the trails, the more “history” they show.

Vehicle Magnification

Select the magnification of air and ground vehicles with this menu. If you want everything to appear their actual size, choose x1. Other magnifications are x2, x4, x8 and x16.

HOW TO DELETE AN ACMI FILE

To delete an ACMI file, open the folder C:\FALCON4\CAMPAIGN\SAVE\ from your Windows desktop. Select the file you wish to delete (*.ACM) and press the **Del** key.

SCREEN SHOTS

In addition to recording with ACMI, you can also take screen shots while in the simulation by pressing **Print Screen**. The screen shots will be located in the default *Falcon 4.0* directory and named with the date and time (for example, “09_08_1998-15_10_16.RAW”). These RAW files can be opened with various graphics programs, such as Photoshop. Be sure to specify the screen resolution and bit depth (24 bits per pixel or 3 channels, interleaved at 8 bit depth).

CHAPTER

15



***TACTICAL
REFERENCE***

One of the best pieces of combat advice is “Know your enemy.” Mission briefings will help you out, but the clever warrior seeks a detailed understanding of the enemy’s aircraft, ground units and weapons. We have built an online reference library into *Falcon 4.0* that contains this valuable information. The Tactical Reference contains detailed data not only about enemy assets but also about allied resources. You’ll find specs, descriptions, pictures and high-resolution 3-D models of every aircraft, ground unit, weapon, jamming device and store found in *Falcon 4.0*.

Bring up the Tactical Reference window by clicking Tactical Reference in the main menu.



CATEGORY TABS

Across the top of the window are two rows of tabs. Use the top row of tabs to select a general category: Aircraft, Vehicles or Munitions. Once you select a category, the second row lists the available subcategories.

Category	Subcategory
Aircraft	Fighters, Attack, Bombers, Helicopters, EW (Electronic Warfare), Support
Vehicles	Tanks, IFV (Infantry Fighting Vehicle), Artillery, Air Defense, Support, Ships
Munitions	A-A (Air-to-Air) Missiles, A-G (Air-to-Ground) Missiles, ARMs (Anti-Radiation Missiles), Bombs, Stores, Surface



SPECIFICATION PANEL

The Specification panel on the left side of the window lists the basic specifications for each asset. Above the Specification panel is a drop-down list that lists all the assets in the selected subcategory. When you select an entry, its specifications appear under several headings. Click the plus marks to expand and the minus marks to collapse the specifications.

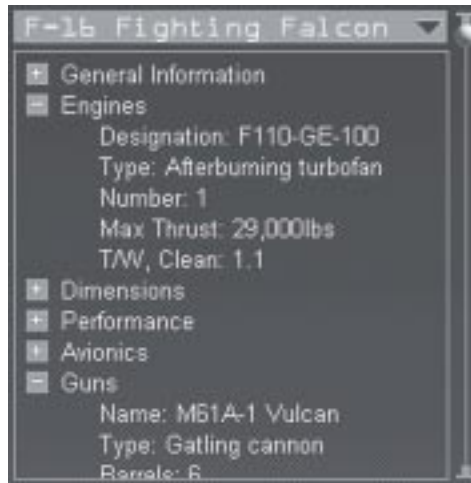

ENTRY DESCRIPTION

Below the Specification panel is the description. This scrolling area displays detailed information about each selected item.

3-D MODEL DISPLAY

To the right of the Specification panel is the 3-D Model Display, which contains a high-resolution 3-D model. You can rotate this object with the rotation control and zoom in or out with the zoom arrows. This display gives you a view of how the object is depicted in *Falcon 4.0*.

OBJECT PHOTO AND RWR PANEL

Below the 3-D Model Display is a real-world photograph of the object. You can see how closely the *Falcon 4.0* objects are modeled after the real things. If the vehicle has radar, you'll see the RWR (Radar Warning Receiver) panel next to the photograph. This panel displays the RWR indicators for the types of radar used by aircraft, ships, AAA units, etc.

In addition, you can click on the RWR Tone button to listen to the demodulated signal from the selected radar. The tone will be identical to what you will hear from your F-16's RWR. If a platform has more than one type of radar system, select the radar you want from the drop-down list above the RWR.



CHAPTER

16



SETUP

Since *Falcon 4.0* is a complex military flight simulator of great depth, we've provided a large selection of configuration options.

You get to the setup screens by clicking Setup in the main menu. The Setup window has four tabs across the top: Simulation, Graphics, Sound and Controllers. At the bottom of the screen are three buttons and a pilot name for whom the settings apply. Since you can have more than one pilot in the Logbook, you can also have individual settings for each pilot. Click on the name after the words "Settings for:" to bring up the Logbook so you can switch pilots.

Apply saves all the settings you have made in all the Setup screens for the current pilot. Cancel will close the Setup window and discard all setup changes that have been made since you last clicked the Apply button. OK applies all the changes and then closes the Setup window.

SIMULATION

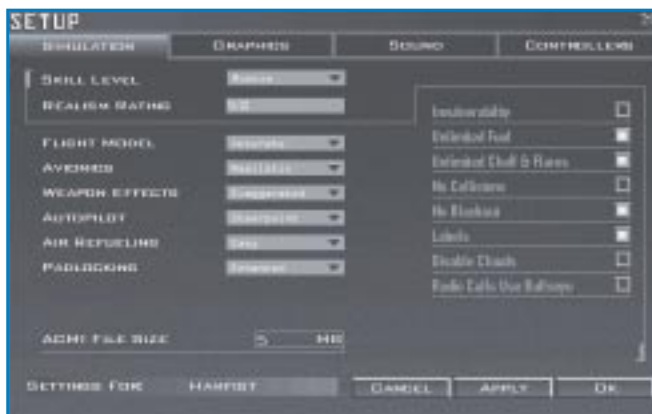

SKILL LEVEL

Choose the skill level from a drop-down list box. Your choices are Ace, Veteran, Rookie, Cadet and Recruit. Choosing one of these skill levels automatically sets various game parameters to match the skill level you choose. Depending on the skill level, other settings will change. You can also modify these individual parameters afterwards.



REALISM RATING

The Realism Rating indicates how realistic your settings are. The range is from 100 (highest) to 0 (lowest). This value is computed automatically according to your other Simulation settings. The Realism Rating is used as a multiplier for your score in Instant Action and as a factor in computing your Ace Factor, which is in the Logbook.

Changing any of the Simulation settings below (except for Disable Clouds and Bullseye) will change the value of the Realism Rating.

FLIGHT MODEL

You can select between two Flight Model settings: Accurate or Simplified. The Accurate setting simulates the real flight model of the F-16, including deep stalls and flat spins. The Simplified setting reduces the forces of drag and is more forgiving at low speed. Your plane also bleeds off less energy while turning, and you accelerate more smoothly. In addition, landings are easier in Simplified mode.

AVIONICS

You can choose from three Avionics modes: Easy, Simplified or Realistic. The Avionics setting applies primarily to the radar, although it also affects your HUD and MFDs. The Easy radar shows every aircraft within range all the time. The Simplified radar only shows aircraft that are in front of you and is closer to the real radar. The Realistic radar simulates the real AN/APG-68 radar and submodes. For more information on the F-16's avionics, read **Chapter 18: The HUD** and **Chapter 21: The Radar**.

WEAPONS EFFECTS

Choose from three Weapons Effects settings: Accurate, Enhanced or Exaggerated. When set to Exaggerated, you don't have to be very accurate with your weapons since the radius of the effect and the magnitude of the damage are exaggerated. Enhanced requires you to be a little more precise. The radius of damage is increased but not as large as with the Exaggerated setting. Accurate requires that you accurately hit the target in order to record a kill. Both the radius of effect and the damage are realistic for the weapon used.

AUTOPILOT

Select one of three Autopilot settings: 3-axis, Steerpoint and Combat. If you choose 3-axis, the autopilot keeps your aircraft flying straight and level at whatever heading and altitude you were at when you engaged the autopilot. 3-axis is the most realistic setting. The Steerpoint setting causes your F-16 to automatically fly to the current steerpoint. When in Steerpoint mode, if you change your steerpoint during flight, the autopilot switches your heading toward the new steerpoint. If Autopilot is set to Combat, the F-16 will actually engage in combat maneuvers all by itself. It will evade attacking aircraft and try to get you into position to shoot down any enemy aircraft. Combat mode will fire weapons automatically if it thinks it can hit its target. In addition, the Combat autopilot will automatically refuel for you as soon as you request refueling from a tanker.

AIR REFUELING

Air refueling requires very precise control of speed and heading. Because this level of precise control varies substantially with different joysticks and throttles, air refueling has three settings: Realistic, Simplified and Easy.

In the Realistic setting, you must get into position without help and you have the longest refueling time—approximately one minute. The refueling boom will help to stabilize the aircraft in position once you are connected.

In the Simplified setting, the boom is more forgiving about position. You only need to fly about 50 feet under the tanker at less than 5 kts closure with the correct basic heading, pitch and attitude and then the boom will “grab” you and bring you into position. Refueling time is shorter than it is for the Difficult mode—about 30 seconds.

In Easy mode, the refueling boom is the most forgiving. You can be within 100 feet at 75 kts closure and then the boom will grab and hold you. Refueling time is the shortest in Easy mode, about 15 seconds.

PADLOCKING

Padlocking is a view that automatically changes as you track a target. This setting applies to both Padlock and Extended FOV views. Choose from three levels of padlocking: Realistic, Enhanced and Disabled.

In the Realistic Padlock setting, you can only padlock targets that are within visual range and are in your current 60° field of view. When you press the Padlock or EFOV key (**4** or **5** key), a yellow TD (Target Designator) box will jump from target to target in the current view only. One second after the last key press, the current view padlocks on the last selected target and the TD box will turn red. Padlock is dropped if the target is blocked by the cockpit frame and does not reappear after four seconds or if the target leaves visual range (approximately 8 nm).

The Enhanced setting allows padlocking of all the targets around you. Each time you press **4** or **5**, the TD box will jump to the next serious threat—but the threat can be in any direction, not just in your current view.

If you prefer not to use padlocking at all, choose “Disabled” from the list.

You’ll find more details about padlocking in **Chapter 22: Views**.

INVULNERABILITY

This setting makes you invulnerable to any damage including ground crashes. Turning Invulnerability on drastically lowers your Realism Rating.



UNLIMITED FUEL

If Unlimited Fuel is checked, you'll never run out of fuel. If unchecked, you have a normal fuel load.

UNLIMITED CHAFF AND FLARES

If Unlimited Chaff and Flares is checked, you can shoot off chaff and flares as often as you like. If unchecked, you have a specific load of 60 chaff bundles and 30 flares.

NO COLLISIONS

If No Collisions is checked, you can run into anything (except the ground) and you won't die. If unchecked, collision detection is on and you will crash if you run into things. This includes other aircraft, buildings and pilots parachuting to the ground.

NO BLACKOUT

If No Blackout is unchecked, you will be subject to the forces of gravity when you pull or push Gs. If you pull enough Gs, your vision will start to narrow until you succumb to GLOC (Gravity-Induced Loss of Consciousness). If you push too many negative Gs, you will burst tiny blood vessels in your eyes and your vision will go red. If No Blackout is checked, you won't notice any visual effects from G forces, although they will still affect the dynamics of your aircraft flight. For more information about blackout, see **Chapter 25: Aerodynamics and G Forces**.

LABELS

When Labels is checked, every military object (planes, ground units, ships) is tagged with its name. This identifier floats just above the object, which is useful for identifying objects. If this is unchecked, you won't see the name labels. See **Chapter 22: The Views** for more information.

DISABLE CLOUDS

Checking the Disable Clouds box turns off the clouds. We recommend disabling clouds unless your 3-D graphics accelerator has at least 4MB for texture memory.

RADIO CALLS USE BULLSEYE

If checked, all radio calls to you are relative to a preset location known as bullseye. The bullseye is located at Kaesong in North Korea. Bullseye information will appear on your radar and HSD screen. If unchecked, radio calls reference the position from your aircraft. See **Chapter 21: The Radar** for more information about bullseye.

ACMI FILE SIZE

This indicates the total size in megabytes of your ACMI recording file. ACMI records all the action as you fly. When the file size is exceeded, the ACMI starts recording on a new tape. You can type in a number indicating the maximum size, in megabytes, for your ACMI file. ACMI uses approximately 200K per minute.

GRAPHICS

The Graphics setup section lets you configure your video card and control the level of detail of the simulation graphics. You will want to modify these primarily to affect performance. The higher the level of detail, the better the game looks—but more demands are made on your computer. Adjust the graphics settings to give yourself the best balance of visual realism and performance.



Next to the check boxes are a set of sliders that let you control graphic detail. Moving a slider to the left gives you a better frame rate but less graphic detail, while moving a slider to the right gives you better graphics but a lower frame rate.

You can preview the results of your Graphics options by clicking the Preview check box. To change your view in the Preview window, hold down the trigger button on your joystick and move the stick.

VIDEO DRIVER

Based on your video card, different video drivers will be displayed in this list box. For example, if you have a Voodoo-based 3-D graphics accelerator, you will see options for Direct3D, Glide, Software, etc. If you do not have a 3-D graphics accelerator, then you will only see Software. Be sure that your video drivers are up to date by checking your video card manufacturer's Web site. For more information about video drivers, refer to the Readme file.

VIDEO CARD

This drop-down list box will display the video card in your system. If you have a 3-D graphics accelerator card, choose it from this list box. Otherwise, choose "Display." For more information about specific video card compatibility, refer to the Readme file.

RESOLUTION

Choose a graphics resolution for the simulation.



TEXTURED OBJECTS

Every object in *Falcon 4.0* has a detailed texture map that is “painted” on the object whenever it is displayed. If you turn off Textured Objects, this texture map is not drawn. Objects won’t look as detailed, but you’ll get better performance.

TEXTURE SMOOTHING

The Texture Smoothing setting smoothes out the ground texture, giving it a more realistic look. This setting should only be used with a 3-D graphics accelerator or if you have a Pentium MMX system; otherwise, performance will suffer significantly.

TRANSPARENCY

The Transparency setting provides transparent smoke when you fire a missile or shoot down an aircraft. This will work without a graphics accelerator card, but it is not recommended.

GOURAUD SHADING

This setting blends the colors of terrain and water. If the Terrain Texture slider is all the way to the right, then Gouraud Shading should be turned off.

HAZE

The Haze setting adds haze to the distance, which gives you realistic depth cueing. This setting also controls the ground fog.

TERRAIN TEXTURE

As you move the slider to the right, you turn on terrain texture. The further to the right you move the slider, the further out the terrain texture is drawn. Moving the slider to the left decreases how far out it is textured. When the slider is all the way to the left, textured terrain is turned off.

TERRAIN DETAIL

The Terrain Detail slider controls both how far out the terrain is drawn and how much detail is used in the closest terrain. As you move the slider to the right, terrain is drawn further out. This reduces the effect of mountains “popping” up suddenly. It also increases the detail of the terrain that is closest to you.

OBJECT DETAIL

Objects are drawn at various levels of detail depending on how far from them you are. If you move the slider to the left, you have to be very close to an object to see it at full detail. If the slider is to the right, the object will be drawn at full detail much further out.

OBJECT DENSITY

Moving the Object Density slider to the right increases the number of ground objects, usually in a city area. Moving the slider to the left will give you fewer ground objects. When the slider is all the way to the left, only the most significant buildings are drawn. This setting affects frame rate significantly, especially in Campaign.

PLAYER BUBBLE

The player bubble is the area around you in which grouped objects are broken out into individual objects. Outside the player bubble, objects (such as a squadron of tanks) are grouped together and acted upon as though they were one object. The larger the player bubble, the more individual objects are available to interact, but greater processing power is required to support them. This setting affects frame rate significantly, especially in Campaign.

VEHICLE MAGNIFICATION

When the Vehicle Magnification slider is to the left, objects are drawn at their actual size. Moving the slider to the right increases their size. Since vehicles can be hard to spot on the ground while flying, setting the magnification to greater than their actual size can help you to find them. This magnification also applies to aircraft and missiles in flight. Increasing the apparent size of vehicles will make them appear to move slower.

SPECIAL EFFECTS

The Special Effects slider controls certain graphic effects are in the simulation: how many, how detailed and how long they last onscreen. Special effects include fire, explosions, smoke, dust clouds, etc.

CANOPY CUES

The Canopy Cues list gives you four choices for visual cues. If Lift Line is selected, arrows are drawn on the top of your cockpit while you're in the 2-D Cockpit, Virtual Cockpit and Padlock views. The lift line cue gives you a frame of reference while you are looking up. The arrows point toward the front of your cockpit (three arrows near the back, two in the middle and one near the front) so you'll always know which way your F-16's nose is. Otherwise, all you'd see is the sky with no sense of which way you're looking.

If you select Reflection, your cockpit will show glare reflection, making it visually realistic but also adding some visual interference. This option is not recommended unless you have a 3-D accelerator card installed.

If you select Both, you'll see both the lift line cue and the cockpit reflection. If Canopy Cues is set to None, neither the lift line cue or the reflections will be drawn.

If you have a 3-D graphics accelerator with only 4MB for texture memory, we recommend that you choose either canopy reflections or the lift line—but not both.



DEFAULTS

The Defaults button under the Preview window sets the Graphics settings to the defaults. If you make changes but then click the Defaults button, the graphics will be restored to their original settings.

RECOMMENDED GRAPHICS SETTINGS

Below are two charts that show which settings we recommend for your system configuration. We feel that these recommendations are the best balance between frame rate and gameplay. Frame rate will depend not only on your CPU, but also your available RAM and video card (which is dependent on video chipset and memory).

Please note that the first table is if you do *not* have a 3-D graphics accelerator. The second table is if you do have a 3-D graphics accelerator (Direct3D or Voodoo-based).

WITHOUT A 3-D GRAPHICS ACCELERATOR

CPU	166MHz Pentium	200MHz Pentium	233MHz Pentium	266MHz Pentium II	333MHz Pentium II	450MHz Pentium II
Resolution	640 x 480	640 x 480	640 x 480	640 x 480	800 x 600	800 x 600
Disable Clouds	On	On	On	On	On	On
Textured Objects	Off	On	On	On	On	On
Texture Smoothing*	Off	Off	Off	Off	Off	Off
Transparency	Off	Off	Off	Off	Off	Off
Gourard Shading	Off	Off	On	On	On	On
Haze	Off	Off	Off	On	On	On
Terrain Texture	1	1	1	2	2	4
Terrain Detail	1	2	2	4	4	6
Object Detail	1	2	2	4	4	5
Object Density	1	2	3	3	3	5
Player Bubble	1	1	1	3	3	4
Special Effects	1	2	2	4	4	5
Canopy Cues	Lift Line	Lift Line	Lift Line	Lift Line	Lift Line	Lift Line

* Can be used on a Pentium MMX system

WITH A 3-D GRAPHICS ACCELERATOR

CPU	166MHz Pentium	200MHz Pentium	233MHz Pentium	266MHz Pentium II	333MHz Pentium II	450MHz Pentium II
Resolution	640 x 480	640 x 480	640 x 480	800 x 600	800 x 600	800 x 600
Disable Clouds	On	On	On	Off	Off	Off
Textured Objects	On	On	On	On	On	On
Texture Smoothing	On	On	On	On	On	On
Transparency	On	On	On	On	On	On
Gourard Shading	On	On	On	On	On	On
Haze	On	On	On	On	On	On
Terrain Texture	1	3	4	4	4	4
Terrain Detail	1	5	6	6	6	7
Object Detail	1	5	5	5	6	7
Object Density	1	3	3	4	5	6
Player Bubble	1	2	2	3	4	7
Special Effects	1	2	3	3	5	6
Canopy Cues	Lift Line	Lift Line	Lift Line	Both	Both	Both

SOUND

There is a lot of audio bombarding an F-16 pilot, and the noise can get overwhelming. The Sound setup lets you balance the volumes of the different sounds.

Each of the following items has a volume slider and a test button. Click the test button to hear the sound and then adjust it using the slider. You can play more than one sound on at the same time.





- Engine** Your basic engine noise.
- Sidewinder** The “growl” your missiles make when they lock onto a heat source.
- RWR** The tones from the radar warning receiver, which lets you know if unfriendly radar units have locked on to you. You can listen to the sounds of specific radars in the Tactical Reference section of *Falcon 4.0*.
- Cockpit** The Voice Message System sounds, warning tones, etc.
- Other Comms** All other communications outside of your flight.
- Flight Comms** Communications to and from your flight.
- Sound Effects** Basic sound effects such as missile explosions and aircraft crashes.

The following two volume levels do not have a test button.

Interface Sounds The feedback the program makes in the user interface.

Music The music used within the program.

In addition, you can control the game’s overall volume level by adjusting the Master Volume slider.

CONTROLLERS

This section lets you set up your joystick and change the keyboard mapping.

GAME CONTROLLER

Joystick

Before starting the game, you must calibrate your joystick, throttle and rudder pedals in the Windows 95 Game Controllers control panel. They must be installed and recognized by Windows 95 in order to work with *Falcon 4.0*. Refer to **The Cadet’s Guide** for more information. If you have more than one joystick attached to your computer, select the one you want to use with *Falcon 4.0* via the drop-down list on this screen.



To verify that your joystick, throttle and rudders are working, move them and watch the graphics on this screen. When you move the joystick, the ball inside the square will move accordingly. The two bars to the right of the joystick square show the movements of the throttle and rudders. Throttle is on the left, rudders are on the right. If either bar is grayed out, then the program does not detect that controller (throttle or rudders).

If you have a joystick that has a digital hat on it, you will see a graphic above the throttle/rudder bars. This graphic will let you verify the four-way movement of the hat. Since Windows 95 does not recognize some older joysticks (such as the ThrustMaster FLCS) as having a hat, you won't see it on the Controllers screen.

To center your joystick, let go of the handle and press the Center button.

You can also test your joystick buttons by pressing them while in the Controllers screen. They will light up in the Joystick Buttons area. Some joysticks don't actually send out button signals for all the buttons but instead generate keystrokes. For these joysticks, all the button lights won't come on. Instead, you'll see the key equivalent appear under the key mapping area (described next).

SPECIFIC JOYSTICK CONFIGURATIONS

We provide configurations for specific joysticks as shown below. The joystick files are installed in the \JOYSTICK directory in the *Falcon 4.0* directory.

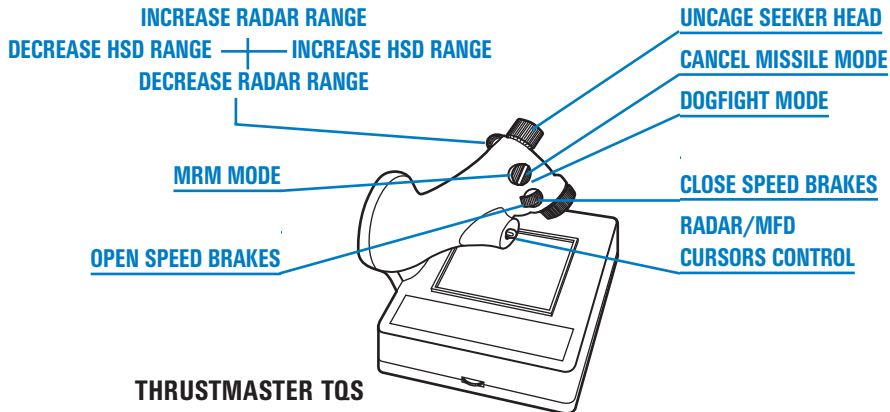
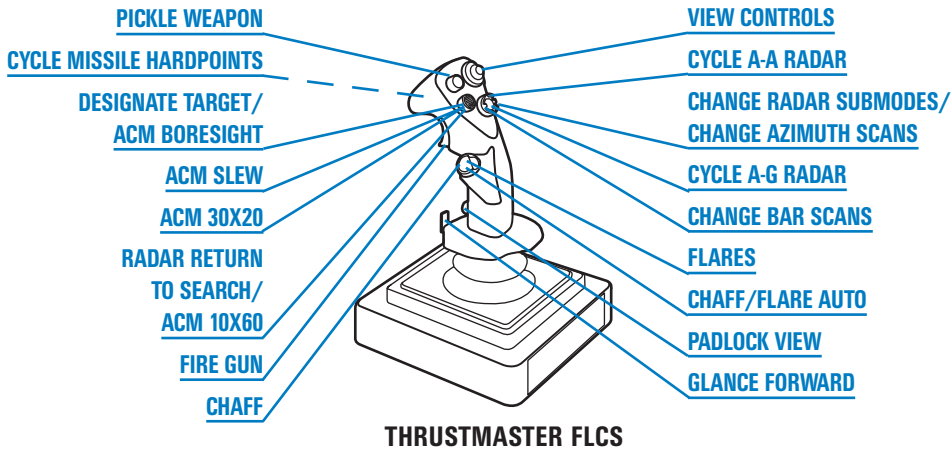

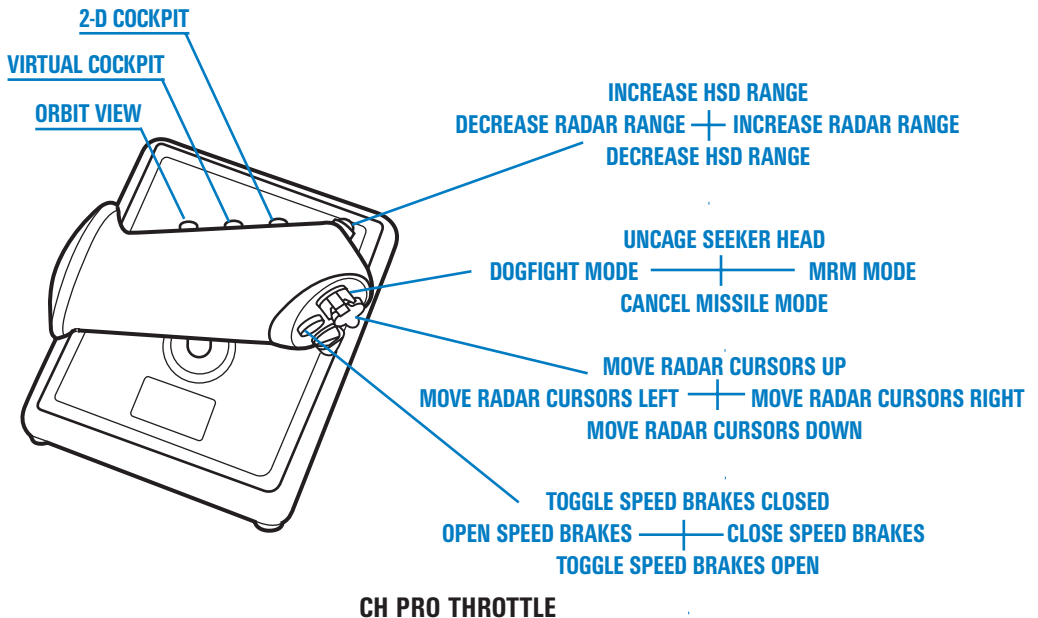
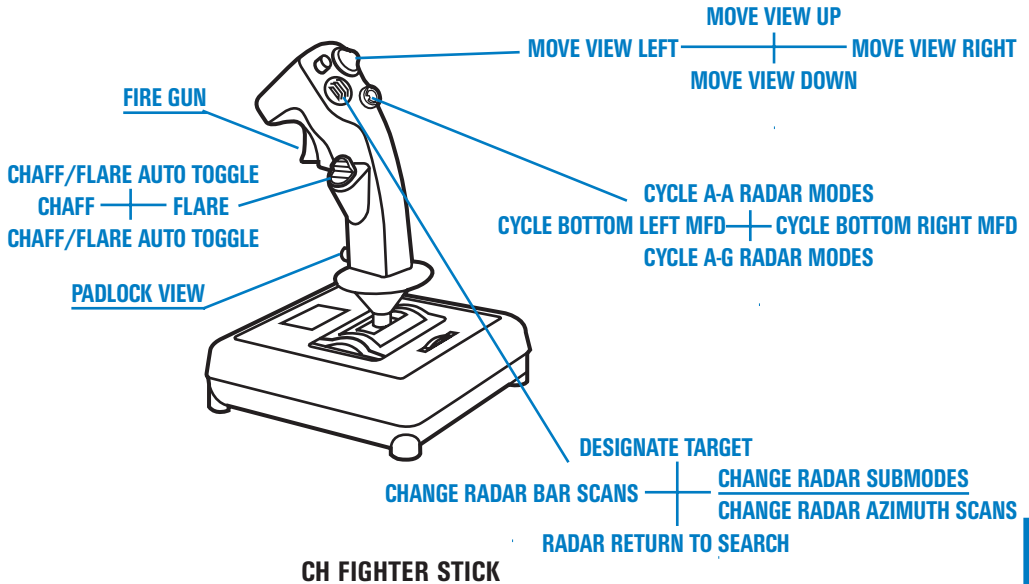

For information on joysticks not listed above, check the Readme file and www.falcon4.com.

KEY MAPPING

Falcon 4.0 uses a large number of keys. Although we provide a default mapping of keys, you can change this mapping if you like.

The keyboard mapping area has two columns of text. The column on the left is the key command, and the column on the right is the description of what the key does. Use the two buttons on the bottom for saving and loading keyboard mapping files. In addition, while in the Controllers setup screen, you can press any key or any joystick button and you'll see the key command appear on the Input line with its description underneath. Pressing a key will also jump the key map list to that key command.

The keys in the scrolling list are grouped according to function. White keys are for single key presses, which includes individual keys and keys with modifiers (such as **Shift**, **Ctrl** and **Alt**). All white keys can be remapped. Keys with a light blue background (such as **Q** for AWACS radio command) cannot be changed.

To change a key mapping, find the function you want the key to represent and click the key that is currently assigned to that function. The key name turns blue. Then press the key you want to map to that function on the keyboard and it will replace the old value.

For example, if you want to change the key for Orbit view from **O** to **5** (which is currently assigned to the Extended FOV view), press **O** to jump to the Orbit view key command. Click on the key command ("O") and it will change color to blue. Now press **5**. The **5** replaces the **O**, and the key mapping for Extended FOV view (which used to be **5**) is now changed to "No Function Assigned." You can't have more than one key assigned to the same function. You can change functions assigned to the joystick or throttle buttons (including the hat) in a similar way.

After you've made changes, you can save them to a file. Use the Save button under the key mapping area.

To load in a previously saved keystrokes file, click Load. You'll get a list of saved keystrokes files. Select the one you want and click Load.

Press OK to save any changes made to the key mapping. This will replace the currently open file. If you use Save and create a new file, this new file will be associated with the current pilot.

PART 3: ***REFERENCE—WEAPONS, AVIONICS, INSTRUMENTS***

CHAPTER 17: THE CONSOLES

CHAPTER 18: THE HUD

CHAPTER 19: THE MFDS

CHAPTER 20: THE ICP AND DED

CHAPTER 21: THE RADAR

CHAPTER 22: THE VIEWS

CHAPTER 23: RADIO COMMANDS

CHAPTER 24: AIRPORT OPERATIONS

CHAPTER 25: AERODYNAMICS AND G FORCES

CHAPTER

17



THE CONSOLES

This chapter describes the switches, gauges and other instruments that you'll find in the F-16 cockpit. The real F-16 has hundreds of switches and displays, and many of them work in *Falcon 4.0*. You must be in the 2-D Cockpit view (2 key) to operate the switches and knobs.

Once you're in the 2-D Cockpit view, to switch to different consoles, press the numeric keypad arrows (↑, ↓, ←, →) or move the mouse cursor to the edge of the screen (you can also use the hat switch on your joystick). When the cursor changes to a green arrow, click the mouse to switch to that cockpit view. The mouse cursor will only appear when you move the mouse and will disappear if the mouse has not been moved for a few seconds.

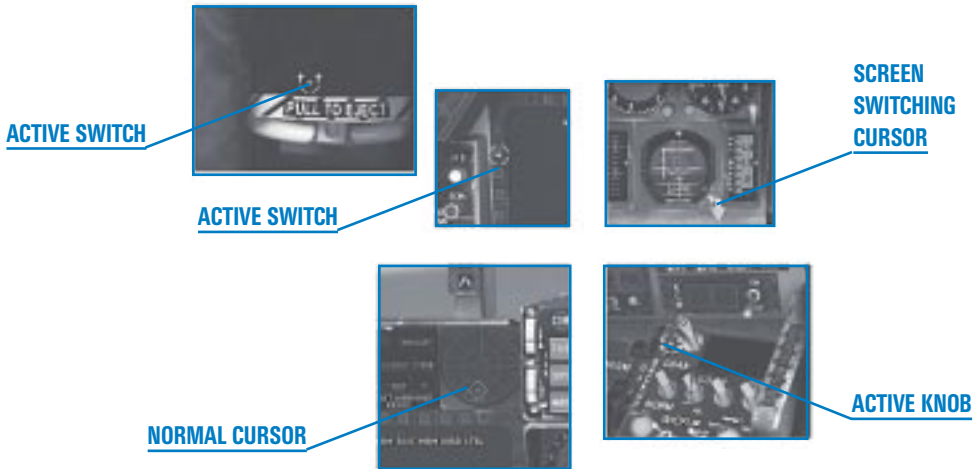

The cursor is normally a red dashed diamond, but when the cursor is placed over an active console item, it will turn green. To operate the switches and knobs in *Falcon 4.0*, place the cursor over the switch or knob. If the cursor is a green dashed circle or "U," you can click the mouse button to flip the switch. If the cursor appears as green circular arrows, click the right and left mouse buttons to turn the knob.



FRONT CONSOLE

The most important instruments are directly in front of you since these are the ones you'll use in combat and navigation.

HUD

The HUD (Head-Up Display) is a special glass upon which important information is projected as you look out the front of the canopy. The HUD is crucial during combat because taking your eyes off the enemy to look down into your cockpit can cost you your life. Because the HUD is so fundamental to flying and fighting, we've devoted the entire next chapter to it.

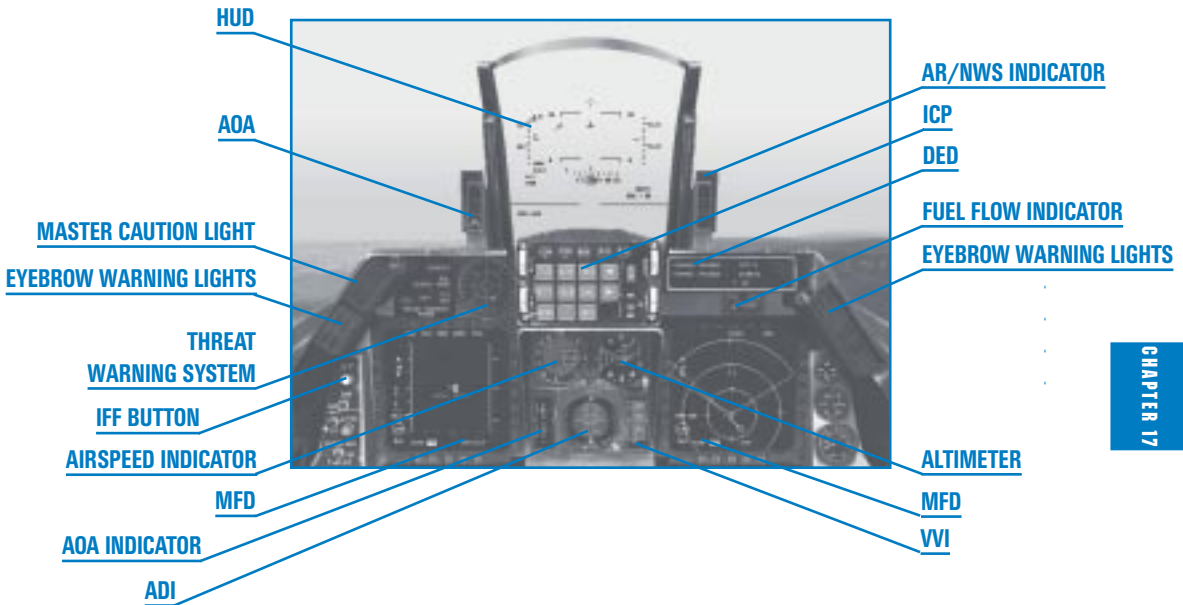

AOA INDEXER

To the left of the HUD are three vertically arranged symbols that comprise the AOA indexer. AOA stands for "angle of attack" (the attitude of your aircraft during flight). Your AOA is particularly important during landing because the nose must be up while you are descending or you will hit the runway too hard. The indexer works all the time, whether the landing gear is up or down.

The AOA indexer visually represents your angle of attack by illuminating its symbols. Use the symbols to adjust your AOA to the proper angle.



When the top red symbol is lit on the AOA indexer, it indicates that your AOA is too high for landing (approximately 15°).

When the center green symbol is lit, your AOA is at 13° and you are on speed with the correct AOA for landing.

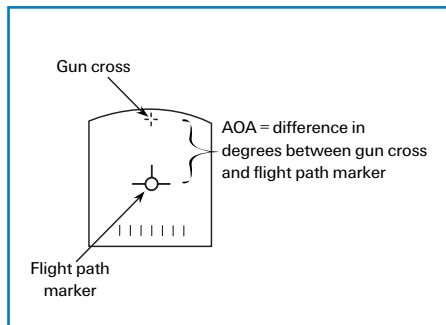

When the bottom amber symbol is lit, your AOA is too low for landing (approximately 11°).

If the top or bottom symbol is lit simultaneously with the middle symbol, this means that your AOA is between these two values.

You can use the AOA indicator (described below) in conjunction with the AOA indexer. In addition, an AOA bracket display appears in the HUD when the landing gear is down.



AR STATUS/NWS INDICATOR

This indicator, located to the right of the HUD, provides status information during air refueling. (How to refuel in midair is described in **Chapter 6: Air-to-Air Refueling.**)



RDY The RDY display illuminates in blue when you are cleared for contact by the tanker.

AR/NWS The air refueling/nosewheel steering display illuminates in green when the refueling boom is latched in place. The NWS light also illuminates when the nose wheel steering system is engaged, which only happens when the aircraft is on the ground.

DISC The DISC display illuminates in amber when the tanker disconnects the boom or you are not flying within parameters.

MASTER CAUTION LIGHT

The Master Caution light usually lights up whenever an individual caution light lights up. It will not illuminate for an eyebrow warning light. Because the Master Caution light is in the front of the cockpit, it is easier to see than the caution lights on the warning panel. When it lights up, be sure to check the warning panel in the lower right console or the Fault Acknowledge (FACK) in the Data Entry Display to see what the problem is. The Master Caution light will also illuminate when you have reached bingo fuel.

Turn off the Master Caution light by clicking it in the cockpit or press **Ctrl**+**C**. It will stay off until another caution light comes on. You should turn the Master Caution light off as soon as the cause is determined so you can monitor the caution lights.



LEFT EYEBROW WARNING LIGHTS

Some lights on the consoles indicate important conditions and are grouped either as eyebrow warning lights or as caution lights. Eyebrow warning lights indicate more serious events that pose immediate life-threatening conditions. Caution lights are less serious and immediate. The warning light below appears on the left front console.



ALT The ALT (Altitude) light comes on when you are below the set ALOW altitude limit. (See **Chapter 20: The ICP and DED** for more information.) When this light comes on, you'll also hear the VMS warning "ALTITUDE-ALTITUDE."

IFF BUTTON

As in the real F-16 Block 50, IFF (Identify Friend or Foe) is not used in *Falcon 4.0* to distinguish friendly from enemy aircraft. To identify aircraft, read about NCTR in **Chapter 21: The Radar**. IFF is limited to identifying yourself to air controllers and is nonfunctional in the game.







THREAT WARNING SYSTEM

The ALR-69 TWS (Threat Warning System) is a passive system that detects radar emissions hitting your aircraft. These emissions can be from other aircraft or from ground units. The ALR-69 registers and processes these emissions and determines the type of radar, the signal strength and the bearing. The TWS consists of the RWR and the threat warning lights.

RWR (Radar Warning Receiver)

The RWR (also known as the azimuth indicator) displays symbols that represent tracking radar signals coming from SAMs, AAA and aircraft radar. The 16 highest priority threats are displayed according to their bearing and radar signal strength. The stronger the radar signal, the closer to the center of the display. The RWR represents a god's-eye view around your aircraft. You are at the center of the circle, and threats appear around the circle in relative bearing to your aircraft.

RWR Symbology	
Search radar	S
Unknown radar	U
Active radar missile	M
Hawk	H
Patriot	P
Naval	
Modern aircraft	
Older aircraft	
Anti-aircraft artillery	A
Surface-to-air missiles	2,3,4,5,6,8,15
Chaparral	C
Launch warning	②
Highest priority target	
Nike/Hercules	N



When your F-16 is inverted, the symbols on the RWR flip left and right to keep a true ground track relationship. They return to normal when the aircraft returns to a non-inverted attitude.

The Tactical Reference in *Falcon 4.0* displays the RWR symbols for all of the radar units you're likely to encounter, along with their threat tones.

Note that if you selected Easy Avionics in the Simulation setup, you will only see enemy targets on the RWR.

Threat Warning Lights

The primary threat warning lights appear to the left of the RWR, while the auxiliary threat warning lights appear on the left console above the manual pitch override switch.

HANDOFF

Press the Handoff button to override which threat is selected. When the button is unlit, the highest priority RWR threat is selected and enclosed in a diamond. Press the Handoff button to select the next highest priority target. You will also hear the corresponding RWR tone for the selected threat. The Handoff button will be lit if the selected target is not the highest priority.

LAUNCH

When the Launch light flashes, it indicates that a missile launch has been detected. You will also hear a high-pitched beeping. The threat warning system can only detect radar-controlled missile launches. It will not detect a heat-seeking missile launch.

PRI MODE

The Priority Mode button determines the priority of the RWR display. When it is lit, the RWR is in priority mode and only the five highest priority threats are displayed. When it is unlit, up to 16 threat symbols may be displayed. Press the Priority Mode button to declutter the display.

NAVAL

Press the Naval button to increase the priority of naval threats. If the button is unlit, naval threats are a lower priority than air or ground threats.

UNK

The Unknown button controls the display of unknown or undetermined radar energy sources. In most cases, the TWS can determine the type of radar. However, if it can't make a determination, it normally doesn't display the source. The default (unlit UNK light) is to ignore unknown radars. However, if you press the UNK button, the unknowns will be displayed on the RWR as "U" symbols. If this button is unlit and an unknown threat is detected, this button will flash.

TGT SEP

Press the Target Separate button to unstack threat symbols that overlap each other on the RWR display. If threats are in the same general orientation to your aircraft, they may overlay each other on the display. Normally the RWR shows all threats at their true azimuth relationship to your

aircraft. If you press TGT SEP, the highest priority threats remain where they are but the lower priority threats are moved radially away from the center. This allows you to see all the threats more easily.

ICP AND DED

The ICP (Integrated Control Panel) sits directly below the HUD and is used for weapons release, landing and navigation, and communications. The DED (Data Entry Display), to the right of the ICP, is used to display systems information. Much of the information that appears on the DED is set in the ICP. The ICP and the DED are described in **Chapter 20: The ICP and DED**.

FUEL FLOW INDICATOR

Located below the DED, the fuel flow indicator shows total fuel flow to the engine, including the use of the afterburner (in pounds per hour). Become familiar with the normal rate of fuel flow as it is used to monitor fuel usage and power settings as well as damage to the fuel system.

RIGHT EYEBROW WARNING LIGHTS

This set of warning lights appears at the far right side of the front console.

FIRE/ENG

The engine fire warning light glows red if there is a fire in your engine. Your only recourse is to eject before your plane explodes.

HYD/OIL

When the hydraulic system and oil pressure light illuminates, it indicates low pressure in the hydraulic systems or low engine oil pressure. If this light comes on, your engine will eventually freeze up, although you may have some time before this happens. If you can set up for a dead stick landing, go for it. Otherwise, try to get yourself as close as possible to friendly territory. If both systems fail, your only option is to eject.

DUAL/CAN

This lamp indicates a problem with either your dual flight control system or your canopy. If your dual flight control system has a problem, two or more of your FLCS computers are off-line and no arbitration is done among them. The result is significantly reduced reliability of your flight control system. Return to base as soon as possible.

T/L CFG

If the takeoff/landing configuration warning light comes on, your configuration is incorrect for takeoff or landing, specifically your landing gear. Make sure your landing gear is down and locked. If your gear is damaged in battle and cannot fully lock down, you will either have to eject or get





very good at belly landings. In addition, the T/L CFG light will come on if you are in a slow, tight turn because the flight computer (based on AOA and airspeed) will think you are landing.

OIL PRESSURE INDICATOR

The oil pressure indicator displays engine oil pressure, ranging from 0 to 100 psi (pounds per square inch). If the pressure drops below 15 psi, you have a serious oil pressure leak. See the information on the hydraulic system and oil pressure warning light above for details on this condition.

NOZZLE POSITION INDICATOR

This indicates the position of the engine nozzle. The indicator will be mostly open at idle, closed at Mil power (100%) and fully open at full afterburner.

RPM INDICATOR

The RPM indicator displays the engine revolutions per minute. RPM is expressed as a percentage from 0% to 100%. 100% is the equivalent of full military power (in which the throttle is at the top detent, before afterburner).

MFDs

The MFDs (Multifunction Displays) are two CRT-based displays located on both sides of the center console. The MFDs are described in detail in **Chapter 19: The MFDs**.

AIRSPEED/MACH INDICATOR

This indicator, below the ICP, shows the current airspeed with the range from 80 to 800 knots. Read the airspeed on the outside dial. The inside dial within the window shows your current speed as a factor of Mach (the speed of sound). Since Mach varies according to altitude, a Mach

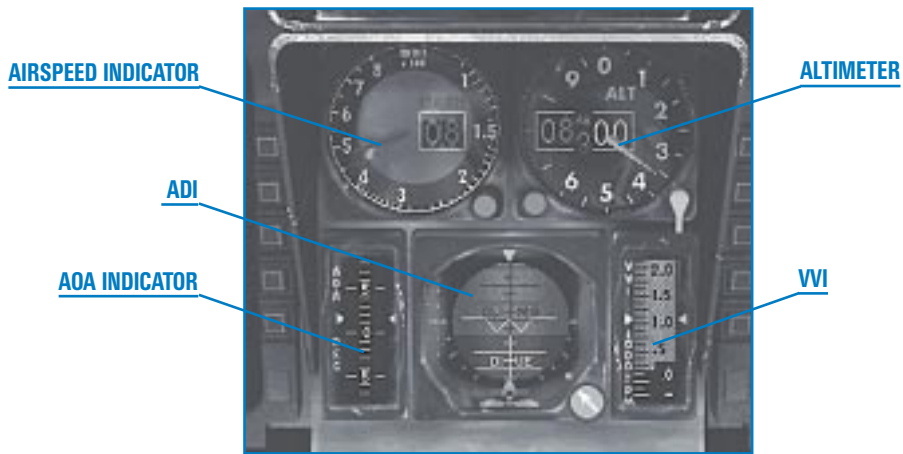

value of 1.0 will not always equal the same calibrated airspeed. This gauge is a backup for your HUD speed indicator.

ALTIMETER

The altimeter displays your altitude above sea level (barometric) which can differ from your altitude above ground level. This gauge is a backup for your HUD altimeter.

AOA INDICATOR

The AOA indicator displays the current angle of attack numerically on a moving tape. The range is $\pm 32^\circ$. The tape is color-coded from 9° to 17° , corresponding to the colors of the AOA indexer.

ATTITUDE DIRECTOR INDICATOR

The ADI (Attitude Director Indicator) displays the pitch and roll of the aircraft. It is divided in the center by a horizon line, with the top half of the ADI in blue (indicating sky) and the bottom half in brown (indicating ground). The dividing line matches the horizon. A waterline is drawn across the ADI to provide a reference to your aircraft's attitude.

In addition, two white ILS bars are overlaid on the ADI corresponding to the glide slope and deviation scales used for ILS. These are backups for the ILS HUD mode. If you are outside the glide slope and deviation limits, the bars will be pinned to either side of the ADI out of sight. The side the localizer bar (the vertical bar) is pinned to indicates the direction of the localizer. The ILS bars only function if you are within 10 nm of the runway. For more information on how to configure the navigation system for the ILS bars to work, see "Navigation System" below.



VERTICAL VELOCITY INDICATOR

The VVI (Vertical Velocity Indicator) is a vertically moving tape indicating your rate of climb or descent in feet per minute. You are descending if the tape is in the black and climbing if the tape is in the white area. The VVI has a range of 6,000 feet per minute. You can also put a vertical velocity display on the HUD in NAV mode if the altitude tape is displayed and the scales switch is set to "VV" in the HUD control panel.

HORIZONTAL SITUATION INDICATOR

The HSI (Horizontal Situation Indicator) is a navigation instrument used primarily as a backup device for more modern navigational systems, such as the HSD (Horizontal Situation Display) and the steerpoint symbols on the HUD. The HSI provides course, heading, bearing and distance information to a TACAN (Tactical Air Navigation), steerpoint, runway location, tanker or markpoint.

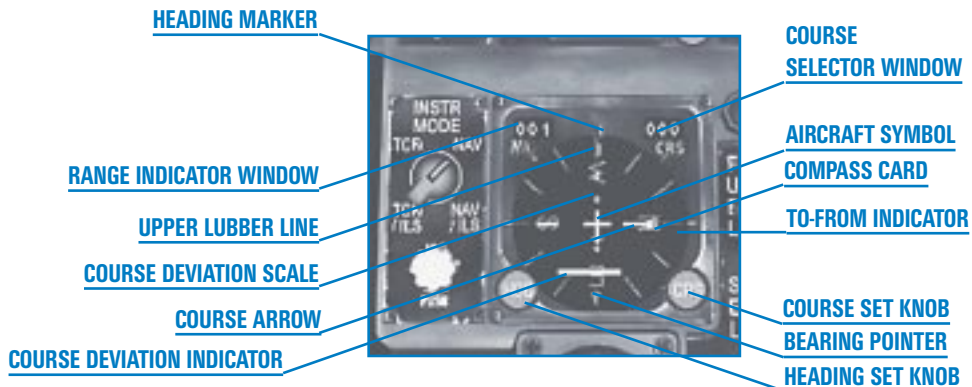

The HSI provides a top-down orientation to navigation. Its display is oriented with your position always in the center, as though you were looking down at the ground from the heavens. Position and direction information is based on a compass dial on the HSI.

The HSI contains the following elements:

- ✦ A compass card, marked in degrees from 0 to 359. It represents your current heading.
- ✦ An aircraft symbol in the center, representing your position.
- ✦ A course arrow, consisting of a yellow head and tail. This is the course you dial in. Once set, it rotates with the compass card.
- ✦ To-From indicator, consisting of an orange triangle. If the indicator is close to the head of the course arrow, you are going to the steerpoint. If the To-From indicator points to the tail of the course arrow, you are moving away from the steerpoint.

- ✦ A course set knob. Use this knob to dial in the course you want which then moves the course arrow.
- ✦ The course selector window. This window displays the dialed-in course in degrees.
- ✦ The course deviation indicator. This shows graphically how much and in which direction you have deviated from your desired course.
- ✦ Course deviation scale. These dots represent 2.5° deviation each, showing the amount of deviation depending on the offset of the course deviation indicator.
- ✦ A range indicator window, which shows distance in nautical miles to the selected steerpoint or TACAN station. The window will have a red flag across it if it has invalid information.
- ✦ The green heading marker. This provides a visual static reference marker for your desired heading.
- ✦ The heading set knob. This rotates the heading marker to the desired location. Once set, the heading marker rotates with the compass card.
- ✦ The bearing pointer, which consists of a red head and a tail. It shows the angle of bearing from where you are to your point of interest. This pointer is automatically set when you select a steerpoint or dial in a TACAN channel.
- ✦ The upper lubber line. This is a reference mark for the compass card and points to the current heading.
- ✦ Course ILS warning flag, which is a yellow square. The course warning flag appears on the course deviation scale if you have an invalid course (usually a moving tanker or ILS signal).

The HSI is used in conjunction with the Instr (Instrument) Mode selector switch. This switch selects between TACAN and NAV data. TACAN data refers to signals generated by TACAN beacons on airbases and tankers. NAV data refers to steerpoints, markpoints and datalink points programmed into your navigation system.

How to Navigate Using the HSI

The best way to understand the HSI is with an example. Let's navigate to Steerpoint 1, which should be programmed into your navigation system. First, set the Instr Mode selector switch to NAV. Then select Steerpoint 1 with the **[S]** and **[Shift][S]** keys. When you select a steerpoint, the bearing pointer is positioned automatically on the compass card. To fly to the current steerpoint, steer the aircraft until the bearing pointer is positioned at the upper lubber line (the tick mark at the 12 o'clock position). Dial in the yellow course arrow so that it corresponds to the bearing pointer. As you turn the CRS knob, the yellow arrow will move around the compass card. This is useful to help you approach a steerpoint from a desired course. The course deviation indicator will



show whether you are on course or not. If it is deflected to one side of the course arrow, you need to steer in that direction until it aligns properly with the course arrow.

If the steerpoint is a runway, press the STPT button on the ICP and set the Instr Mode switch to NAV/ILS to activate the ILS bars on the ADI when you get within 10 nm of the runway. The ILS bars will be pinned to the extremes of the ADI if you are not on approach.

For more information on how to use the navigation system, see “Navigation System” below.

EJECTION HANDLE

When all else fails and you’re about to auger in, reach for the yellow handle. To eject, pull the ejection handle or press and hold **Ctrl** **E** for at least one second.

KNEEBOARD

Strapped to the pilot’s leg, the kneeboard displays either a map or your mission briefing. Switch between the two views by clicking either tab or pressing **Alt** **K**.

The map automatically sizes itself to show all your steerpoints and your current position. If the map cannot be zoomed out far enough, it will center on your position. If you fly off the edge of the map, your position marker will flash. Just switch views to recenter the map. The map displays your steerpoints, current position and divert target area (if any).

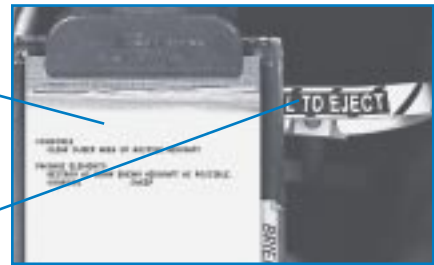

The mission briefing lists your callsign, mission objective, the package objective, your package elements and their objectives.

VOICE MESSAGE SYSTEM

While not actually a console instrument, the VMS (Voice Message System), sometimes referred to as Bitchin’ Betty, provides audio messages and tones which are often played in conjunction with console displays.

If any of the front-mounted red warning lights comes on, you’ll hear the message “WARNING–WARNING (pause) WARNING–WARNING” and the word “WARN” will flash in the HUD. The caution message (“CAUTION–CAUTION”) is automatically activated after any caution light lights up. Turn the warning or caution message off either by pressing the Master Caution light or by fixing the problem.

The voice messages below are played when certain conditions occur.

“PULLUP–PULLUP”

When you hear this message, you’d better pull up because you’re about to collide with the ground. In addition, you’ll see a Break-X in your HUD.

“ALTITUDE–ALTITUDE”

This message occurs when the aircraft altitude is below the ALOW value. ALOW (Altitude Low) is initially set to 300 feet, but you can set it to any altitude. (See **Chapter 20: The ICP and DED** for more information.)

“BINGO–BINGO”

This message will repeat and the words “WARN FUEL” will flash in the HUD when you reach bingo fuel level. Bingo means that you have 1,400 pounds of fuel remaining. The bingo value is reset to half of its current value each time it is reached. For example, bingo occurs again at 700 pounds of fuel remaining, again at 350 pounds and so on. The Fuel Low caution light on the right auxiliary panel will light up when you are down to 750 pounds of fuel.

“LOCK–LOCK”

You’ll hear “LOCK–LOCK” when any ACM radar submode acquires a target. In addition, the HUD will display a target designator box.

Low Speed Warning Tone

This tone is played when the combination of your airspeed and pitch angle presents a dangerous situation. It also sounds if your AOA is greater than 15° during takeoff or landing. Turn this sound off by pressing the horn silencer button on the landing gear console or by pressing **[Alt][G]**.

VMS Priorities

Since more than one message or tone can sound at once, the messages are prioritized. The messages are prioritized in this order:

- ✦ PULLUP
- ✦ ALTITUDE
- ✦ WARNING
- ✦ BINGO
- ✦ CAUTION
- ✦ LOCK
- ✦ Low speed warning tone



LEFT AUXILIARY CONSOLE

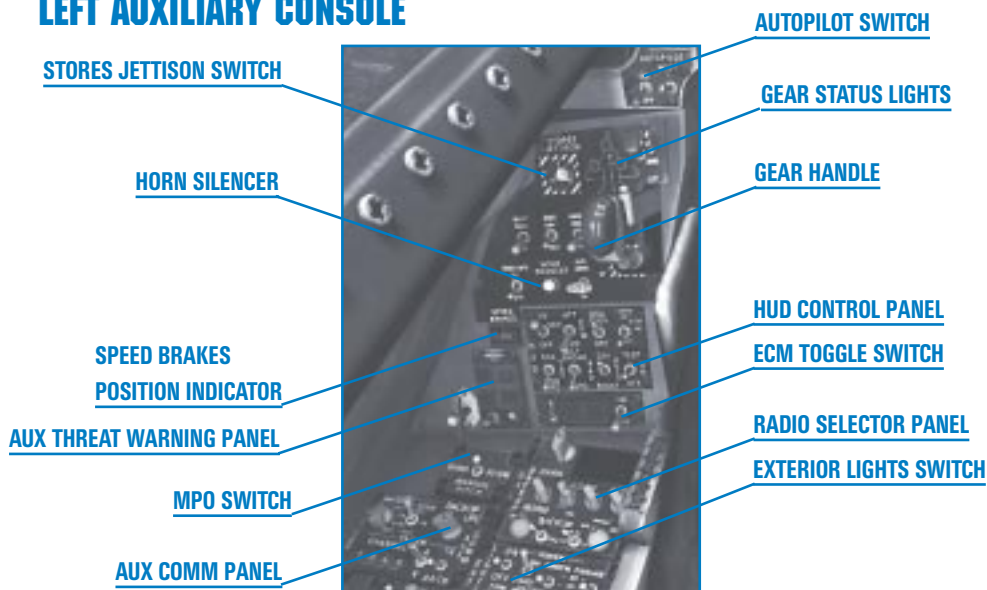

AUTOPILOT TOGGLE SWITCH

This toggle switch turns the autopilot on or off. You can also toggle it by pressing **[A]**. The autopilot mode is selected in the Setup screen. *Falcon 4.0* has three autopilot modes: 3-axis, Steerpoint and Combat.

When you choose 3-axis, the autopilot keeps your aircraft flying straight and level at your current heading and altitude. This is the most realistic setting. If you are in Steerpoint autopilot mode, your F-16 will automatically fly to the current steerpoint. If the autopilot is set to Combat, your F-16 will actually fly and fight by itself. It will evade attacking aircraft, try to get you into position to shoot down any enemy aircraft and will also fire your weapons. The Combat autopilot will also automatically refuel you if you request refueling from a tanker.

EMERGENCY STORES JETTISON BUTTON

Press this button to jettison all stores on your aircraft except for your wingtip AIM-9 missiles. All the weapons are released unarmed, so they won't blow up anything when they hit. Jettison stores only during an emergency.

LANDING GEAR STATUS LIGHTS

These three green lights represent the nose landing gear and the two main landing gear. When the landing gear is down, these lights illuminate in green. When the landing gear is up, these lights are off. You may incur battle damage to one or more gear. In this case, the damaged gear will not show a green light.

LANDING GEAR HANDLE

The landing gear handle determines the position of the landing gear. When the landing gear handle is up, the gear will be in the up position. When the handle is down, the gear will be in the down position. You can manually move this gear handle in the 2-D Front Cockpit view or by pressing **[G]**. As the gear is raised or lowered, the red lamp will light within the landing gear handle. When the landing gear is down, the three green wheels-down lights turn on. They are extinguished when the gear is up.

Do not lower the gear at airspeeds of greater than 300 knots or you will probably damage the landing gear. If the gear is damaged, the green wheels-down lights will flash.

HORN SILENCER BUTTON

The horn silencer button is used to turn off the low speed warning tone. See “Voice Message System” above for more details.

SPEED BRAKES POSITION INDICATOR

This indicator reflects the status of your speed brakes. The indicator can read closed, open or a number from 0.1 to 0.9, indicating the percentage that the speed brakes are open with 0.1 being the smallest amount open and 0.9 being almost fully open.

When the speed brakes are open, you’ll hear the wind as they produce significant air resistance. Use this audio cue as a way of telling if your speed brakes are open.

HUD CONTROL PANEL

The HUD control panel determines how the HUD displays information.

Scales Switch

This switch controls the selection of various HUD scales.

The VV (Vertical Velocity) position turns on the vertical velocity scale, the altitude scale and the heading scale. The velocity and altitude tapes displayed in HUD mode.

The VAH position turns on the velocity scale (but not the vertical velocity scale) in HUD mode.

The Off position removes the heading digital readouts instead of tapes.

Toggle between the tapes and the discrete displays by pressing **[OFF]**.

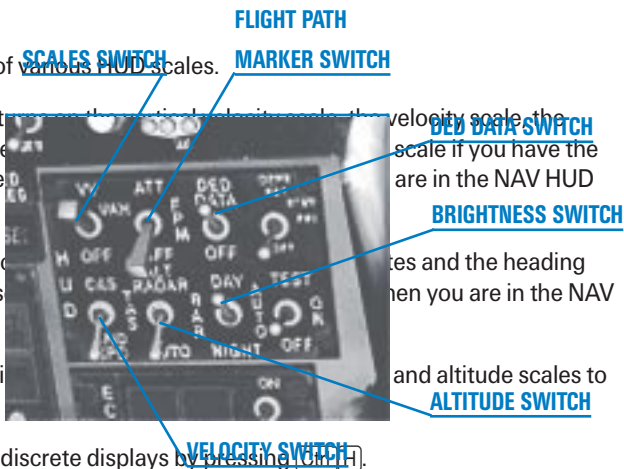



Flight Path Marker Switch

This switch selects various modes of display for the FPM (Flight Path Marker). The ATT position selects both the attitude reference bars (the pitch ladder) and the flight path marker. The FPM position displays only the flight path marker. The Off position removes both the pitch ladder and the flight path marker. You can also cycle through these settings by pressing [H].

DED Data Switch

This switch controls the DED display on the HUD. When the switch is in the DED Data position, the information on the DED is displayed in the lower part of the HUD in the HUD Only view.

Velocity Switch

This 3-position switch adjusts the speed indicator on the HUD to reflect either CAS, TAS or Ground speed. An identifier appears next to the speed readout on the HUD indicating which airspeed readout is selected: T = True, C = Calibrated and G = Ground speed. The velocity switch defaults to calibrated airspeed.

Altitude Switch

This switch determines which type of altitude scale is used. When set to Radar, the HUD displays a radar altitude scale which is altitude AGL (Above Ground Level). When the switch is set to Bar, the HUD uses a barometric altitude scale which is MSL (Mean Altitude Above Sea Level). Auto uses an automatic altitude scale that switches to radar altitude once you're below 1,500 feet AGL.

The barometric altitude scale gives you and your wingmen a common reference value. 15,000 feet above sea level means the same to everyone. Use radar altitude when you want to know your specific altitude over land. Even though you may be flying at 2,000 feet MSL, your altitude above ground may only be 600 feet.

In most cases, you should set the altitude switch to Auto mode. This will give you an altitude display of MSL except when you are near the ground, in which case AGL becomes more important.

Brightness Control Switch

This switch sets the intensity of the HUD display for either day flying or night flying. Day sets the display to full brightness. Night sets the display to half brightness. Auto automatically maintains an appropriate brightness.

AUXILIARY THREAT WARNING PANEL

SRCH

Press the SRCH button to display search radars on the RWR. When this button is pressed, the TWS detects a radar emitter in search mode and displays an "S" on the RWR indicating bearing and proximity. If a search radar is detected but this button is unlit, it will flash.

ACT

The ACT light indicates radar activity has been detected.

LOW

Press the LOW button to give priority to threats that are more dangerous when you are at a low altitude such as AAA guns and low-altitude SAMs (Surface-to-Air Missiles). When not lit, it gives priority to threats more dangerous when you're at a higher altitude such as air-to-air radars and high-altitude SAMs. If Easy Avionics is selected, this toggle is automated.

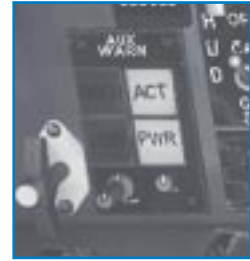

PWR

This button controls the power to the RWR system. It defaults to on, which means the RWR has power. If you turn power off, you will not see any RWR or threat warning activity.

ECM TOGGLE SWITCH

The ECM (Electronic Countermeasures) switch turns the ECM pod (if one is loaded on your F-16) on or off. You can also toggle the ECM system by pressing **J**.

When the ECM system is turned on, the left light (PWR) will illuminate. The right light (FAIL) only lights if the ECM has a problem, which means that ECM may not be reliable.



MANUAL PITCH OVERRIDE SWITCH

This switch sets the manual pitch control to normal or override. It is used during a deep stall to allow recovery of the aircraft. You can find detailed information about deep stall conditions and how to recover from them in **Chapter 2: Learning to Turn** and **Chapter 25: Aerodynamics and G Forces**. You can also press **O** to toggle the MPO switch.

RADIO CHANNEL

This radio channel selector is used to dial in a communications channel. The maximum range of the radio is 300 nm. The first number indicates which radio is active: COM1 or COM2. The second number indicates which comm channel you are on. Your F-16 has eight radio channels:

- 0 Off
- 1 To and from your flight
- 2 To your package
- 3 To and from your package



- 4 Proximity (anything to and from your team within 40 nm)
- 5 Guard (anything said to and from your team)
- 6 Broadcast (anything broadcast to the world)
- 7 To and from the tower or tanker your TACAN is tuned to

If the radio is set to channel 0, the radio is off.

If the radio is set to channel 1, you will only hear messages to and from your flight. For all other channels, messages to and from your flight are always included.

If set to channel 2, you will hear messages to your package. If set to 3, you'll hear messages to and from your package. Channel 2 is a filtered communications channel. Only communications to members of your package are heard on this channel. On channel 3, you can hear communications to your package as well as communications from your package to aircraft outside your package.

If the radio is set to channel 4, the proximity filter will pick up everything said to your team within a 40 nm radius. If set to channel 5, you'll hear everything to and from your team.

When the radio is set to channel 6, you will hear messages to everyone. This is useful in multiplayer dogfights. However, everyone must be on channel 6 to hear each other.

When set to channel 7, you will hear calls to and from the tower your TACAN is tuned to.

Note that whichever channel you are tuned to, the AWACS will always hear you and you will always hear them. You will always hear AWACS, the tower and the tanker when they talk to you. To talk to the tower or tanker, you need to tune to the appropriate TACAN channel. The TACAN channel info for the tower is on the enclosed map of Korea or on your DED if you are diverted to a new airfield. The TACAN channel info for the tanker is sent by AWACS.

RADIO FUNCTION KNOB

Set the radio function knob to Backup if you want to change the radio channel using the radio channel selector. Set the knob to Norm if you want to use the increment and decrement arrows on the ICP.

AUXILIARY COMM PANEL

For more information on how to use the CNI switch, the TACAN station selector and the TACAN function knob, see "Navigation System" below.

**RADIO CHANNEL
SELECTOR**

**RADIO
FUNCTION KNOB**

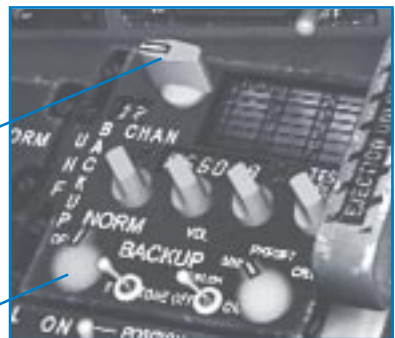

CNI Switch

The CNI (Communications, Navigation, IFF) switch indicates where navigation data will be coming from. When set to the UFC (Upfront Controls) position, the navigation system uses the ICP. Specifically, data is taken from programmed steerpoints, markpoints or datalink points. When set to Backup, navigation data comes from the TACAN channel programmed into the TACAN station selector.

TACAN Station Selector

The TACAN (Tactical Air Navigation) system provides continuous bearing and distance information from a selected TACAN station within a line-of-sight distance of approximately 390 miles. The TACAN bearing, selected course, range and course deviation information are displayed on the HSI according to the settings of the HSI and Instr Mode knob.

TACAN uses two bands. The X band is used only for ground stations, while the Y band can be used for both ground stations and air operations (such as tanker operations).

TACAN Function Knob

Set the TACAN function knob to AA-TR (Air-to-Air/Transmit Receive) to determine that the TACAN signal comes from a tanker. Set the knob to TR (Transmit Receive) to determine that the signal comes from an airbase.

Exterior Aircraft Lights Toggle

This switch controls all the exterior lights on your aircraft. When set to Off, all lights are extinguished. You can also toggle the exterior lights by pressing [Scroll Lock](#).

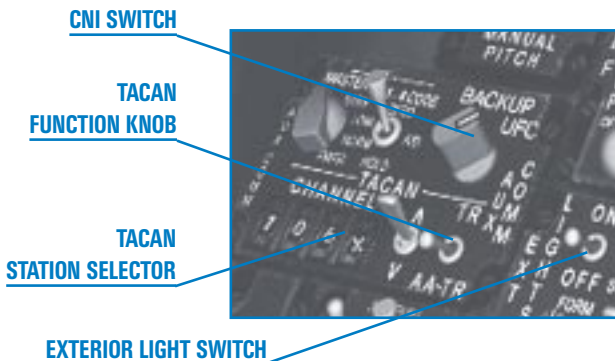

RIGHT AUXILIARY CONSOLE

MAGNETIC COMPASS

The magnetic compass shows your current heading with respect to the magnetic north. It is marked N, E, S and W for the four cardinal directions with markers every 30°. Since this device is not tied into the aircraft's electrical system, it will function even if your HUD or HSI is damaged.



FUEL QUANTITY INDICATOR

The fuel quantity indicator displays the total amount of fuel you have. Read the total amount of fuel in pounds in the digital readout at the bottom of the gauge. The red hand displays your internal tank, and the gray hand shows the amount of fuel left in any external tanks.

CAUTION LIGHT PANEL

The caution light panel contains 12 individual lights that, when lit, indicate problems with onboard systems. Whenever one of these lights comes on, the Master Caution lamp will also be lit. Turn off the Master Caution lamp by clicking it or pressing **Ctrl** **C**.

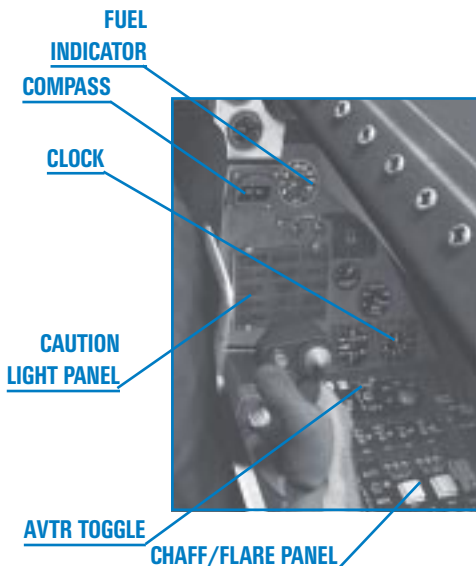

FLT CONT SYS When lit, this caution light indicates a general failure of the flight control system. Expect your flight controls to be very sluggish and to have difficulty in controlling your aircraft. Jettison all unnecessary stores and land as soon as possible.

FUEL LOW This indicates that you have reached a specific minimum quantity fuel status. The Fuel Low light will come on when you have 750 pounds of fuel

left. Check to see if this condition is caused by a fuel leak due to damage. If so, reduce your fuel flow to the minimum required to maintain flight and try to hit a tanker or land as soon as possible. Otherwise, it's time to return to base. Refueling will not turn off the Fuel Low warning.

ECM

This light indicates that the ECM system is no longer functional. You will not be able to jam enemy radar.

LE FLAPS

The LE (Leading Edge) Flaps caution light indicates a problem with the FLC control over the leading edge flaps. Since the flaps will not be engaged, your control of the aircraft during low speed flight will be

adversely affected and you will land at a faster airspeed.

AVIONICS	This indicates a general fault with the system avionics or FLCS. You'll have to examine the other caution or warning lights to determine additional details about the problem.
HOOK	The F-16 has a hook that is used only in emergency landings. Normally, the hook is in the up position. When this caution light is illuminated, the hook is not up and locked. You probably won't see this fault occur.
ENGINE FAULT	This caution light indicates that there is a loss of valid data to the engine. This will result in loss of some or all of your engine capabilities.
RADAR ALT	This light indicates a malfunction of the radar altimeter. If it is lit, you won't have a functional radar altimeter (including the AL display on the HUD). You still have the use of the barometric altimeter for altitude data.
NWS FAIL	When this light is illuminated, it means that the nose wheel steering system has failed. You will have no ability to steer the aircraft while on the ground.
OVERHEAT	When this caution light is on, it indicates an engine overheat condition. Reduce throttle to the minimum needed to fly and land as soon as possible. Your engine will eventually explode if this condition persists.
IFF FAULT	If there is an IFF fault, other aircraft may not be able to identify you electronically.
CABIN PRESS	This light indicates low cabin pressure. Because you're wearing an oxygen mask, a low cabin pressure situation won't have much of an effect on you.

CLOCK

The clock is a real-time clock which indicates the current time of day in the *Falcon 4.0* world. The little gray hand indicates the hours, the large gray hand shows the minutes and the red hand displays the seconds.



In Instant Action and Dogfight, the clock starts with the time of day that was set in the user interface. In Campaign and Tactical Engagement, the time of day is set by the game.

AVTR TOGGLE

The AVTR (Audiovisual Tape Recorder) records activity through the HUD gun camera. All activity near your plane (including your F-16, other aircraft and ground units) is recorded and can be played back in the ACMI. When the AVTR is on, the word "Recording" is displayed onscreen. Toggle the AVTR by pressing **[F]**. For more information, read **Chapter 14: ACMI**.

CHAFF/FLARE CONTROL PANEL

The chaff and flare panel controls the disbursement of chaff and flare cartridges from the ALE-40 chaff/flare dispenser. Chaff and flares are used as countermeasures for radar-guided and heat-seeking missiles, respectively.

Chaff Count Indicator

The chaff count indicator shows the number of chaff cartridges available. The F-16 is initially loaded with 60 chaff cartridges.

Chaff Dispense Button

The chaff dispense button causes a chaff cartridge to be ejected from the aircraft. You can also press **[X]** to release chaff.

Flare Count Indicator

The flare count indicator shows the number of flare cartridges available. The F-16 is initially loaded with 30 flare cartridges.

Flare Dispense Button

The flare dispense button causes a flare cartridge to be ejected from the aircraft. You can also press **[Z]** to release flares.

Auto/Man Switch

The auto/manual chaff/flare switch has two settings. When it's set to MAN, chaff and flares are dispensed only when the pilot hits the chaff or flares dispense buttons. When set to AUTO, two chaff cartridges and a flare are automatically dispensed whenever the TWS detects a launch. You can also press **[Alt][Z]** to toggle between automatic and manual.

NAVIGATION SYSTEM

The table below breaks down how to use your navigation system. The first column lists the objective (what you want to do). The second column shows the settings for various switches and knobs. The third column shows the effects on these settings on the HSI (if any). The fourth column shows the effects of the same settings on the ADI (if any).

The navigation system in your F-16 is composed of many interconnected parts: the mission computer, the TACAN channel selector, the HSI, the ADI, etc. Essentially, navigation data comes from either the mission computer or the TACAN system. Which data source depends on a number of different switches and settings. The navigation data ends up on the HSI and the ADI.

In the table below, the first four examples use the NAV mode for navigation. The Nav system is the part of the mission computer that remembers steerpoints and markpoints. Use the ICP to select your destination and set the Instr Mode selector switch to either NAV or NAV/ILS.

The remaining examples use the TACAN system for navigation. The TACAN system consists of the TACAN channel selector, the TACAN function knob and part of the mission computer. At the start of Campaign and Tactical Engagement missions, the mission computer looks up and stores the associated TACAN channels for any landing and refueling steerpoints.

The TACAN channel selector lets the pilot input navigation data manually.

The TACAN function knob determines whether the TACAN signal is coming from a tanker (AA-TR) or an airbase (TR).

The CNI switch determines whether the TACAN signal comes from the mission computer (UFC) or the TACAN channel selector (Backup).

The ILS bars on the ADI only function when the Instr Mode selector switch is set to either NAV/ILS or TCN/ILS.

Objective	Settings	HSI	ADI
Fly to a steerpoint	Set ICP to STPT Set CNI switch to UFC Set Instr Mode selector switch to NAV		
Land on an	Set ICP to STPT		ILS bars on



airbase runway (landing point)	Set CNI switch to UFC Set Instr Mode selector switch to NAV/ILS		ADI in view
Fly to a markpoint	Set ICP to MARK Set CNI switch to UFC Set Instr Mode selector switch to NAV		
Fly to a tanker using manual TACAN	Set TACAN function knob to AA-TR Set CNI switch to Backup Set Instr Mode selector switch to TCN	Course warning flag is set To-From indicator in view	
Fly to an airbase using manual TACAN	Set TACAN function knob to TR Set CNI switch to Backup Set Instr Mode selector switch to TCN	To-From indicator in view	
Land at an airbase using manual TACAN	Set TACAN function knob to TR Set CNI switch to Backup Set Instr Mode selector switch to TCN/ILS		ILS bars on ADI in view
Fly to a preset airbase using TACAN	Set ICP to T-ILS Set CNI switch to UFC Set Instr Mode selector switch to TCN	To-From indicator in view	
Land at a preset airbase using TACAN	Set ICP to T-ILS Set CNI switch to UFC Set Instr Mode selector switch to TCN/ILS		ILS bars on ADI in view
Fly to a preset tanker	Set ICP to T-ILS Set CNI switch to UFC Set Instr Mode selector switch to TCN	To-From indicator in view Course warning flag is set	

Let's navigate to a preset airbase using TACAN (the eighth example in the table above). Campaign and Tactical Engagement missions have preprogrammed TACAN channels for your airbase. First, select the preset TACAN channel for the airbase by pressing the T-ILS button on the ICP. Then, set the CNI switch to UFC and the Instr Mode selector switch to TCN/ILS. If your runway is at a heading of 270°, for example, the DED will show "Runway 27." Dial in the course setting of 270 with the HSI course knob.

Now let's navigate to a specific airbase using manual TACAN (the sixth example in the table above). Look up the TACAN channel on the Korean map (for example, "105X" for Seoul airbase). Set the TACAN function knob to TR, set the CNI switch to Backup and set the Instr Mode selector switch to TCN/ILS. Now dial in TACAN channel "105X" by clicking on the numerals. This sets your bearing pointer to point toward the station you dialed in on your TACAN receiver—in this case, Seoul airbase.

Use bearing and distance to merge with a tanker, but ignore any other course information since the tanker is continually moving.

CHAPTER

18



THE HUD

The HUD (Head-Up Display) is one of the most important pieces of equipment in your F-16. The HUD appears in the front-center of your cockpit and combines information from your navigational system, FCR (Fire Control Radar) and FCC (Fire Control Computer) into one integrated through-the-window display. The real value of the HUD is that it provides all the important information you need without making you look down into the cockpit.

Each weapon you select has an associated HUD mode that displays information specific to that weapon. Each of the HUD weapons modes is covered below, but we'll examine the common elements on the HUD first.

BASIC HUD INFORMATION

The following items are common to most HUD modes and are useful for normal flight.

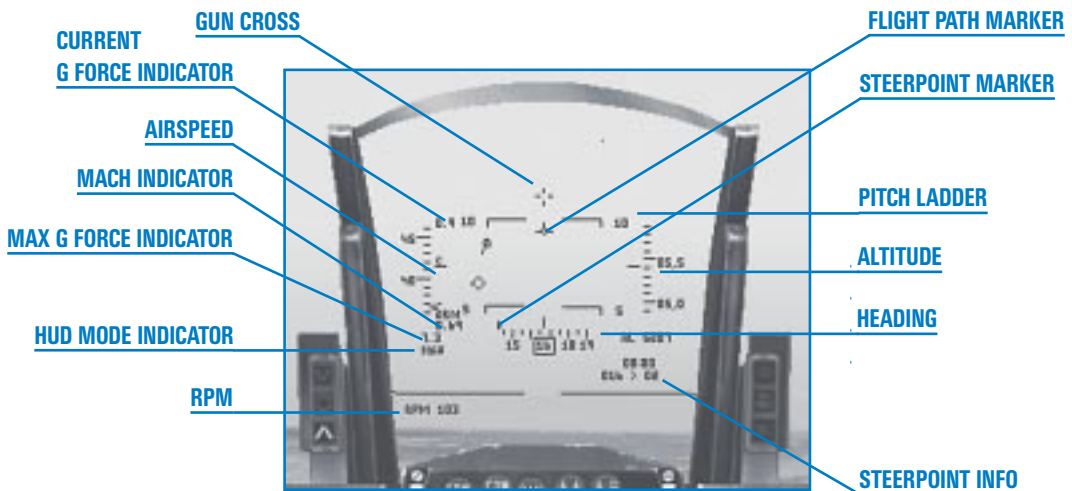

AIRSPEED

The airspeed indicator shows your current airspeed in knots (nautical miles per hour). If set to Realistic avionics, the lowest airspeed reading is 60 knots (not zero).

Airspeed can be displayed as either a discrete, a tape or both. The discrete indicator consists of a number inside the rectangle on the left side of the HUD. The tape consists of a moving, calibrated display on the left side. Airspeed is displayed every 50 knots, with hash marks indicating every 10 knots. Airspeed is read from a tick mark to the right of the tape and can be displayed as calibrated ("C" for CAS), true ("T" for TAS) or ground speed ("G" for Ground).

Set the scales switch on the HUD control panel on the left console to "VV" to display airspeed as both a tape and discrete. Set the switch to "VAH" to display the airspeed as a tape. Set the switch to "OFF" to display the airspeed as a discrete. You can also press **Ctrl**+**H** to set the scales switch.



ALTITUDE

The altitude indicators are on the right side of the HUD and display either as a discrete value (inside a rectangle) or as a tape. The discrete indicator gives altitude accurate to the foot. The altitude tape is marked in increments of 100 feet (for example, "10,5" for 10,500 feet). Read the tape by looking at the tick mark on the left side of the scale.

The altitude measurement in this display depends on the setting of the altitude switch on the HUD control panel. When set to "BAR" (Barometric), the altitude scale measures MSL (Mean Altitude Above Sea Level). When set to "RADAR," the scale measures AGL (Altitude Above Ground Level). When set to "AUTO," the scale uses the barometric altitude until you fly below 1,500 feet AGL ascending or 1,200 feet descending. Then the scale automatically switches to radar altitude, which is a fixed scale from 0 to 1,500 feet.

The upper end of the bracket on the left of the scale moves to mark your altitude against the scale. In addition, the sideways "T" mark on the scale indicates the current setting of ALOW. If you select the radar altimeter when the altimeter is set to the tape, an "R" appears above the tick mark.

ALTITUDE LOW

Underneath the altitude tape, the altitude low indicator is displayed as the letters "AL" and your altitude in feet. The flashing AL indicator only appears when your altitude drops below the ALOW setting. This setting is initially 300 feet AGL, but you can change it by clicking the ALOW button on the ICP (Integrated Control Panel). See **Chapter 20: The ICP and DED** for more information.

The AL display always shows AGL. When you fly below the ALOW value, the AL indicator will flash and you will hear the VMS (Voice Messaging System) warning "ALTITUDE-ALTITUDE."

HEADING

The heading indicator tells you which compass direction you are flying in. Headings are displayed in degrees with 0° = North, 90° = East, 180° = South and 270° = West. The heading tape is calibrated in 5° increments. The heading tape is displayed at the bottom of the HUD for navigation and air-to-air weapons modes vs. at the top of the HUD for air-to-ground weapons modes and ILS mode.

The heading tape can be removed from the HUD by setting the scales switch on the HUD control panel to "OFF."

FLIGHT PATH MARKER

The FPM (Flight Path Marker) indicates the actual direction of flight your aircraft is taking, which may not always be the exact direction the nose of your F-16 is pointing. The flight path marker is displayed as a circle with three spokes representing your wings and tail. It will lag behind the center of the HUD as you bank and then slowly drift back to the center as you straighten out. If the flight path marker is below the horizon, you are descending towards the earth. The difference between where you are pointing (indicated by the gun cross on the HUD) and where your flight path marker is your AOA (Angle of Attack).

The flight path marker can be turned on or off with the FPM switch on the HUD control panel. You can also press **[H]** to declutter the HUD.

If the wind is blowing, this will affect the flight path marker's position on the HUD.

G FORCE INDICATOR

The G force indicator is a discrete readout in the upper left corner of the HUD. It indicates the G forces you are experiencing at any given moment. When you are flying straight and level, the G force indicator will read 1.0. The F-16 can pull up to 9.0 Gs. See **Chapter 25: Aerodynamics and G Forces** for more information.

MAX G FORCE INDICATOR

This indicator, in the lower left quadrant of the HUD, indicates the highest G force your F-16 has experienced on the current mission. This indicator is automatically set to 1.0 at takeoff. The max G force indicator tells your crew chief how much you've stressed the airframe.

HUD MODE INDICATOR

The HUD mode indicator in the lower left corner indicates which HUD mode is being displayed.

BSGT	Boresight Electro-Optical Weapon Deliver Submode
CCIP	Continuously Computed Impact Point
CCRP	Continuously Computed Release Point
DGFT	Dogfight
DTOS	Dive Toss
EEGS	Enhanced Envelope Gun Sight
HTS	HARM Targeting System
ILS	Instrument Landing System
LCOS	Lead Computing Optical Sight
LGB	Laser-Guided Bombs
MRM	Medium-Range Air-to-Air Missile
MSL	Missile Override Mode
NAV	Basic Navigation



RCKT	Rockets
RPOD	Reconnaissance Pod
SLAVE	Slaved Weapons Delivery Submode
SNAP	Snapshot
SRM	Short-Range Air-to-Air Missile
STRF	Ground Strafe

MACH INDICATOR

Located above the max G force indicator, the Mach indicator displays the current airspeed as a percentage of Mach 1 (the speed of sound). A useful rule of thumb is to figure that you will travel 1 nm/minute for every tenth of a Mach in level flight. For example, if the Mach indicator reads 0.6 Mach, you will travel approximately 6 miles in the next minute.

PITCH LADDER

The pitch ladder appears in the center of the HUD and consists of parallel lines marked to indicate your angle of climb or dive. The lines also rotate to indicate the roll of your aircraft. As you climb or dive, the lines move accordingly. Since the lines orient to the horizon, they continue to indicate the line of the horizon as you roll. Marked in increments of 5° of climb or dive, the pitch ladder lines have tick marks on each end that point toward the 0° line. If you get disoriented in a climb or dive, steer the plane in the direction of the tick marks to come back to level orientation. Positive pitch angles have solid bars; negative pitch angles have dashed bars. If the wind is blowing, this will affect the position of the pitch ladder on the HUD.

In Easy Avionics, the pitch ladder appears only if the nose of your plane is 20° above or below the horizon.

The pitch ladder is turned on by default and also comes on automatically when the landing gear is down. Remove it from the HUD by pressing **[H]**.

STEERPOINT MARKER

The steerpoint marker appears as a bold tick line above the heading tape. It indicates the heading for the current steerpoint. If the steerpoint heading is not in the viewable heading tape, the steerpoint marker will appear on the side of the heading tape closest to the steerpoint heading. As you match your heading to that of the current steerpoint, the steerpoint marker will move above the heading tape to the correct position. When the steerpoint marker is aligned with the heading tape's reference tick, you are on a direct path to the current steerpoint.

GUN CROSS (BORESIGHT CROSS)

The gun cross is the cross at the top of the HUD that represents the fuselage reference line and the direction your plane is pointing. The gun cross is displayed in every HUD mode.

LOW FUEL

When your fuel gets down to 1,400 pounds, the center of the HUD will display a flashing “WARN FUEL” and the VMS will say “BINGO–BINGO” to warn you that you are low on gas. In addition, a “WARN FUEL” readout will appear in the lower left corner of the HUD. Click the Master Caution light (or press **Ctrl** **C**) to make the flashing “WARN FUEL” message disappear and silence the VMS. The other “WARN FUEL” message will remain. Every time your fuel amount is halved, “WARN FUEL” will flash in the center of your HUD and the VMS will say “BINGO–BINGO.”

SOI (SENSOR OF INTEREST)

Because the avionics of the F-16 are complex, determining the SOI (Sensor of Interest) can be confusing. Therefore, we have semi-automated this in *Falcon 4.0*. SOI only applies to LGBs (Laser-Guided Bombs) and Mavericks.

Essentially, before you designate or ground-stabilize any sensor, the SOI for LGBs is radar and the SOI for Mavericks is the HUD. Once you designate the target or ground-stabilize, the SOI is either the LGB laser pod or the Maverick electro-optical camera. Think of pre-designate as general aiming and post-designate as fine-tuning the aimpoint.

For example, let’s consider using LGBs in boresight mode. Call up the air-to-ground radar and the laser designator display on the two MFDs. Since the laser designator is in boresight mode, the MFD will display “NOT SOI.” The HUD will display “SOI” in the upper left-hand corner because boresight mode ties targeting to the HUD. After ground-stabilizing, the “SOI” label disappears from the HUD and “NOT SOI” disappears from the laser designator as it then becomes the SOI for fine-tuning your aimpoint.

Let’s consider using LGBs in slave mode. Call up the air-to-ground radar and the laser designator on the two MFDs. Switch to slave mode by pressing the **□** key. Since the laser designator is in slave mode, the laser pod display will display “NOT SOI.” As the HUD does not display “SOI” either, this makes the radar the SOI by default. Slew the radar cursors onto a target and lock it up. Once you designate a target with the radar, the “NOT SOI” label will disappear from the laser pod display. The laser will now designate whatever the radar has locked. Note, however, that you cannot fine-tune your aimpoint in slave mode as the laser is tied to the radar system.

BREAK-X

The Break-X indicator appears as a large flashing “X” across the HUD. The Break-X indicates that you are in imminent danger of collision with another aircraft or with the ground. If you have locked up an aircraft on radar, the Break-X usually refers to an air-to-air collision. Make a hard break to avoid the other plane. If you are in danger of crashing into the ground, the Break-X will flash in the HUD. You will also hear the VMS say “PULLUP–PULLUP.” Pull up to avoid crashing your plane into the ground.



RPM

The RPM (Revolutions Per Minute) readout in the lower left corner of the HUD indicates the engine's RPM. 70 is idle, 100 is full military power and 103 is full afterburner.

OTHER HUD MODES

The HUD displays special modes for navigation and weapons.

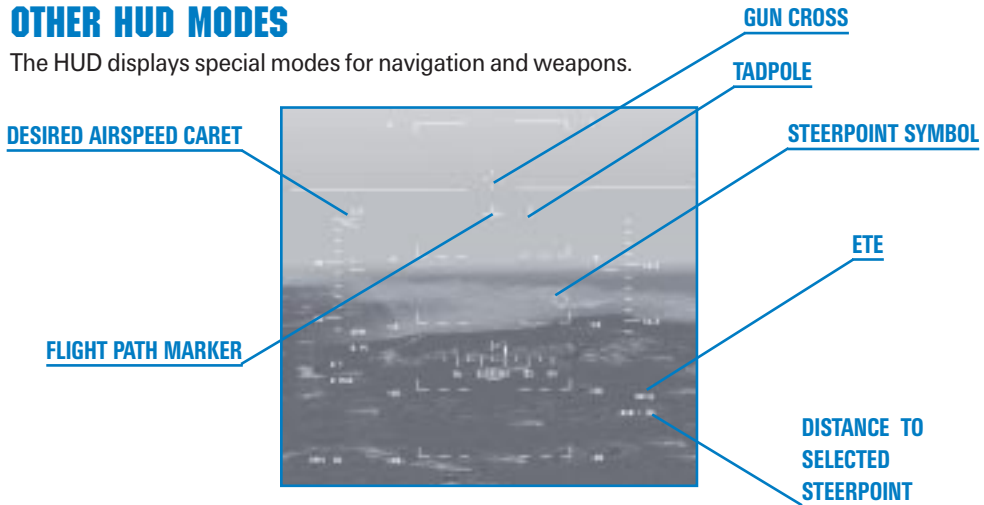

NAV MODE

NAV mode is the HUD mode when you have not called up any weapons. You can also call it up by pressing the NAV button on the ICP. The NAV HUD mode includes displays specifically used for navigation.

Steerpoint Symbol

The steerpoint symbol is a diamond that appears on the HUD when you are in the NAV HUD mode and the current steerpoint is within the FOV (Field of View) of the HUD. Align the flight path marker above or on the steerpoint symbol to fly directly to your next steerpoint. Since the steerpoint symbol is actually placed on the ground at the position of the steerpoint, you need to adjust your altitude for the steerpoint symbol. Note that if the steerpoint is not within the FOV of the HUD, you won't see it. Use the tadpole when you are not pointing at your steerpoint.

Tadpole

The tadpole is another navigation marker on the HUD. It is always present while in NAV HUD mode. It consists of a small circle with a tail on it. The tail points in the direction of the current steerpoint. For example, if the steerpoint is to your right and behind you, the tail of the tadpole will be down and to the right. To fly to the steerpoint, put the flight path marker on the tadpole. The tadpole, unlike the steerpoint, takes the steerpoint's altitude into consideration.



THE AIM-120 AMRAAM

The AIM-120 AMRAAM (Advanced Medium-Range Air-to-Air Missile) is a powerful, BVR (Beyond Visual Range) weapon in your Falcon's arsenal. The AIM-120 (also known as the "Slammer") uses a combination active/semi-active radar seeker built into the missile. Your FCR (Fire Control Radar) locks up the target and directs the missile toward it. At a certain point, the AIM-120's own radar starts tracking the target, at which point it is then no longer necessary to keep the F-16's radar locked onto the target. The AIM-120 has an maximum range of more than 20 nm and an effective range of 15 nm on a closing target.

When the AMRAAM launches, you'll see it typically zoom up to get into its optimum travel arc. Because the motor usually burns out before the missile reaches the target, the AIM-120 has to coast the rest of the way, so it gains altitude while it has power. Even though the AMRAAM may coast partway to its target, it can still maneuver. You'll see the missile's exhaust trail disappear after it has traveled a certain distance.

AIM-120 Reticle and Allowable Steering Error Circle

When MRMs (Medium-Range Missiles) are selected, the HUD shows "MRM" in the HUD mode indicator. A large circular reticle (an optical focus point used for aiming) appears in the center of the HUD. This circle is used as a reference to guide your aircraft to the target, described below under "Attack Steering Cue."

Once a target is locked up on the FCR, a target aspect angle marker appears on the circumference of the circle. If it is at 6 o'clock, the target aspect angle is 0° (going away from you). The 12, 3 and 9 o'clock positions correspond to 180° aspect (coming right at you), 90° right and 90° left aspect. The aspect marker can appear at any position on the circle.

If a locked target is within 12,000 feet, four ticks appear on the circle at the 12, 3, 6 and 9 o'clock positions. (The range is 12,000 feet for Realistic Avionics mode only; the ticks appear as soon as a target is locked in the other modes.) A range tick also appears inside the circle starting at the 12 o'clock position when the target is within 12,000 feet and extends counterclockwise around the circle. This range tick indicates the selected target's range from you in thousands of feet. For example, if the tick is at the 9 o'clock position, the target is 9,000 feet from you.

When the target is within maximum range, the missile diamond will flash. When the target is at the top of the maneuver bracket of the DLZ (see below), the steering circle will flash.

Target Designator Box and Locator Line

A locked target shows up as a diamond with four spokes inside a TD (Target Designator) box.

When the target is outside the HUD field of view, a target locator line is drawn from the gun cross to the target. An angle-to-target display appears to the left of the gun cross. It indicates the angle (in degrees) to the target.

Dynamic Launch Zone and Maneuvering Zone Scales

The DLZ (Dynamic Launch Zone) ranging scale appears once a target has been locked up. The DLZ scale is really two scales that change in size depending on the radar range setting and the distance, speed, altitude and aspect angle of the locked target.

The outer brackets represent the maximum and minimum range for *non-maneuvering* targets. The inner brackets are the maneuver zone markers. They indicate the maximum and minimum ranges for a successful launch against *maneuvering* targets. In other words, the brackets for non-maneuvering targets indicate the range that the missile has the kinetic power to reach. However, if the target is maneuvering, some of the missile's kinetic energy is spent following the target and, thus, its range to successfully track and reach this target is decreased. This effective range, sometimes referred to as the "no-escape zone," is represented by the inner brackets.

The range represented by the DLZ corresponds to the selected radar range scale of 80, 40, 20, 10 or 5 nm. This number is displayed above the DLZ. The range will automatically set to 5 nm if the range to the target is less than 4.5 nm. The size of the DLZ changes according to the radar range and the distance to the target.

Range Caret and Closure Rate

When a caret is to the left of the DLZ, it indicates that the designated target is within the maximum non-maneuvering target range. The number to the left of the caret shows the target's closure rate. If the caret is above the DLZ, the target is outside the missile's maximum range.

Active Seeker Range Cue

Appearing on the inside bracket of the DLZ, the active seeker range cue indicates the range where the AIM-120's seeker head becomes active after launch. It is the distance measurement for this event while the Time Until Active readout (below) is the time measurement.

Missile Time of Flight and Time Until Active

When you launch a missile, the time of flight countdown is displayed in the lower right corner of the HUD. The time of flight countdown is labeled with a "T" and counts down in seconds. If the target is far enough away that the missile's own radar seeker won't be able to lock onto the aircraft, the missile has to be steered by your F-16's radar. The time until the missile seeker head becomes active is displayed above the time of flight readout. It is preceded with an "A" and the number represents the seconds until the seeker head becomes active.

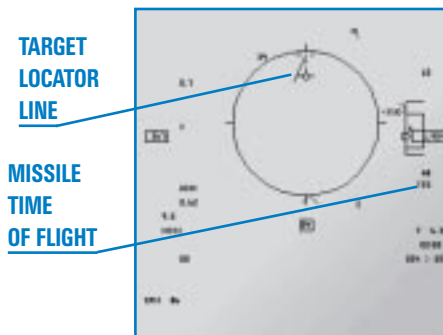



Attack Steering Cue

The attack steering cue is a small circle that is used for two actions. When the target is outside the DLZ, the attack steering cue provides *aircraft*-to-target intercept steering. When the target is inside the DLZ, it provides *missile*-to-target intercept steering.

In either case, you should maneuver the attack steering cue to the center of the reticle. For aircraft intercept, this will put you on the most effective intercept course. For launching a missile, placing the cue in the center of the reticle will give your missile an optimum intercept course. There is a corresponding cue on the radar, the intercept steering cue, when you have a target locked up.

If the appropriate position for the attack steering cue places it outside of the field of view of the HUD, the cue is placed at the edge of the HUD closest to the position.

Range to Target

Once you lock onto the target, the distance to the target is displayed in the lower right of the HUD. This readout is labeled with an “F.” The distance is displayed to the nearest tenth of a mile if greater than 1 nm. If it is less than 1 nm, the distance is displayed in hundreds of feet.

AIM-7 SPARROW

The AIM-7 Sparrow is a beam-riding medium-range missile. This means that in Realistic Avionics, you must have a target locked up in Single Target Track radar mode and keep it locked from launch to impact. (In Easy or Simplified Avionics, you need to have locked onto a target in any radar mode.) Unlike the AIM-120, which has its own guiding radar, the AIM-7 is completely dependent on your aircraft radar to guide it to its target. If you break lock or the target aircraft beams (flies at a perpendicular course to your missile) to break your lock, the AIM-7 will lose track.

The maximum range for the AIM-7 is 18–20 nm for a head-on shot. The maximum maneuvering range is 12–15 nm. The AIM-7 Sparrow HUD mode is identical to the AIM-120 HUD mode.

Short-Range Missiles

The F-16 also carries the AIM-9 short-range heat-seeking air-to-air missile, nicknamed the Sidewinder. Your F-16 carries two Sidewinders standard.

The AIM-9 is called an SRM (Short-Range Missile) because its typical range is 1 to 4 nm. The AIM-9 has a maximum range of 10 nm, an effective range of 4 nm on a closing target and an effective range of 2 nm on a target flying away from you. AIM-9s are also known as VWR (Within Visual Range) weapons since you’ll almost always have visual contact with your enemy.

Two models of the AIM-9 are available. The P model is the standard rear-aspect version. You need to be on the enemy’s rear to score a hit with AIM-9Ps because they need to see a substantial heat source—the enemy aircraft engine—to lock onto. The M model is an all-aspect weapon, which means that you can fire at the enemy from any angle. The AIM-9M’s seeker head is sensitive enough to pick up a heat signature from any angle, although your probability of kill increases if you’re on his six. (The L model is an older version of the all-aspect AIM-9M.)

AIM-9 RETICLE

When SRMs are selected, the HUD shows "SRM" in the HUD mode indicator. A medium-sized circular reticle appears in the center of the HUD. You want to position an enemy aircraft within the reticle when firing a Sidewinder.

Once a target is locked up on the FCR, a target aspect angle marker appears on the circumference of the circle. If it is at 6 o'clock, the target aspect angle is 0° (heading away from you). The 12, 3 and 9 o'clock positions correspond to 180° aspect (coming right at you), 90° right and 90° left aspect. The aspect marker can appear at any position on the circle.

If a selected target is with 12,000 feet, four tick marks appear on the circle at 12, 3, 6 and 9 o'clock positions. (The range is 12,000 feet for Realistic Avionics mode only; the ticks appear as soon as a target is locked in the other modes.) A range gap, marked by a range tick, also opens in the circle starting at the 12 o'clock position when the target is within 12,000 feet and extends counterclockwise around the circle. This range tick indicates the selected target's range from you in thousands of feet. For example, if the tick and gap are at the 9 o'clock position, the target is 9,000 feet from you.

When the FCR has determined you have a successful lock on the target and are within range (that is, within the outer brackets of the DLZ—see below), the AIM-9 reticle will start flashing, telling you can take a shot. This only happens when the target is locked on radar. If you are only using the missile seeker head to pick up an IR (Infrared) signal on the target, you won't see the flashing reticle. Instead, you'll have to rely on the tone sound, proper position and aspect angle to determine when to take a shot. If you are firing the AIM-9P, aspect angle should be between 4 and 8 o'clock.

TARGET DESIGNATOR BOX AND LOCATOR LINE

When the target is outside the HUD field of view, a target locator line is drawn from the gun cross to the target. An angle-to-target display appears to the left of the gun cross. It indicates the angle (in degrees) to the target.

DYNAMIC LAUNCH ZONE AND MANEUVERING ZONE SCALES

The DLZ for the AIM-9 works exactly the same as for the AIM-120 AMRAAM, as described above.

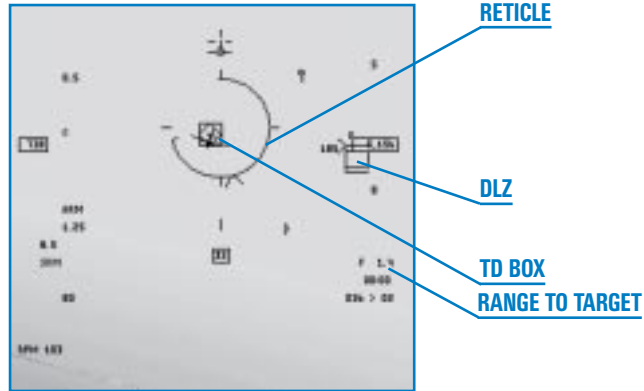

RANGE CARET AND CLOSURE RATE

When a caret is positioned to the left of the DLZ, it indicates that the designated target is within the maximum non-maneuvering target range. The number to the left of the caret shows the target's closure rate. If the caret is above the DLZ, the target is outside the missile's maximum range.



RANGE TO TARGET

Once you lock onto the target, the distance to the target is displayed in the lower right of the HUD. This readout is labeled with an "F." The distance is displayed to the nearest tenth of a mile if greater than 1 nm. If it is less than 1 nm, the distance is displayed in hundreds of feet.

MISSILE TIME OF FLIGHT

When you lock up a target, a readout appears beneath the DLZ indicating the estimated time of flight (in seconds) of a missile if it were launched at the selected target. When you launch a missile, this number is duplicated below the initial readout and starts to count down the time remaining in seconds. The top readout adjusts as necessary to indicate the estimated time of flight for the *next* missile to hit the target.

SEEKER HEAD TONE

The AIM-9 heat-seeking missile gives you audio feedback when it locks onto a heat source. When you select the missile, you'll hear a typical low-pitched warble, indicating that the seeker head is picking up background heat but no specific heat target. Once it locks onto an infrared target, the pitch rises and the warble cycle increases proportionate with the intensity of the lock. You should wait until the tone is high, loud and fast before firing.

Normally, the seeker head is slaved to the radar so that when you lock a target with your radar, the seeker head automatically points toward the target. However, it is possible to lock up the target using only the AIM-9 seeker head using the boresight option. This is desirable if you have visually acquired a target and don't want to warn him of your presence via his RWR. By locking him with the IR seeker head only, he will have no warning of a lock.

To switch to boresight, press the button on the AIM-9 MFD that says "SLAV" to switch to "BORE." Next, set your radar to standby by pressing **(Ctrl) R**. Manually uncage the seeker head of an AIM-9 missile by pressing **(U)**. The diamond appears in the center of the missile reticle until a heat source is detected. As the heat source becomes more solid, you'll hear the tone rise in pitch and become louder as the diamond starts tracking the heat source. When you have a good lock, the tone turns into a steady high-pitched warble. Since you won't get distance data, a target locator line or a shoot indicator, you'll have to use your best judgment as to when to shoot the missile.

AIR-TO-AIR GUNS

Your F-16 is equipped with the formidable M61A1 20mm cannon. This Gatling-style gun shoots at an incredible rate of 6,000 rounds per minute. This is a dangerous close-quarters weapon and requires great skill to use effectively in air-to-air combat. The F-16 is loaded with 510 rounds of PGU-28 20mm bullets, which will be spent in about 5 seconds of sustained shooting. So shoot in short, controlled bursts.

In order to help you hit your target, there are three aiming displays you can use for air-to-air guns. They provide target solutions based on the target range, your velocity and your acceleration. However, the primary rule for lining up a target is to use the gun cross on the HUD to lead your target. Then use one of the gun sights below to refine your shot.

Once you've locked up a target on radar, all three gun submodes provide a digital range to target and closure rate readout in the lower right corner of the HUD. The top line displays the range in miles for targets greater or equal to 1 nm. For targets under 1 nm, it displays hundreds of feet.

The second line represents radar closure rate in knots. When there is no target locked up, the first line will read "M015." This stands for manual mode set to 1,500 feet, which is the default range setting for guns.

Select the different air-to-air guns submodes by first going into air-to-air guns main mode. Press until "EEGS" appears in the HUD mode indicator. Then cycle through the other two submodes, LCOS and SNAP, by pressing .

For more information on how to use your guns, see **Chapter 4: Air-to-Air Weapons**.

EEGS (Enhanced Envelope Gun Sight)

When you select EEGS, "EEGS" will appear in the HUD mode indicator. The EEGS adds a funnel, T-symbol, target designator and MRGS lines to the HUD display.





THE FUNNEL

The funnel pulls as you bank your aircraft, giving you a general indication of the path of bullets as if they were fired continuously. If you fired during a stabilized turn, the bullets would go down the center of the funnel.

The funnel is also used to judge distance to the target. The funnel assumes that the target is a fighter-sized target with a 35-foot wingspan. The minimum range, corresponding to the top of the funnel, is 600 feet. The maximum range, at the bottom of the funnel, is approximately 3,000 feet. If the target is smaller than the bottom of the funnel, it is out of range. To use the funnel, pull the funnel onto the aircraft and fire when the wings of the target just touch each side of the funnel.

THE T-SYMBOL

Once you've locked up a target, you'll see the T-symbol, which consists of a horizontal line and a small cross, along with a smaller tick. The cross is called the 1 G pipper and the small tick is called the 9 G pipper.

If you are turning in the same plane as your target, the 9 G pipper represents the firing solution if he is pulling 9 Gs. In other words, placing the 9 G pipper on the target while he is pulling 9 Gs in the same plane as you will provide the proper solution to allow you to hit the target. The 1 G pipper gives you the other extreme for the solution—pulling 1 G, which is flying straight and level. The area between these two pippers represents the linear range of 1 G to 9 Gs. If the target were pulling 4.5 Gs, for example, the solution would be exactly halfway between these pippers.

TARGET DESIGNATOR

The target designator for a locked target in EEGS is a square surrounded by a circle. A range gap, marked by a range tick, opens in the circle starting at the 12 o'clock position and extends counterclockwise around the circle. This range tick indicates the selected target's range from you in thousands of feet. For example, if the tick and gap are at the 9 o'clock position, the target is 9,000 feet from you. The maximum gun range is indicated by a dot on the circumference of the target designator. In *Falcon 4.0*, it is always fixed at 3,000 feet.

MRGS (MULTIPLE REFERENCE GUN SIGHT)

The multiple lines at the bottom of the HUD are used against high-speed targets at aspect angles from about 60° to 120°. Use them to line up with the target's motion. Each line is a reference such that a target continuing in its direction would end up in the funnel. The MRGS lines are not displayed when a target is locked, since they are designed for a high aspect snap shot when you do not have a radar lock.

LCOS (Lead Computing Optical Sight)

When you select LCOS, you'll see "LCOS" appear in the HUD mode indicator. LCOS provides a different set of aiming cues. They consist of a large circular reticle with the aiming reticle inside it and a target designator box.

AIMING RETICLE

The main aiming reticle is a circle with the gunnery pippier inside. A straight line connects the reticle with the gun cross. You want to have the gunnery pippier on the target when you fire the 20mm cannon.

Two additional cues appear on the reticle once you have locked up a target. One is the typical range cue, which is a tick mark that indicates thousands of feet. Its position on the circle corresponds with a clock value times 1,000 feet. For example, if it is at 9 o'clock, the target is 9,000 feet away.

The second mark is the closure caret on the inside of the circle.

The circle is divided in half, with

each side representing the clock values of 0 to 6 o'clock. The right side of the circle indicates positive closure values. The left side indicates negative closure values. The actual closure rate is the value (in knots) times 100. So, if the caret is at the 2 o'clock position, you have a closure rate of 200 knots. If it is at the 9 o'clock position, it represents a negative closure of 300 knots. The maximum closure it will display either positively or negatively is 500 knots (the 5 or 7 o'clock position). This closure rate is also displayed digitally under the target range readout in the lower right corner of the HUD.

A small line will occasionally appear to come out of the gunnery pippier. This line is the lag line, which shows the magnitude and direction of LCOS settling. The length of this line represents the degree of lag and the direction shows the direction the pippier is moving. When the firing solution has settled, the line will disappear.

TARGET DESIGNATOR

A locked target is shown with a standard TD box. If the TD box is out of the field of view of the HUD, a target locator line extends from the gun cross in the direction of the TD box.

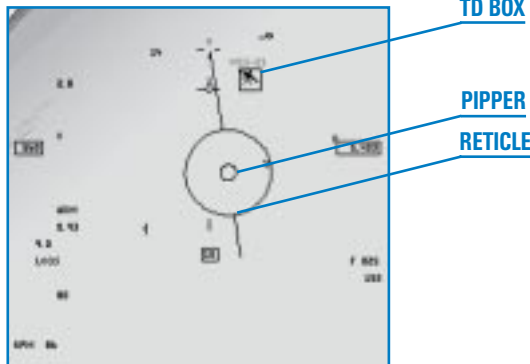



Snapshot Gun Mode

When you select the snapshot gun submode, you'll see "SNAP" appear in the HUD mode indicator. The snapshot submode provides a tracer line with tick marks and a TD box.



TRACER LINE

A straight line extends from the gun cross to the pippier. From the pippier, there is a floating, continuously computed impact line which shows where bullets would be if the gun was firing continuously. The three tick marks on this line indicate where a bullet would be if it had been fired $\frac{1}{2}$ second, 1 second and $1\frac{1}{2}$ seconds ago. Place the pippier over the target and fire.

TARGET DESIGNATOR

A locked target is shown with a standard TD box. If the TD box is out of the field of view of the HUD, a target locator line extends from the gun cross in the direction of the TD box.

DOGFIGHT MODE

Select Dogfight mode to quickly bring up your short-range weapons (gun and Sidewinder missiles). When you enter Dogfight mode by pressing **[D]**, your radar is set immediately to ACM mode (in Realistic Avionics mode). In addition, a special HUD mode (DGFT) displays a combination of the EEGS gun mode and a version of the SRM HUD mode. The HUD will display "NO RAD," indicating that the radar is not currently radiating.

You'll initially see the EEGS gunnery funnel and you'll hear the AIM-9 seeker head tone. When you do lock a target in dogfight mode, the TD circle appears with a diamond inside it. The TD circle also acts like the AIM-9 reticle that has been



slaved to the target. When the target draws within 12,000 feet, a range gap appears at 12 o'clock on the circle and opens up counterclockwise as the target gets closer.

In addition, once you've locked a target, you'll also see the DLZ display on the right side of the with the digital range-to-target display and the closure display under it.

Cancel the Dogfight mode by pressing **[C]** to return to the previous radar and HUD modes.

MISSILE OVERRIDE MODE

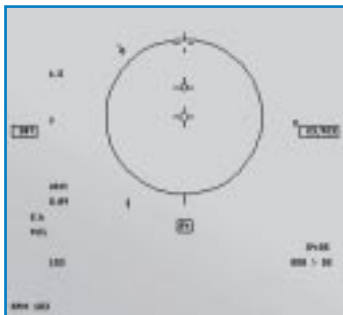

This special mode sets up a combination radar mode and HUD mode. When you select Missile Override mode by pressing **[M]**, you are put into RWS radar mode with the radar set to 20 nm range (in Realistic Avionics mode) and the MSL HUD mode, with AIM-120 or AIM-7 missiles selected. This gives you a quick way to handle medium-range threats without going through all the individual steps of radar and weapons selection.

Work with this mode as you would with the standard MRM HUD mode. There is no functional difference between the two modes.

Cancel the Missile Override mode by pressing **[C]** to return to the previous radar and HUD modes.

AIR-TO-GROUND WEAPONS

You have a large number of air-to-ground weapons to work with in *Falcon 4.0*: iron bombs, optically-guided missiles, laser-guided bombs, rockets, HARMs and your M61A1 20mm cannon.

Cycle through your air-to-ground weapon hardpoints by pressing **[Backspace]**.

There are basically two general types of weapons you'll use in air-to-ground attacks: iron bombs and guided missiles/bombs. Iron bombs are considered "dumb" devices and fall according to the laws of gravity and ballistics. Guided missiles and guided bombs are "smart" devices and can either steer or be steered to the target.

Dumb bombs can be turned into smart bombs. For example, the GBU-12B/B is just a dumb Mk-82 iron bomb with a laser spotter, some intelligence and steering added to it.

All the air-to-ground weapons have associated HUD modes that provide targeting cues. Some also have special MFD screens. We'll discuss bombs first followed by guided missiles, unguided rockets and the cannon.

For more information on your air-to-ground weapons, see **Chapter 5: Air-to-Ground Weapons**.



CCRP

CCRP (Continuously Computed Release Point) is the basic A-G (Air-to-Ground) submode you'll use for dropping bombs. There are really three submodes for bombs (CCRP, CCIP and Dive Toss), but since they all derive from CCRP, if you understand it first, the other two will make sense.

CCRP is used in conjunction with the GM radar mode for delivering weapons against preplanned targets. One of your steerpoints will likely be at or near a target of interest. When you engage the GM (Ground Map) radar mode, it will automatically lock up on one of these preplanned steerpoints. Fine-tune the target with the cursor controls.

Select CCRP by pressing `[Backspace]` until "CCIP" appears in the lower left corner of the HUD. Then cycle through the FCC (Fire Control Computer) submodes by pressing `[]` until "CCRP" appears in the lower left on the HUD.

When CCRP mode is called up in the HUD, you will see a number of HUD symbols that are used in CCRP bombing. Once you have locked onto a target with your radar and your target is visible within the HUD FOV (Field Of View), it will be marked with a TD box. Because you are selecting a target with the GM radar, you can easily select targets that are far beyond visible range. In some cases, depending on your position, the target will not be visible in the HUD. In this case, you'll see a target locator line that extends from the gun cross in the direction of the target.

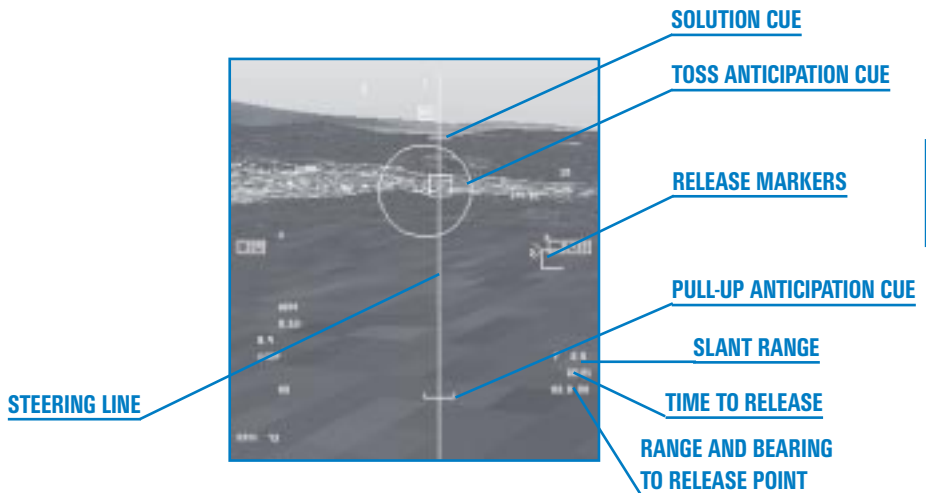

STEERING LINE

The main aiming cue in CCRP is the steering line, a long vertical line on the HUD. The steering line is used to keep you directly on line to your target. Fly your aircraft so that the flight path marker is always on top of the steering cue. This puts you directly on course to your preplanned target.

TOSS ANTICIPATION CUE AND SOLUTION CUE

CCRP has two other important cues: the toss anticipation cue and the solution cue. The toss anticipation cue is a circular reticle that appears two seconds before the solution cue appears. The solution cue appears when you are at the most distant position from which it is possible to hit your target. In order to hit the target at this distance (which is approximately 4 miles), you have to “toss” the bomb by pulling up the aircraft. This is covered in more detail under the Dive Toss submode. The toss anticipation cue lets you know that you are about 4 miles to the target.

The solution cue is a short horizontal line that crosses the steering line. As you near your target, the solution cue moves down the steering line to the flight path marker. At the point that it hits the FPM, you have reached your bombing solution.

In order to drop the bombs, you must establish a *consent* to release. Do this by pressing and *holding* the pickle button (Spacebar). Consent to release is a moment-by-moment affair. As long as you are holding the pickle button, you are telling the FCC that you are consenting to a weapons release when *it* has determined that you have reached the final bombing solution. At this point, as long as consent is still being generated, the FCC will release the weapon. It is important to understand that in CCRP mode, pressing the pickle button doesn't release the weapon as it does in other modes (such as CCIP), but merely gives the FCC your *consent* to release the weapon when the proper bombing solution is reached.

If you are holding the pickle button when the solution cue reaches the FPM, the steering line will move to the side of the HUD and the FPM will blink, indicating that the bomb has been dropped.

DIGITAL READOUTS

Three stacked digital readouts are displayed in the lower right corner of the HUD in CCRP mode. The first line is slant range to the target, in nautical miles. The second line is the time to release in seconds. This corresponds with the solution cue hitting the FPM. The third line shows the range and bearing to the release point. Range is in nautical miles and is displayed to the tenth of a nm. Bearing is in tens of degrees and indicates how many degrees you need to change your heading to reach a bombing solution. “35” (350°) tells you that the target is 10° to your left. “01” (10°) means the target is 10° to your right. Finally, the digits to the left of the gun cross represent the slant angle off the nose.

PULL-UP ANTICIPATION CUE

The pull-up anticipation cue is a HUD marker that is designed to warn you if you are likely to crash while coming in for a bomb run. The FCR places this cue, which looks like an inverted staple, on the HUD as you get close to the ground. Its job is to warn you when you have reached the minimum altitude for save dive recovery. As long as you keep the staple below the FPM, you will not crash. In addition, you will also see the word “LOW” displayed to the right of the FPM.



RELEASE MARKERS

On the right side of the HUD are several symbols that provide information about the weapons release. At the top is the range scale. This value is used to measure the range bracket below it. The top of the range bracket indicates the maximum release distance and the bottom of the bracket shows the level release distance.

A distance-to-target caret moves down the bracket as you approach the target. The full length of the bracket equals the distance displayed in the range scale. (For example, if the range scale equals 10 nm, the length of the bracket also represents 10 nm. A caret halfway indicates that the target is about 5 nm away.)

The number next to the caret represents the slant range distance to target in nautical miles.

While a target is typically selected for CCRP delivery based on a preplanned steerpoint, it is also possible to manually select a target by putting the GM radar into Snowplow mode (by pressing OSB-8 or pressing **Shift** **↑**). In this case, the radar scans ahead at the currently selected radar range. By manually slewing the cursors, you can lock onto any convenient target of opportunity.

Dive Toss

Very much like CCRP, Dive Toss mode differs mainly in that you visually identify the target rather than selecting a target with the GM radar. CCIP submode, described next, is also a visual method of dropping bombs. The advantage of Dive Toss is that it provides a way of delivering the weapon from the greatest possible distance. This is important if the target is heavily defended, since with CCRP or CCIP modes, you must fly over the target to drop the bomb. In Dive Toss, you lob the bomb at a 45° angle, which lobs it the greatest possible distance.

Select Dive Toss by pressing **Backspace** until "CCIP" appears in the lower left corner of the HUD. Then cycle through the FCC submodes by pressing **↓** until "DTOS" appears in the lower left on the HUD.

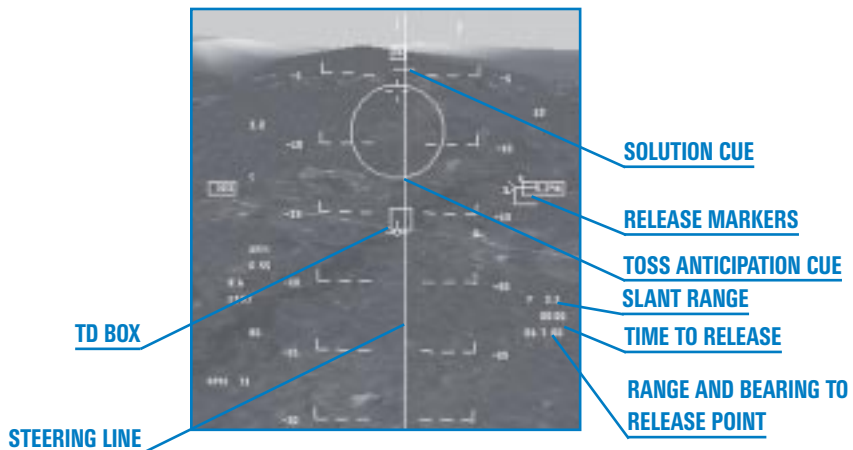

PREDESIGNATE

To use Dive Toss, you must see and designate a target. Do this by steering the aircraft so that the TD box, which is initially on the FPM, is on the target; then press the pickle key (Spacebar). This ground-stabilizes the TD box.

POST-DESIGNATE

Once the target has been designated, you end up with a HUD display that looks very much like the CCRP HUD mode. Use the vertical steering line to determine the proper azimuth steering to the target. Fly the aircraft so that the FPM stays on the steering line.

The difference for Dive Toss is that at the moment that the solution cue appears, you pull your aircraft into a 4 G, 45° climb. This has the effect of moving the FPM to the solution cue rather than waiting for the solution cue to drop down to the FPM. The FCC assumes that you will go into a 4 G pull-up within two seconds of the solution cue appearing.

When the solution cue hits the FPM, assuming you have given consent by pressing and holding the pickle button, the FPM will flash and the bomb will be tossed to the target. The distance the bomb can travel is directly a function of the climb angle you initiate. By pulling up to a 45° angle, you can toss the bomb its maximum distance. If your angle is lesser or greater than 45°, your bomb will not travel as far. The FCC will still compute the proper solution and will still release the bomb at the time the cue hits the FPM, but you will not get maximum loft.

Since the timing for this maneuver is fairly critical, pay attention to the toss anticipation cue that appears two seconds before the solution cue. The toss anticipation cue is the flashing circular reticle. It lets you know that the solution cue is about to appear, so you can get ready to start your 45° pull-up.

CCIP

CCIP (Continuously Computed Impact Point) is a method of visually dropping iron bombs. Select CCIP by pressing (Backspace) until "CCIP" appears in the lower left corner of the HUD.

CCIP HUD mode displays three main aiming cues: the bomb line, the delay cue and the piper. The bomb fall line starts at the FPM and extends down the HUD ending in the aiming piper. The piper shows the spot where your bomb would impact if you release it at any given moment. It is a continuously computed impact point, as the name of this submode suggests.

There are two methods of CCIP bombing: manual pickle and FCC.

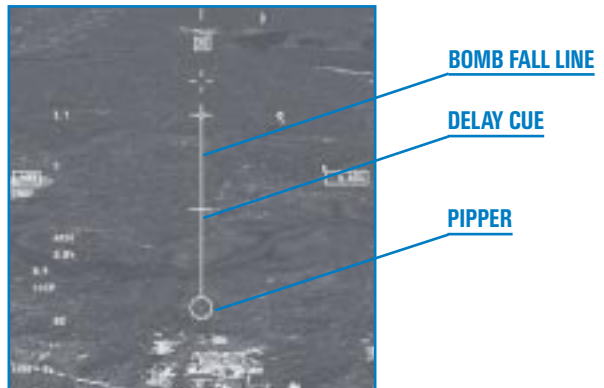



MANUALLY PICKLING

Line up your target with your flight path marker just above the target. Keep the bomb line running through the target. Pitch down at least 5°. At some point, the delay cue will disappear and the target will move down the bomb line until it is under the piper. Pickle the bomb (Spacebar) when the piper is on the target.

You should immediately egress out of the area by banking to the side at least 60°, pulling at least 5 Gs, or else you're likely to get hit by your own bomb blast.

FIRE COMPUTER CONTROL

Line up on the target and, when the piper is over the target, press and hold the pickle button. If you do this while the delay cue is visible, the bomb line will be replaced by the CCRP steering line. Fly so that you keep the FPM on the steering line. The steering line will eventually move quickly to the side of the HUD as the fire solution is reached. When it moves back to the center, your bombs will be automatically released by the FCR.

The HUD symbols and readouts are the same as in the CCRP HUD mode.

Ripple, Interval and Single/Pair

When you release iron bombs using any of the three modes described above, you can also select a number of parameters that determine the number of bombs dropped and how they are released. These options are available in the A-G MFD screen (and via keyboard commands).

RIPPLE

The Ripple setting lets you select one, two or three bombs to be dropped in sequence. Press OSB-10 next to the "RP" label to cycle through the ripple choices. You can also cycle through these choices by pressing Shift ; or Shift '.

INTERVAL

You can modify the dispersal results with the Interval setting. Rather than releasing bombs all at once, the bombs are rippled a specific intervals, making them hit the ground at fixed distances apart. Use this if, for example, you want to bracket a building with Mk-84s rather than having them all hit the building at the same spot.

Choose from 25, 50, 75 and 100 feet distances with the ripple interval setting. Select the interval distance by pressing OSB-9 or press Ctrl ; or Ctrl '.

SINGLE/PAIR

This toggles the bomb release mode from releasing a single bomb to releasing symmetrical pairs of bombs. Toggle between single and pairs by pressing Alt ; or Alt '.

Types of Bombs Available

Falcon 4.0 has a fairly wide assortment of iron bombs available. In all cases, the HUD modes for bombs will operate the same regardless of which bomb you are using. When you select a bomb from the SMS (Stores Management System), its ballistic data is loaded into the FCC and this information is automatically used in the calculations for the various solution cues.

Below is a quick overview of the various kinds of bombs you'll use in *Falcon 4.0*.

MK-20 ROCKEYE

The Mk-20 (pronounced "Mark 20") Rockeye is a canistered munition, meaning it opens at a predetermined height and releases a quantity of submunitions. The Rockeye is primarily used as an anti-tank cluster bomb, although it is also very effective against soft targets. It contains 247 shaped-charged antitank bomblets. The bomblets free-fall over a 3,250 square yard area and detonate on impact.

MK-82

The Mk-82 (pronounced "Mark 82") is a basic 500-lb. iron bomb that produces blast and fragmentation damage.

BSU-49

The BSU-49 is a high-drag version of the Mk-82 that's used for low-altitude bombing. The high-drag keeps this bomb from hitting until after your aircraft has passed over the target and is away from the blast radius.

MK-84

The Mk-84 is a 2,000 lb. bomb, capable of destroying small to medium-sized buildings and bunkers.

BSU-50

This is a high-drag version of the Mk-84 bomb.

BLU-109/B

This is an improved version of the Mk-84, with a casing that is twice as thick. It is capable of penetrating hardened targets.

BLU-107/B

The BLU-107/B Durandal is a runway penetration bomb used for cratering runways. A general purpose bomb like the Mk-84 will leave a nice crater in the middle of a runway, but this crater is easily filled in with a bulldozer and patched. In contrast, the Durandal's small rocket motor drives it beneath the runway surface before it explodes, thus buckling the concrete slabs around the blast area. Not only does the Durandal blast affect a larger area, the damage takes longer to repair since the buckled concrete must be excavated before the hole can be patched.



CBU-52B/B

All the munitions named “CBU” (Cluster Bomb Unit) are cluster munitions holding a variety of submunitions. The CBU-52/B contains 200 softball-sized submunitions that are effective against soft-skinned targets such as personnel or lightly-armored vehicles.

CBU-58A/B

This cluster munition is optimized for killing soft-skinned targets such as personnel and lightly-armored military vehicles. The dispenser holds 650 baseball-sized bomblets which are dispersed over a wide target area.

CBU-87 CEM (COMBINED EFFECTS MUNITION)

The CEM dispenses 202 bomblets over an area 800 feet by 400 feet. It is used as an area denial cluster weapon. This weapon is optimized against both lightly armored vehicles and personnel. The CBU-87 was used extensively for interdiction during the Gulf War.

CBU-89/B

The CBU-89/B belongs to the Gator family of scatterable mines. Its dispenser holds 72 anti-armor munitions and 22 anti-personnel munitions. These munitions arm immediately upon impact. The Gator uses two separate detonation mechanisms. It has a magnetic proximity fuse that senses armored vehicles and explodes when they are nearby. It also deploys trip wires that are sensitive to movement by personnel.

ROCKET LAUNCHER

Your F-16 can carry a LAU-5003A rocket launcher pod. It launches small, 2.75-inch folded-fin aerial rockets (FFARs). These unguided rockets are effective against light armor, vehicles and other soft targets. The launcher holds 19 rockets and fires all 19 at one time.

When you call up the LAU-5003A, you’ll see “RCKT” appear in the HUD mode indicator. A small circular reticle appears in the HUD, which shows the point of rocket impact if you launch the rockets at any given moment. Be aware that the rockets launch in sequence and that it takes some time to cycle through all 19 rockets. If the reticle is moving, the rockets will not all hit the initial spot the reticle was pointing at the time of launch.

Cycle through your air-to-ground weapons until you see “RCKT” in the HUD mode indicator. Place the pipper on your target and press the weapon release button. For more information on how to use rockets, see **Chapter 5: Air-to-Ground Weapons**.

RETICLE



MAVERICK AGM-65 MISSILE

The Maverick is an AGM (Air-to-Ground Missile) designed for close air support, interdiction and suppression of enemy air defenses. It is particularly effective against tanks and other vehicles as well as tactical targets like fuel storage facilities. Its long range and accuracy make it a good stand-off weapon. The Maverick is considered a “fire-and-forget” weapon because, once you lock onto a target, the missile will track to the target independent of what you may be doing. This allows you to make evasive maneuvers or lock onto other targets without having to worry about the launched missile.

Mavericks can be launched anywhere from high altitudes to treetop level and can hit targets ranging from a distance of a few thousand feet to many miles. U.S. Air Force F-16s and A-10s employed AGM-65 missiles in 1991 to attack armored targets in the Persian Gulf during Operation Desert Storm.

Three versions of the Maverick are available in *Falcon 4.0*: the AGM-65B, AGM-65D and AGM-65G.

Maverick Model B uses an electro-optical television guidance system. Once the missile is activated, the scene viewed by the guidance system appears on one of the cockpit MFDs. The AGM-65B contains a screen magnification capability that allows you to identify and lock onto smaller and more distant targets visually. This model is designed for daytime use in clear weather.

The Maverick Model D uses an infrared imaging guidance system. It operates like the AGM-65B but is capable of working at night or during adverse weather conditions. The infrared-sensing AGM-65D can track heat generated by a target and provide a clear display of the target during darkness and inclement weather.

The Maverick Model G is basically the same as the D model but is optimized for heavier targets. It contains a 300 lb. heavyweight penetrator warhead, as opposed to the 125 lb. shaped-charge warheads of the B and D models.

The Mavericks are used in combination with the MFDs. In some cases, you’ll lock onto targets with the GM radar mode. In others, you’ll visually select targets. However, in each case, you’ll use the EO (Electro-Optical) display on the MFD to track your target and make fine adjustments. For more information on how to use Mavericks, see **Chapter 5: Air-to-Ground Weapons**.

There are two HUD submodes for using Maverick missiles: boresight and slave.



Boresight Submode

The boresight submode is a visual acquisition mode, meaning you acquire your target visually by placing the TD box in the HUD over the target.

To get into boresight mode, press **[Backspace]** to cycle through the air-to-ground weapons until you see “BSGT” in the lower left corner of the HUD. You will see a small square TD box appear over the flight path marker. Turn on one of your MFDs and cycle through it until you see the SMS (Stores Management System). If the SMS is on the Inventory page, cycle SMS pages by pressing **[;]** until it displays the weapons page. This activates the EO system on the Maverick and feeds the data to your MFD, where it will be displayed as a video image.

TD BOX

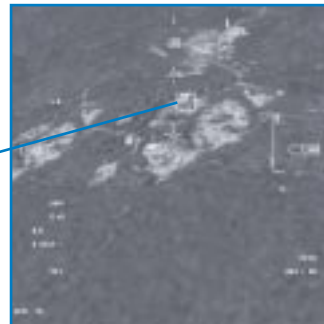

Use **[↑]**, **[↓]**, **[←]** and **[→]** or steer the aircraft to move the TD box until it is over your target and designate the target by pressing **[0]** on the numeric keypad. This ground-stabilizes the Maverick. Then use **[↑]**, **[↓]**, **[←]** and **[→]** to fine-tune your aim.

When the Maverick “sees” the target, a dashed box will start “breathing” on the MFD. Your arrow keys are active and you can move the seeker head around to another target. However, if the Maverick hasn’t “acknowledged” the target, the dashed box will disappear. You’ll also see a pointing cross that indicates where the AGM-65 seeker head is pointing with respect to the missile centerline.

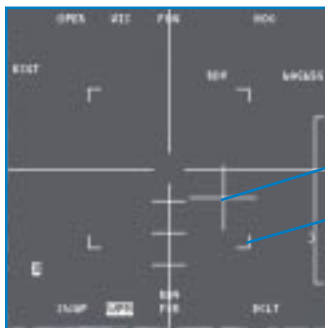

POINTING CROSS

DASHED BOX

Once you pick the target you want (it must be within the dashed box), designate once more to lock the target. The dashed box will shrink to its smaller size, indicating the target is locked. You can now fire the Maverick by pressing the pickle button. To clear the lock so you can select a new target, press **[.]** on the numeric keypad.

After you fire the missile, the dashed box (which is still centered on the last target) starts breathing again, which allows you to slew the seeker head and lock onto another nearby target. For example, you can target one end of a bridge, fire a Maverick, slew to the other end of the bridge, and lock and fire another Maverick.

Note that in Easy Avionics, only the slave submode of the Maverick missile works.

LOCKED TARGET

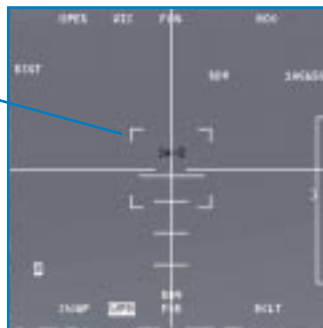

Slave Submode

In Slave submode, the Maverick is used in conjunction with the GM or GMT (Ground Moving Target) radar. You lock a target on radar and the FCR (Fire Control Radar) tells the Maverick to look at the locked target.

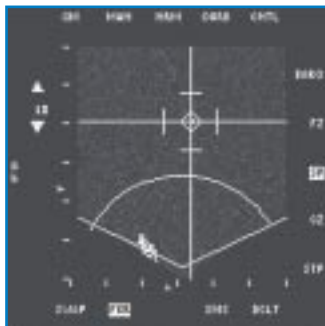

With the Maverick selected (BSGT mode), press to cycle through the FCC submodes until the HUD mode indicator reads "SLAVE." Set up one of your MFDs as you did for boresight mode.

Set your other MFD to radar mode, and then select either GM or GMT radar mode by pressing . Move the radar cursors over the target with , , , and and then designate the target by pressing on the numeric keypad.

Once you lock up a ground target, a small diamond will appear over the selected target and the Maverick TD box in the HUD will automatically slave to the target that your radar has locked up. Press on the numeric keypad to break lock if you need to reestablish the lock or to lock a different target. Then fire the weapon () to launch the Maverick.

When you fire a Maverick missile, the EO display will continue to display the target as long as you have additional Mavericks onboard. The next Maverick missile's seeker head will be automatically locked to the target and will continue tracking the target on the EO display. When you fire your last Maverick missile, the EO display will go blank.

In Easy Avionics, press to lock onto the next ground target. Once you lock onto a target with the radar, the Maverick automatically locks onto the same target. Buildings appear as medium-sized squares and vehicles appear as small squares. The ground targets are color-coded red for enemy, blue for





friendly and green for neutral. The word “SHOOT” will flash in the HUD when the Maverick is locked on and has a good chance of hitting its target.

GUIDED BOMB UNITS

GBUs (Guided Bomb Units) are highly accurate laser-guided bombs. They are dropped like iron bombs but are then guided in flight to their targets by locking in on a laser designation that illuminates the target from the laser designator on your aircraft.

The gimbal limits of the laser designator, while flying straight and level, are approximately 60° right and left, 30° behind and 120° in front of you. After releasing your GBUs, you must keep the target in such relationship to your aircraft that the designator doesn't exceed these limits. Otherwise, the bomb will not be guided to its target. Generally, you want to start a gentle bank to the right or left after releasing your ordnance. For more information on how to use GBUs, see **Chapter 5: Air-to-Ground Weapons**.

GBU-10A/B Paveway II

The GBU-10A/B Paveway II is based on the Mk-84 2,000 lb. iron bomb. The GBU version has a semi-active laser homing seeker, canards on the nose and tail section, and control surfaces on the rear end. When the homing seeker locks on, it commands the control surfaces to guide it directly to the target. It can operate in cloud ceilings down to 2,500 feet.

GBU-12B/B Paveway II

The GBU-12B/B is the smaller version of the GBU-10A/B. It is based on the smaller Mk-82 500 lb. bomb and is a guided version of the same weapon. It operates like the GBU-10A/B.

GBU-24/B Paveway III

The GBU-24/B is a third-generation GBU and contains a penetrating warhead. It can be effectively employed at low, medium or high altitudes. The Paveway III uses semi-active laser homing to guide to its target, and has improved stability and performance. The bomb weighs 2,306 pounds and is approximately 14 feet long.

GBU Submodes

Like the Maverick missile, the GBUs can use either boresight or slave submodes.

BORESIGHT MODE

Select boresight mode by first selecting LGBs (Laser-Guided Bombs) as the current weapon. Bring up the SMS page on an MFD. Use **[Backspace]** to cycle through the A-G weapons. It should show an EO display with the GBU in boresight mode. If it is in slave mode, switch to boresight by pressing OSB-20 or press **[]** to cycle through the FCC submodes.

In boresight mode, you'll see a TD box superimposed over the FPM in the HUD. Fly the aircraft until the TD box is positioned over the intended target and then designate the target by pressing **[0]** on the numeric keypad. Once you designate the target, you can fine-tune the position of the TD box by using **[↑]**, **[↓]**, **[←]** and **[→]**.

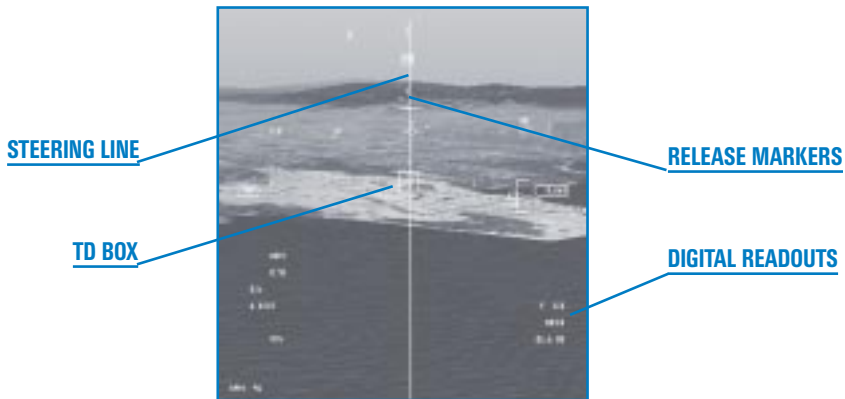

When you designate a target, a large box appears around the target in the EO MFD. In addition, you'll see a pointing cross that indicates where the seeker head of the LGB is looking in respect to the bomb centerline. The three tick marks on the lower cross hairs each represents 5° of deflection.

Fine-tune the TD box until the large square in the MFD starts "breathing." This means that the onboard laser designator pod has identified a target. If you designate again (**0** on the numeric keypad), the seeker head locks onto the target. The square will shrink to its smallest size around the target.

The release procedure for an LGB is the same as it is for an iron bomb in CCRP mode. The HUD display is likewise the same as for CCRP.

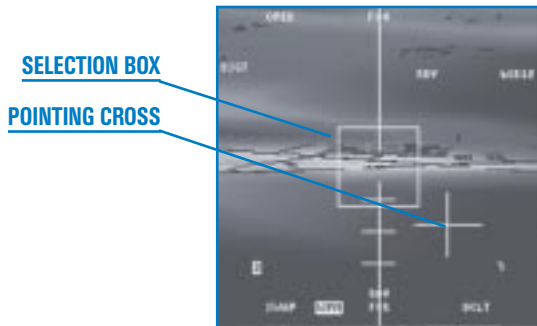

LGBs cannot be set to ripple, for interval or to release in single vs. pair. You must pickle off each bomb independently. You can, however, manually release multiple bombs.

Note that in Easy Avionics, only the slave submode of GBUs is operational.



SLAVE MODE

Select slave mode by first selecting LGBs as the current weapon. Bring up the SMS page on an MFD. Use **[Backspace]** to cycle through the A-G weapons. It should show an EO display with the GBU in boresight mode. To switch to slave mode, press OSB-20 or press **[]** to cycle through the FCC submodes.

Slave mode is used in conjunction with the GM or GMT radar modes. If a target has been programmed in as a steerpoint, it will already be selected in GM radar mode. You can also go to GM Snowplow mode by pressing **[Shift][↑]** and select any target that appears on the radar.

Once a target is selected on radar, the LGB seeker head is automatically pointed to the locked target and appears in the EO display on the MFD surrounded by a large box. In addition, you'll see a pointing cross that indicates where the seeker head of the LGB is looking in respect to the bomb centerline. The three tick marks on the lower cross hairs each represents 5° of deflection.

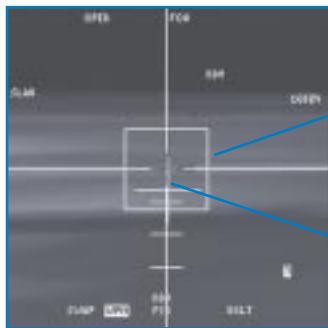
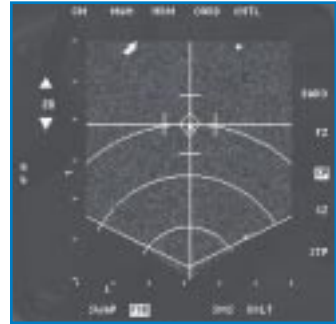

TRACKING BOX

POINTING CROSS

As you near the target, you can fine-tune the lock with **[↑]**, **[↓]**, **[←]** and **[→]**. When the seeker head has identified a target, the large square in the MFD starts "breathing." If you designate again, the seeker head locks onto the target. The square (or tracking box) will shrink to its smallest size around the target.

The release procedure for an LGB along with the HUD display is the same as it is for an iron bomb in CCRP mode.

In Easy Avionics, the targeting pod of the GBU automatically locks onto whatever target is locked up in the air-to-ground radar.

AGM-88A HARM

The AGM-88 HARM (High-Speed Anti-Radiation Missile) is used against air defense installations. This missile, combined with the F-16's onboard avionics, detects, identifies and locates enemy radars, displays threat information and computes target parameters. The HARM is designed to operate in two basic modes: self-protect mode (attacking targets that pose immediate threat to the aircraft) and pre-brief mode, where the missile is programmed to the vicinity of known or expected targets, and attacks when lock-on is achieved.

Bring up the SMS page on an MFD. Press **[Backspace]** to cycle through the A-G weapons until you see "HTS" displayed. The MFD shows a circle or a broken circle. A circle shows the area of detection in front of your plane. A broken circle indicates that the detection range is beyond the current display range on the scope. You will also see your flight plan. Preplanned threats are shown as dimmed symbols. Radiating threats are shown as numbers in flashing inverse video. The numbers (2, 3, 4, 5, etc.) correspond to that SAM type. For example, if you see a "2" on the MFD, it means an SA-2. "A" stands for AAA guns, "P" for Patriot, "C" for Chaparral, "H" for Hawk and "N" for Nike/Hercules. For information on these weapons, see **Tactical Reference** in the game.

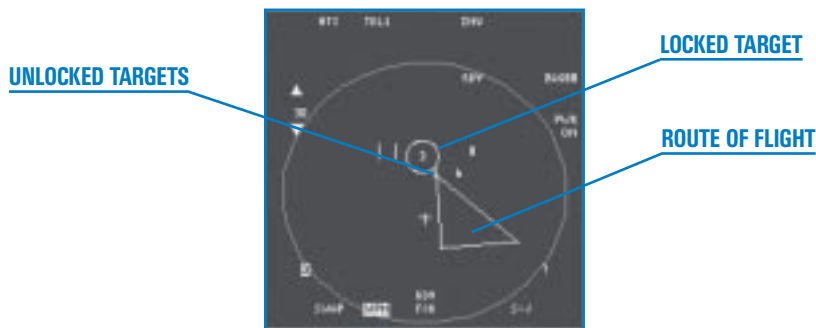

Move the cursors over a numbered target and designate by pressing **[0]** on the numeric keypad. A small circle is drawn around the locked target.

Increase the range for the display by pressing OSB-19 or **[F11]**. Decrease the range by pressing OSB-20 or **[F12]**.

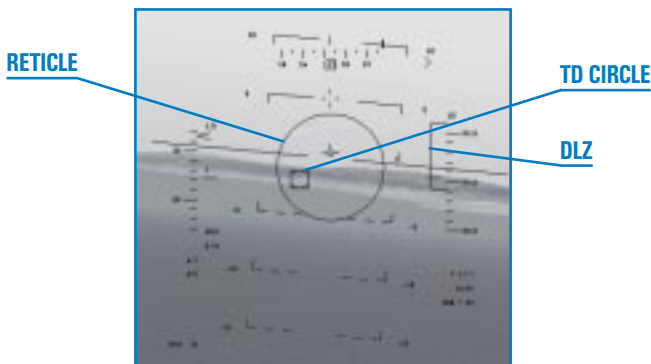



When you call up HARMs, the HUD mode indicator reads “HTS” (HARM Targeting System). A circular aiming reticle appears in the center. This reticle provides aspect angle and distance ranging cues just like the AIM-9 HUD mode. The HTS HUD mode also includes a DLZ, which gives additional distance information.

When a radiating ground threat has been locked up in the HTS MFD screen, a circular TD appears over the target in the HUD. If the target is out of the field of view of the HUD, a line is drawn from the gun cross to the edge of the HUD in the direction of the target.

Once a target is locked up, you can fire the HARM by pressing the pickle button (Spacebar). For more information on how to use HARMs, see **Chapter 5: Air-to-Ground Weapons**.

AIR-TO-GROUND GUNS

Your 20mm cannon is an effective air-to-ground weapon against certain kinds of targets, especially lightly armored vehicles. Its range is limited so you won’t have a lot of time to line up your target and fire. Be sure not to become so intent on hitting your target that you plow right into it.

Select the A-G gun HUD mode by cycling through the A-G weapons. Press Backspace to cycle through your A-G weapon modes.

When the HUD mode indicator reads “STRF” (Strafe), you have selected the M61A1 for air-to-ground gunnery. The A-G gun reticle is a small circular piper. It effectively describes a continuously computed impact point of bullets if you fire the gun at any given moment.

PIPPER WITH HAT

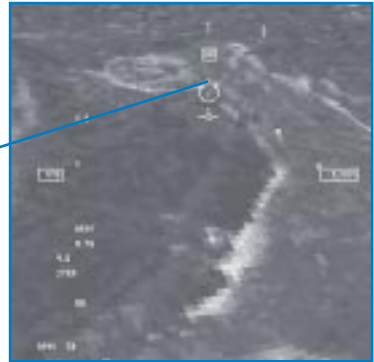

The FCC takes into account your altitude and dive angle to compute the slant range to your target. When you are in firing range (range for guns is about 8,000 feet), the circular piper displays a horizontal bar (hat) over the piper.

To use the guns, put the piper on your target, wait for the hat to appear, and fire away. You should fire in short, controlled bursts rather than in one long continuous burst. Your cannon can go through its store of rounds very quickly.

If you are firing at a moving target that is traveling across your field of view, you will have to “lead” the target by placing the piper in front of the target and watching where the tracers hit. Fire a small burst, make small adjustments as needed, and fire another small burst until you are properly tracking the target.

RECONNAISSANCE POD

The TARS (Tactical Aerial Reconnaissance Pod) is used for both recon and BDA (Battle Damage Assessment) missions. TARS does not provide any feedback to the pilot on the picture quality until after landing. You just have to fly the mission and take your chances.

For recon missions, you must fly over the target with the TARS pod and place the target under the 8° pipper in the HUD. When the target is in the pipper, press the pickle button to take the picture. For a BDA mission, the pilot must reach the target *after* the bombs fall to take a picture of the damage. Since the TARS has a digital camera that is always running when the plane is off the ground, it is important to mark the film or else you will not get credit for a successful mission.

Call up the TARS pod in the same way as other air-to-ground modes. Bring up an air-to-ground weapons MFD page by pressing **[F10]** or **[F11]**. Then press **[Backspace]** until you see "RPOD" at the top of the MFD. When the 8° pipper (the big circle 8° beneath the gun cross) appears in the HUD, you are ready to take pictures. The pipper is situated beneath the gun cross so you don't have to point your nose at the target in order to take a picture of it. When you press the pickle button (**[Spacebar]**), the TARS takes a picture of whatever is inside the pipper. You need to be within 2 miles of the target for a good shot.

PIPPER

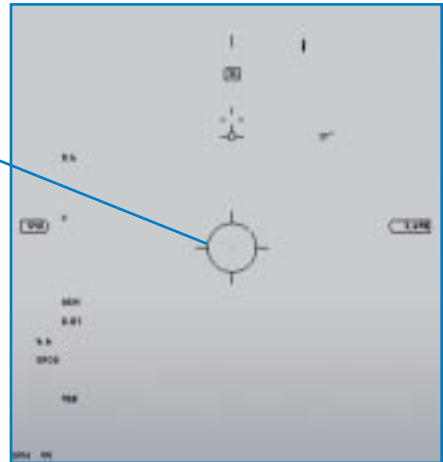



ILS

The ILS (Instrument Landing System) helps you line up your approach to airbase runways, particularly at night or in heavy clouds. Every airbase (although not airstrips) will have at least one active ILS system. You must approach the runway from the proper direction for the ILS beacon to be effective. Contact the tower by pressing **T** and radio, “Inbound” to get your vector to the airbase runway.

ILS BARS

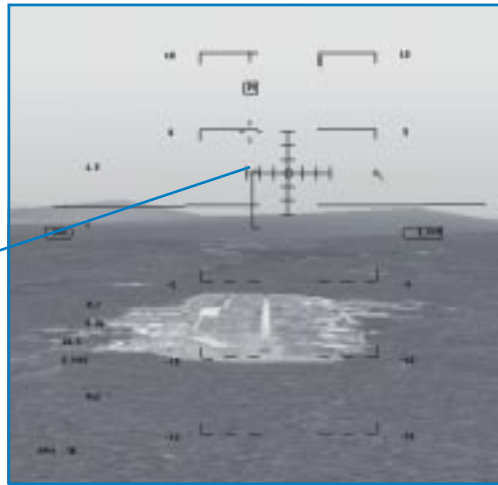

Set up the ILS HUD mode by pressing **V** to cycle through the navigation modes. Look for “ILS” in the HUD mode indicator. In the center of the HUD itself, you’ll see intersecting horizontal and vertical lines. These are your glide slope and localizer deviation bars. The glide slope deviation bar is the horizontal bar that tells you if you are on the proper glide slope. The localizer deviation bar is the vertical bar that lets you know if you are properly lined up with the runway.

When you are not properly oriented toward the ILS beacon, the glide slope and localizer deviation bars are dashed, indicating that they are invalid for providing useful information.

Once you are in the correct orientation, the bars will be solid. In order to position yourself on the proper flight path for landing, fly in the direction of the intersection of the bars. For example, if both bars intersect at the bottom right, you need to descend to your right. As you line up with the runway, the bars should form a cross in the center of your HUD. Place the flight path marker at the start of the runway to land at the right spot.

For detailed instructions on landing, see **Chapter 3: Landing and Navigation**.

HUD CONTROLS

You can control what is displayed on the HUD. For more details, read “HUD Control Panel” in **Chapter 17: The Consoles**.

Press **H** to declutter the HUD. The first time you press **H**, the pitch ladder is removed. The second time you press the key, the flight path marker is removed. The third time you press **H**, the HUD is restored to its original state.

Press **Ctrl H** to flip the scales switch. The first time you press **Ctrl H**, the altitude and airspeed are displayed as discrettes. The second time, they are displayed as moving tapes. Pressing **Ctrl H** a third time brings up both the tapes and discrettes.

Press **Alt H** to cycle through the available colors for the HUD.

EASY AND SIMPLIFIED AVIONICS

If you selected Easy or Simplified Avionics in the Simulation setup, your HUD display is simplified. Specifically, altitude and airspeed will be displayed in discrettes (not tapes). In addition, you will not see the pitch ladder unless your nose is 20° above or below the horizon. The HUD will display a “SHOOT” cue when the target is inside the no-escape zone and it is time to fire the missile.

CHAPTER

19



THE MFDS

The MFDs (Multifunction Displays) are two CRT-based displays that sit in the front of the cockpit. They are used primarily to display weapons system management functions—in particular, weapons stores information, radar information and weapons electro-optical displays. The MFDs are also used to display HUD, RWR and navigation information.

The MFDs provide an integrated method of accessing the data required to perform a mission. Having all this information available in a single system is very useful, but don't let the MFDs become "face magnets." If you spend all your time looking at the MFDs, you're going to miss some bad guy out there.

Because the F-16 is an integrated weapons platform, you'll find that the MFDs are used in tight conjunction with the HUD and the ICP. Weapons modes that are called up on the MFDs have corresponding HUD mode displays (which were discussed in the previous chapter). Navigation and steerpoint changes are set via the ICP (which is discussed in the next chapter).

OPTION SELECT BUTTONS

The MFD set consists of two CRTs surrounded by buttons, known as OSBs (Option Select Buttons). There are five buttons per side, making a total of 20 buttons per MFD. OSBs are used to select various options which are displayed as dynamic button labels (sometimes called mnemonics) around the edges of the MFD.

These buttons are numbered and arranged in the following order:

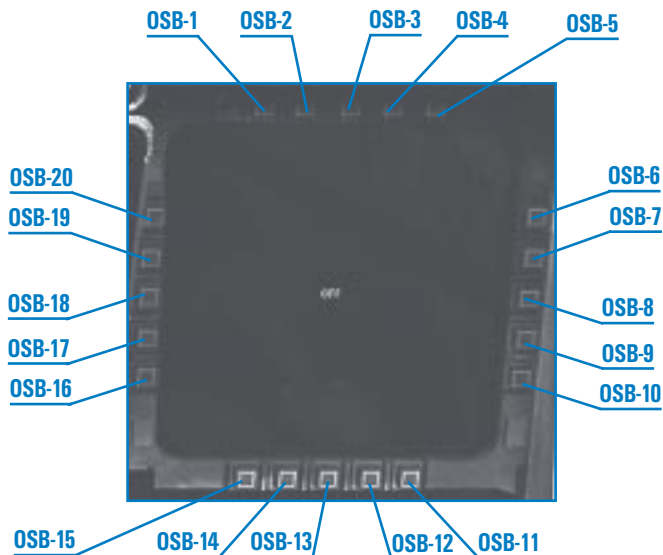



The OSB function depends on the MFD page you are on and the labels, if any, associated with a button. In general, however, the OSBs along the bottom of the displays control the selection of the main display systems. The OSBs along the top of the display control the submodes, and the OSBs along the sides are used to select options unique to each mode.

In the HUD Only view, you can show up to four MFD displays simultaneously. Press **[L]** and **[R]** to put MFDs in the lower left and right corners of the display. Press **[Shift+L]** and **[Shift+R]** to put MFDs in the upper left and right corners of the display.

Note that if you are in the 2-D Cockpit view, you will not be able to click on the OSBs directly.

MFD PAGES

There are MFD pages for the HSD (Horizontal Situation Display), the FCR (Fire Control Radar) and the SMS (Stores Management System). Each of these main systems has submode pages that provide information and options for the main modes. There are also redundant MFD displays for the RWR (Radar Warning Receiver) and the HUD (Head-Up Display).

When a page is selected, the label for that page is highlighted at the bottom of the MFD. For example, on the main menu page, the word "MENU" is highlighted at the bottom.

MAIN MENU PAGE

The Main Menu page is the first MFD page to appear when you turn on the MFD. Cycle through MFD pages in the 2-D Cockpit view by pressing **[L]** for the left MFD and **[R]** for the right MFD. When the MFD is off (it will say "OFF"), press one of these keys to cycle the MFDs through the following pages: Main Menu page, HSD page, FCR page, SMS page, RWR page, HUD page and MFD off.

These main MFD pages can also be selected by pressing the associated labels for them on the Main Menu page.

HSD PAGE

The HSD page displays a very useful navigation tool called the Horizontal Situation Display. This page graphically shows your current steerpoint route laid out with each steerpoint marked by a small circle. Since the display orients to your heading, it is easy to fly to a given steerpoint by simply turning to put the steerpoint at the top of the display. From the Main Menu page, click OSB-2 to access the HSD page.





On the HSD page, you have the following OSB labels:

OSB-3 NORM. Not used in *Falcon 4.0*.

OSB-5 CTRL. Not used in *Falcon 4.0*.

OSB-12 SMS. Switches to the SMS main page.

OSB-14 HSD (highlighted). Returns to the Main Menu page.

OSB-15 SWAP. Swaps the left and right MFD displays.

OSB-19 Down arrow. Decreases the HSD range scale (**F11**).

OSB-20 Up arrow. Increases the HSD range scale (**F12**).

Ownship Indicator

The ownship indicator looks like a plane icon or an oversized “+” in the bottom center of the HSD that indicates your position. It always remains in the same position on the display, and all the steerpoint and route information revolve around the display in relation to your position.

Range Scale

The range scale appears in the upper left of the MFD bracketed by up and down arrows. The scale setting determines the range scale for the display which can be 15, 30, 60 or 120 nm. To change the range, use either the OSBs next to the arrows or **F11** and **F12** to decrement or increment the range respectively. The range scale does not wrap around when it reaches either limit.



Range Rings

The three rings around your ownship indicator are used to judge range to the various steerpoints. Each ring represents one-third of the range scale setting. So if the range scale is set to 60 nm, each ring represents 20 nm.

Navigation Route

The main element on the HSD is your navigation route. This consists of your steerpoints connected by straight lines. The number of steerpoints and amount of the navigation route you can see depends on the position of the steerpoints in space and, more importantly, the range scale setting for the HSD. If you expand the range, you'll see more of the navigation route.

The currently selected steerpoint (which is the steerpoint selected in the DED) is shown as a blinking circle on the HSD.

As you change headings, the nav route moves around the HSD in relation to the front of your aircraft, as shown by the ownship indicator.

A-A and A-G Ghost Cursors

These cursors show the position of the A-A (Air-to-Air) and A-G (Air-to-Ground) cursors overlaid on the HSD screen, showing you where these cursors are aimed in relationship to your flight plan. The ghost cursors look like their radar counterparts. Note that you cannot move the ghost cursors directly on the HSD because this display is never the sensor of interest.

FLOT

The FLOT (Forward Line of Troops) is the long segmented line that runs across the HSD. The FLOT represents your best intelligence at takeoff and it may be inaccurate. See **Chapter 27: Mission Planning and Execution** for more information.

Bullseye Information

You will see three bullseye readouts on the HSD screen. A small bullseye graphic, which looks like a small circle, indicates where the bullseye is actually located. The number inside the bullseye circle is your range to the bullseye, and the number below the circle is your bearing from bullseye. The bearing *from* bullseye is an absolute reference to bullseye regardless of your heading. The arrow on the circle points towards the bullseye relative to your nose. In addition, at the bottom left of the screen is a readout indicating your bullseye position at any given time.

The second bullseye readout appears on the left of the HSD. It indicates the bullseye position of your radar ghost *cursors*. The first number is bearing and the second number is your range. As you move your radar cursors, the bullseye value changes because you are moving the cursors through space.

You can find further details on using bullseye in **Chapter 21: The Radar**.

FCR PAGE

The FCR (Fire Control Radar) page is accessed by pressing OSB-3 from the Main Menu page. You are in the FCR page when “FCR” is highlighted at the bottom of the MFD.

In the FCR page, you select your radar modes. In Easy avionics settings, you only have two modes: air-to-air and air-to-ground. Simplified avionics setting adds an ACM mode. With the Realistic avionics setting, you have seven radar modes: four air-to-air modes (RWS, VS, TWS and ACM) and three air-to-ground modes (GM, GMT and SEA).

Cycle through the A-A modes by pressing **[F1]**. Cycle through the A-G modes by pressing **[F2]**.



FCR

At the bottom of all the Realistic radar modes, you’ll see “SWAP,” “FCR,” “SMS” and “DCLT.” SWAP is used to swap the left and the right MFD displays. If you press the FCR button while it is highlighted, you will return to the Main Menu page. SMS switches to the SMS page. DCLT (Declutter) is not used in *Falcon 4.0* since the radar is already in declutter mode.

These radar modes and their associated MFD pages are described in **Chapter 21: The Radar**.

SMS PAGE

The SMS (Stores Management System) page provides information about your F-16’s weapons and equipment. It is also used to allow you to select certain weapons options. With the SMS, you can take inventory of the stores available to you, select among the various weapons on your aircraft, select submodes for weapons and jettison stores. From the Main Menu page, press OSB-4 to access the SMS page.



SMS

The integration of the SMS and FCR systems in the MFDs lets you control all weapons and stores by yourself (that is, you don’t need a weapons systems operator unlike other combat aircraft). On the other hand, it means you must understand how these systems work together. Fortunately, in *Falcon 4.0*, all your stores data are preloaded into the system when you board your aircraft, so you are spared the tedious job of inputting the stores configuration to the Stores computer.



The main stores page gives you OSB access to your air-to-air and air-to-ground weapons, as well as your gun.

- OSB-6** **AAM.** Air-to-air missile page.
- OSB-7** **AGM.** Air-to-ground missile page.
- OSB-8** **A-G.** Bomb page.
- OSB-9** **GUN.** Gun page.
- OSB-13** **FCR.** Switches to the FCR page.
- OSB-14** **SMS.** Returns to the Main Menu page.
- OSB-15** **SWAP.** Swaps the left and right MFDs.
- OSB-20** **INV.** Inventory page.

AAM (Air-to-Air Missile) Page

The AAM page lets you control selection and options for your air-to-air missiles. Depending on your loadout, you can choose AIM-120, AIM-9 or AIM-7 missiles. The display gives you a count of how many missiles you have left and which hardpoints they reside on. You can select which missile (that is, from which hardpoint) you want to fire next. Cycle through the available air-to-air weapon hardpoints by pressing **Enter**. For more information on how to use air-to-air missiles, see **Chapter 4: Air-to-Air Weapons**.



- OSB-1** **AAM.** Air-to-air missile page. Clicking this OSB produces no action.
- OSB-6** **Status, #, weapon type.** This label lists the weapon status (RDY means ready, MAL indicates a malfunction), the number of available weapons and the type of weapon selected. For example, if OSB-6 says "2A120," it indicates that 2 AIM-120 missiles are available and selected. Press OSB-6 to cycle through all the available A-A missile types. Each time a new weapon is selected, a corresponding HUD mode will be displayed in the HUD. The available weapons on the AAM page are A120 (AMRAAM AIM-120), A-9LM (AIM-9 heat-seekers) and A-7 (AIM-7 Sparrow).

- OSB-10** #. This number shows the hardpoint that the selected missile is attached to. If the hardpoint holds the next missile to be launched, the number is shown in inverse video. If you press this OSB, the selected missile moves to the next available hardpoint.
- OSB-11** **S-J**. Switches to the Selective Jettison page.
- OSB-13** **FCR**. Fire Control Radar page. The "RDY" label indicates the general AAM system status.
- OSB-14** **WPN**. This label is highlighted to indicate that you are looking at a specific weapon in the SMS page. Click this OSB to return to the SMS page.
- OSB-15** **SWAP**. Swaps the left and right MFD displays.
- OSB-16** #. This number shows the hardpoint that the selected missiles is attached to. If the hardpoint holds the next missile to be launched, the number is shown in inverse video. If you press this OSB, the selected missile moves to the next available hardpoint.

AGM (Air-to-Ground Missile) Page

The AGM pages are used for air-to-ground missiles such as Mavericks, LGBs, HARMs and the reconnaissance pod. The MFD page that is displayed when you select AGM depends on which air-to-ground missile is currently selected. Cycle through the available air-to-ground weapons by pressing **[Backspace]**. For more information on how to use air-to-ground weapons, see **Chapter 5: Air-to-Ground Weapons**.

MAVERICK PAGE

The MFD becomes an electro-optical (EO) display when the Maverick missile is selected. The display provides a TV view from the missile's seeker head.

- OSB-1** **OPER**. Operational.
- OSB-2** **PRE**. Preplanned mode. Not used in *Falcon 4.0*.
- OSB-3** **FOV**. Field of View. Press this OSB to toggle between normal and expanded FOV. When in expanded FOV, the label changes to "EXP" and is shown in inverse video. You can also press **[V]** to toggle between FOV and EXP.





- OSB-5** **HOC.** Hot on Cold. This mode and its inverse, COH, are used to improve imaging. Not used in *Falcon 4.0*.
- OSB-6** **Status, #, weapon type.** Status will be “RDY” for Ready. The number indicates the number of weapons available. The weapon indicates the type of weapon selected. For example, a typical Maverick page would show “RDY 2AGM65B,” indicating that 2 AGM-65B missiles are available and ready. Press this OSB to cycle through the available weapons. For Mavericks, your possibilities are the AGM-65B, AGM-65D and AGM-65G.
- OSB-10** #. This shows the hardpoint that the selected missile is attached to. If the hardpoint holds the next missile to be launched, the number is shown in inverse video. Press this OSB to move the selected missile to the next available hardpoint.
- OSB-11** **DCLT.** Declutter. Not used in *Falcon 4.0*.
- OSB-13** **FCR.** Switches to the FCR page.
- OSB-14** **WPN.** This label is highlighted to indicate you are in the SMS submode. Click this button to return to the SMS main mode.
- OSB-15** **SWAP.** Swaps the left and right MFD displays.
- OSB-16** #. This shows the hardpoint that the selected missile is attached to. If the hardpoint holds the next missile to be launched, the number is shown in inverse video. Press this OSB to move the selected missile to the next available hardpoint.
- OSB-20** **SLAVE/BSGT.** This button cycles through the AGM weapons submodes: “SLAVE” (Slave mode) and “BSGT” (Boresight mode).

Mavericks at Easy Avionics Setting

If you selected Easy Avionics in the Simulation setup, the Maverick missile only works in Slave mode (vs. Boresight). In other words, the Maverick is slaved (tied) to the air-to-ground radar. When you lock onto a target with the A-G radar, the Maverick missile automatically locks onto the same target. A target designator box will appear over the target in the HUD. In addition, the cue “SHOOT” will appear in the HUD when the Maverick is locked onto the target and has a good chance of hitting the target. See **Chapter 5: Air-to-Ground Weapons** for more information on the Maverick slave mode.

LGB PAGE

The MFD becomes an electro-optical (EO) display when the LGB (Laser-Guided Bomb) is selected. The display provides a TV image from the weapon's seeker head.



OSB-1

OPER. Operational.

OSB-3

FOV. Field of View. Press this OSB to toggle between normal and expanded FOV. When in expanded FOV, the label changes to "EXP" and is shown in inverse video. You can also press **[V]** to toggle between FOV and EXP.

OSB-6

Status, #, weapon type. Status will be "RDY" for Ready. The number indicates the number of weapons available. The weapon indicates the type of weapon selected. For example, a typical LGB page would show "RDY 2LGB24," indicating that 2 GBU-24/Bs are available and ready. Press this OSB to cycle through the available weapons. For LGBs, you can choose from GBU-10A/B, GBU-12B/B and GBU-24/B.

OSB-10

#. This shows the hardpoint that the selected missile is attached to. If the hardpoint holds the next missile to be launched, the number is shown in inverse video. Press this OSB to move the selected missile to the next available hardpoint.

OSB-11

DCLT. Declutter. Not used in *Falcon 4.0*.

OSB-13

FCR. Switches to the FCR page.

OSB-14

WPN. This label is highlighted to indicate you are in the SMS submode. Click this button to return to the SMS main mode.

OSB-15

SWAP. Swaps the left and right MFD displays.

OSB-16

#. This shows the hardpoint that the selected missile is attached to. If the hardpoint holds the next missile to be launched, the number is shown in inverse video. Press this OSB to move the selected missile to the next available hardpoint.

OSB-20

SLAVE/BSGT. This button cycles through the AGM weapons submodes: "SLAVE" (slave mode) and "BSGT" (boresight mode).



LGBs at Easy Avionics Setting

If you selected Easy Avionics in the Simulation setup, the LGB only works in Slave mode and the LGB's targeting pod automatically locks onto whatever target is locked up in the A-G radar. To use LGBs, you must first lock onto the target in the A-G radar. When you lock on, the targeting pod will automatically lock onto the same target. For more information on using LGBs, see **Chapter 5: Air-to-Ground Weapons**.

HARM PAGE

When you select the HTS (HARM Targeting System), the MFD displays radar threats.

- | | |
|---------------|---|
| OSB-1 | HTS. HARM Targeting System. |
| OSB-2 | TBL1. OSB-2 is a static label showing that Threat Table 1 is being used to provide HARM targeting data. |
| OSB-4 | INV. Switches to the Inventory page. |
| OSB-6 | RDY #AG88. "RDY" shows the missile system status, # indicates the number of missiles available and "AG88" indicates that the HARM AGM-88A missile is loaded. |
| OSB-7 | PWR ON. Power is always on to the missiles. |
| OSB-8 | BIT. Built-in test. Not used in <i>Falcon 4.0</i> . |
| OSB-10 | #. This shows the hardpoint that the selected missile is attached to. If the hardpoint holds the next missile to be launched, the number is shown in inverse video. Press this OSB to move the selected missile to the next available hardpoint. |
| OSB-11 | S-J. Switches to the Selective Jettison page. |
| OSB-13 | FCR. Switches to the FCR page. |
| OSB-14 | WPN. This label is highlighted to indicate you are in the SMS submode. Click this button to return to the SMS main mode. |
| OSB-15 | SWAP. Swaps the left and right MFD displays. |



- OSB-16** #. This shows the hardpoint that the selected missile is attached to. If the hardpoint holds the next missile to be launched, the number is shown in inverse video. Press this OSB to move the selected missile to the next available hardpoint.
- OSB-19** **Down arrow.** Press this OSB to decrement the range that the MFD displays. The range shows as a value between the decrement and increment labels. You can also press **(F11)** to decrement the range.
- OSB-20** **Up arrow.** Press this OSB to increment the range that the MFD displays. The range shows as a value between the decrement and increment labels. You can also press **(F12)** to increment the range.

HARMs at Easy Avionics Setting

The HTS scope displays both radars that are turned on (transmitting radar energy) and known radars that are turned off. Press **(End)** to lock onto the closest ground-based radar that is in front of you. If no radars are transmitting, the HARM will lock onto the closest non-transmitting radar in front of you that appears on the scope.

Step to the next closest target by pressing **(Page Down)**. Step to the previous target by pressing **(Delete)**. You can always select the closest target in front of you by pressing **(End)**. In the Easy Avionics Setting, enemy targets in the HTS scope are red, friendly targets are blue and neutral targets are green.

Once you are locked onto the target, release the HARM when you see the blinking aiming reticle in the HUD. For information about using HARMS, see **Chapter 5: Air-to-Ground Weapons**.

TARS

The TARS (Tactical Aircraft Reconnaissance System) is used to take camera footage for intelligence gathering. For more information on how to use the reconnaissance pod, see **Chapter 18: The HUD**.

- OSB-2** **RDY.** The MFD label of OSB-2 is either RDY or RUN. It will say RDY when you are on the ground. It will change to RUN when you are in the air and the index counter starts running.
- OSB-4** **INV.** Switches to the Inventory page.
- OSB-6** **RPOD.** This label shows that the TARS pod is loaded on your F-16.
- OSB-11** **S-J.** Switches to the Selective Jettison page.





- OSB-13** **FCR.** Switches to the FCR page. The “RDY” label indicates the recon pod status.
- OSB-14** **SMS.** This label is highlighted to indicate you are in the SMS submode. Click this button to return to the SMS main mode.
- OSB-15** **SWAP.** Swaps the left and right MFD displays.
- OSB-20** **IDX #.** This index counter runs continuously as soon as your plane is off the ground. When you press the weapon release button (**Spacebar**), it records what is inside the piper on the HUD.

A-G (Air-to-Ground) Bombs Page

These pages allow you to select the various bombs that are loaded on your aircraft. You can also control whether bombs are dropped singly or in pairs and how many bombs ripple off when you release them.

The MFD page that is displayed when you select A-G depends on which air-to-ground bomb is currently selected. Cycle through the available A-G weapon hardpoints by pressing **Backspace**.

FREE-FALL BOMBS AND ROCKETS

- OSB-1** **A-G.** Air-to-ground page.
- OSB-2** **Weapons submode.** Press this button to cycle through the available submodes. For free-fall bombs, the submodes are CCRP (Continuously Computed Release Point), CCIP (Continuously Computed Impact Point) and DTOS (Dive Toss). You can also press **□** to cycle through these submodes. “RCKT” is the label for air-to-ground rockets.
- OSB-4** **INV.** Switches to the Inventory page.
- OSB-5** **CNTL.** This Control page is not used.
- OSB-6** **#, weapon type.** This label lists the available number and type of weapon selected. For example, if OSB-6 says “6MK82,” it indicates that 6 Mk-82 iron bombs are available and currently selected. Press OSB-6 to cycle through all the available A-G bomb types.



- OSB-7** **PROF.** Preplanned profiles. Not used in *Falcon 4.0*.
- OSB-8** **PAIR/SGL.** This OSB toggles between pair and single release of bombs. If it says "SGL," then only one weapon will be released at a time. You can also press **[Alt ;]** to drop bombs singly. If it says "PAIR," then weapons will be released in symmetrical pairs. You can also press **[Alt ']** to drop bombs in pairs. Not used for rockets.
- OSB-9** **# FT.** # represents either 25, 75, 125 or 175 feet, which is the separation distance rippled bombs will have when they hit. Cycle through these options by pressing OSB-9 or press **[Ctrl ;]** and **[Ctrl ']**. Not used for rockets.
- OSB-10** **RP #.** Press this OSB to select the number of bombs you want to drop at one time. If the number is "3," then 3 of the selected bombs will ripple off using the interval distance set by OSB-9. You can also set the ripple number by pressing **[Shift ;]** and **[Shift ']**. Since OSB-8 and OSB-10 work together, if you set OSB-10 to 3 and OSB-8 to pairs, you will drop 3 pairs of bombs for a total of 6 bombs. You cannot ripple rockets.
- OSB-11** **S-J.** Switches to the Selective Jettison page.
- OSB-13** **FCR.** Switches to the FCR page. The "RDY" label above this OSB indicates the general system status.
- OSB-14** **WPN.** This label is highlighted to indicate you are in the SMS submode. Click this button to return to the SMS main mode.
- OSB-15** **SWAP.** Swaps the left and right MFD displays.
- OSB-18** **NSTL.** Nose/Tail fuzing. Not used in *Falcon 4.0*.
- OSB-19** **BA.** Burst Altitude which is the altitude at which CBU's will open and disperse. Click the OSB to set the burst altitude to 300, 500, 700, 900, 1,200, 1,500, 1,800, 2,200, 2,600 or 3,000 feet. The higher the altitude, the wider the dispersal pattern but the less concentrated the fire. Be sure not to set the burst altitude too close to your own F-16's altitude.



A-G Gun

Press **[Backspace]** to access air-to-ground guns (strafing mode).

- | | |
|---------------|---|
| OSB-1 | GUN. Gun page. |
| OSB-2 | STRF. Strafe, or air-to-ground gun mode. |
| OSB-4 | INV. Switches to the Inventory page. |
| OSB-6 | Status, #, weapon type.
RDY means the gun is ready.
shows the number of cannon rounds multiplied by 10. A full load of 510 rounds reads "51."
"GUN" indicates that the gun is selected. |
| OSB-11 | S-J. Switches to a page where you can specify individual stores to jettison. |
| OSB-13 | FCR. Switches to the FCR page. The "RDY" label above this OSB indicates the general system status. |
| OSB-14 | WPN. This label is highlighted to indicate you are in the SMS submode. Click this button to return to the SMS main mode. |
| OSB-15 | SWAP. Swaps the left and right MFD displays. |
| OSB-20 | SCOR OFF. The gun scoring option, used during simulated missions, is always off in <i>Falcon 4.0</i> . |



Air-to-Air Gun Page

The Gun page is displayed whenever you select the Vulcan cannon in air-to-air mode.

- | | |
|--------------|---------------------------|
| OSB-1 | GUN. A-A gun page. |
|--------------|---------------------------|



- OSB-2** **Gun submode.** This label indicates the gun HUD mode aiming device. Press this OSB to cycle through the various A-A gun submodes: EEGS (Enhanced Envelope Gun Sight), LCOS (Lead Computing Optical Sight) and SNAP (Snapshoot sight). You can also cycle through these options by pressing .
- OSB-4** **INV.** Switches to the Inventory page.
- OSB-6** **#GUN.** This shows the number of available gun rounds (multiplied by 10). "RDY" to the left of the label indicates the gun is ready.
- OSB-11** **S-J.** Switches to the Selective Jettison page.
- OSB-13** **FCR.** Switches to the FCR page. The "RDY" label above this OSB indicates the general system status.
- OSB-14** **SMS.** Click this button to return to the SMS main mode.
- OSB-15** **SWAP.** Swaps the left and right MFD displays.
- OSB-20** **SCOR OFF.** The gun scoring option, used during simulated missions, is always off in *Falcon 4.0*.

Inventory Page

The Inventory page shows you at a glance everything that is loaded on to your F-16. The page is laid out in an upside-down "V" shape, with the indented areas representing the hardpoint stations. Station 1 is in the lower left corner, station 5 is at the top center and station 9 is in the lower right corner. Stations that have no stores are displayed as a dashed horizontal line. Each dashed line represents a corresponding weapon or rack that can be loaded on the station.



Stations 2 and 8 only support two weapons or racks. Stations 3 and 7 support up to three weapons or racks. Stations 1 and 9 only support AIM-9 or AIM-120 missiles and are at the same indent level as stations 2 and 8.

The station holding the currently selected weapon will be enclosed by a box on the MFD.

A typical station display will read:

- 1 MAU
- 1 TER
- 3 MK82

SELECTED STATION



This display indicates one Miscellaneous Armament Unit (attachment hardware for weapons), one Triple Ejection Rack (used for holding up to three bombs) and three Mk-82 500 lb. bombs on that rack.

The abbreviations on the Inventory page are:

A-120A	AIM-120
A-7	AIM-7
A-9LM	AIM-9M
A-9NP	AIM-9P
AG65B	AGM-65B
AG65D	AGM-65D
AG65G	AGM-65G
AG88	AGM-88
AL131	ALQ-131
B49	BSU-49
B50	BSU-50
BL107	BLU-107/B
BL109	BLU-109/B
BL27	BLU-27
CB52B	CBU-52B/B
CB58B	CBU-58A/B
CB87	CBU-87
CB89	CBU-89B
GB12	GBU-12B/B
GB24	GBU-24/B
GBU10A	GBU-10A/B
RCKT	LAU-3/A
RPOD	Reconnaissance pod
TK300	300 gallon fuel tank
TK370	370 gallon fuel tank
TK600	600 gallon fuel tank

In the upper left corner of the Inventory page is the number of gun rounds (multiplied by 10) is displayed next to the word "GUN." For example, a full load of 20 mm rounds would read "51GUN." Beneath this display is the type of 20 mm rounds loaded into your cannon, which is PGU28 for your F-16.

- OSB-1** **STBY.** Radar standby
- OSB-11** **S-J.** Switches to the Selective Jettison page.
- OSB-13** **FCR.** Switches to the FCR page. The “RDY” label above this OSB indicates the general system status.
- OSB-14** **INV.** This label is highlighted when you are on the Inventory page. Click this button to return to the SMS main mode.
- OSB-15** **SWAP.** Swaps the left and right MFD displays.

SELECTIVE JETTISON PAGE

Press the OSB labeled “S-J” to bring up the Selective Jettison page. The MFD page looks similar to the Inventory page and displays all of the weapons that can be jettisoned. Press the OSB next to a weapon to select it for jettison. You can select any number of stations. Press the weapon release button (**Spacebar**) to jettison all the selected weapons and deselect those stations. Note that while you are at the Selective Jettison page, you cannot drop bombs or fire missiles because the pickle button is busy. You can, however, fire guns.



HUD PAGE

The HUD page puts a representation of the Head-Up Display on the MFD. See **Chapter 18: The HUD** for more information.



RWR PAGE

The RWR page puts the Radar Warning Receiver display on the MFD. This is very useful when you are in the HUD Only view where you can't see the cockpit instruments. See **Chapter 17: The Consoles** for more information about the RWR.

CHAPTER

20



**THE ICP
AND DED**

The ICP (Integrated Control Panel) is an upfront console that gives you control over frequently used communications and navigation functions. The ICP is used in conjunction with a 3-line data display device called the DED (Data Entry Display).

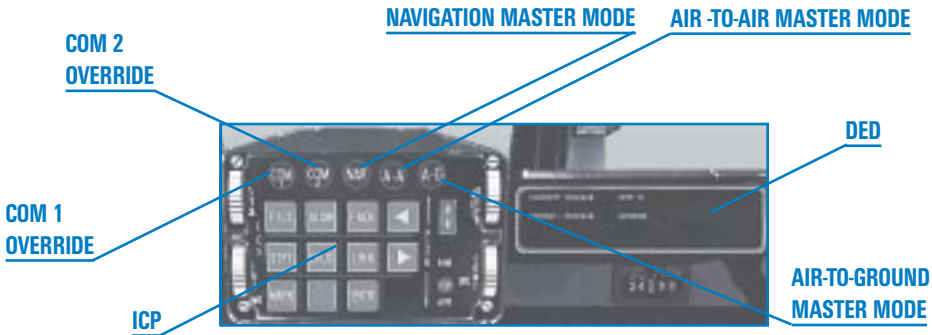

DED

The DED is the display panel to the right of the ICP. To display DED info in the HUD Only view, flip the DED Data switch in the lower left console in the 2-D cockpit.

The DED is only used in *Falcon 4.0* for the *display* of data, not for entering it (with the exception of the MARK function). The default page for the DED typically looks like this:

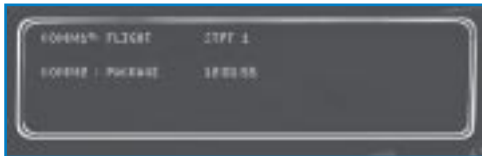

The left column shows the status of the communications channels. The right column displays the current steerpoint with the current time underneath. If you are in Campaign or Tactical Engagement, the TACAN channel is preprogrammed into your flight computer per the mission briefing.

ICP

The ICP provides buttons to access a number of important functions: Master Mode, Override and Priority. The ICP also has increment and decrement buttons.

INCREMENT AND DECREMENT BUTTONS

The increment and decrement buttons are the two arrows used to cycle through pages or values on the DED. You can also press **Ctrl**+ and **Ctrl**- on the numeric keypad.

MASTER MODE BUTTONS

The Master Mode buttons on the ICP are NAV, A-A and A-G. Pressing these buttons places the FCC (Fire Control Computer) into navigational, air-to-air or air-to-ground master modes, which



immediately configure the FCC to the corresponding navigation or attack mode profiles and displays. Pressing a Master Mode button does not change the DED.

NAV (Navigation)

When you press the NAV button, the FCC automatically sets the left MFD (Multifunction Display) to the RWS (Range While Search) radar display (or the last previous radar mode) and the right MFD to the HSD (Horizontal Situation Display).

A-A (Air-to-Air)

When you press the A-A button, the HUD changes to the Dogfight HUD mode, the left MFD displays the RWS (Range While Search) radar mode, and the right MFD displays the guns stores page.

A-G (Air-to-Ground)

When you press the A-G button, the HUD changes to the CCIP (Continually Computed Impact Point) HUD mode, the left MFD displays the GMT (Ground Moving Target) radar, and the right MFD displays the A-G CCIP weapon page for bombing.

OVERRIDE BUTTONS

The COM buttons are the only Override buttons. When you press either COM button, the current DED display is replaced with communications data.

COM1 and COM2

Pressing either COM button makes that channel the talk radio on which you will both transmit and receive. The active channel is designated by a small square to the right of the COMM label on the DED. The other, nonactive radio channel will only receive radio messages. The maximum range of the radio is 300 nm, although the audio quality degrades over distance. The UHF channel display in the lower left console will also show the active radio (COM1 vs. COM2) followed by the comm channel.

COM CHANNELS

SELECTED STEERPOINT

CURRENT TIME



RADIO
CHANNEL SELECTOR

RADIO
FUNCTION KNOB



The DED displays which communications channels the radios are set to. If the radio function knob in the lower left console is set to Norm, click the ICP increment and decrement arrows to change the channel for your active radio. If the switch is set to Backup, use the radio channel selector.

The eight communication channels are:

- 0 **Off** – Off
- 1 **Flight** – To and from your flight
- 2 **Package** – To your package
- 3 **From Package** – To and from your package
- 4 **Proximity** – To and from your team within 40 nm
- 5 **Guard** – To and from your team
- 6 **Broadcast** – Anything broadcast to the world
- 7 **Tower** – To and from the tower your TACAN is tuned to

Your flight is the group of planes on your immediate mission, usually two or four aircraft. Your flight forms one element of a package, which is the group of all flights on the same mission. In Campaign and Tactical Engagement, Guard broadcasts to all allied combatants (U.S. and South Korean). In Dogfight, Guard broadcasts to your team (Crimson, Shark, Viper or Tiger). Broadcast can be heard by everyone. Note that whichever channel you are tuned to, the AWACS and the tanker will always hear you and you will always hear them. For more information about your radio, see “Radio Channel” in **Chapter 17: The Consoles**.

PRIORITY FUNCTION BUTTONS

The nine square buttons are the Priority Function buttons: T-ILS, ALLOW, F-ACK, STPT, CRUS, LINK, MARK and ENTR. (The blank button has no function.) These buttons are used for navigation, data communications and system status. Pressing a Priority Function button will bring up information on the DED. You can also access these buttons by pressing **[Ctrl]** plus the associated key on the numeric keypad. Note that the buttons are laid out in the same approximate order on the keypad as they are on the ICP.

T-ILS

Press the T-ILS button (or numeric keypad **[Ctrl]** **[7]**) to put the TACAN/ILS (Tactical Air Navigation/ Instrument Landing System) page on the DED.

**SELECTED
TACAN
CHANNEL**

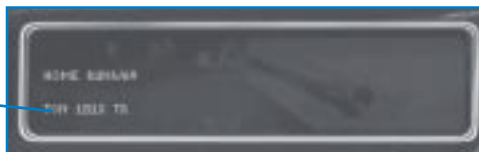



The first line shows the airfield type, which can either be home or an alternate. Home is the landing steerpoint for your current flight plan. The alternates are either alternate landing sites that you've planned or that AWACS recommends. You can have up to five alternate airbases. Cycle through the alternate landing sites with the ICP increment and decrement arrows. The airbase and TACAN information is automatically loaded into your flight computer for each mission. Once you contact the tower the runway designation number tells you the absolute heading of the runway in degrees.

The second line shows the TACAN channel preprogrammed for this mission followed by "TR" for "Transmit/Receive."

ALOW

Press the ALOW button (or numeric keypad **Ctrl** **8**) to set your low altitude warning limit. On the HUD, the ALOW setting looks like a sideways "T" on the altitude tape.

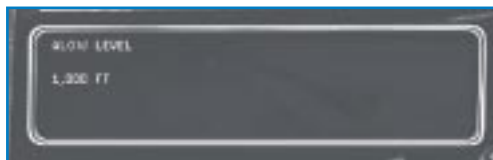

ALOW SETTING

If you fly below this limit, the VMS will sound the warning "ALTITUDE-ALTITUDE" and the "AL" indicator below the altimeter in the HUD will flash. The ALOW default is 300 feet, but you can modify it using the ICP increment and decrement arrows.

F-ACK

Press the F-ACK (or numeric keypad **Ctrl** **9**) to bring up the Fault Acknowledgement page on the DED. This display will inform you of problems with your aircraft. If there are no system faults, you'll see "No Faults."



If there are system faults, you'll see a screen that says "Fault."



"FAULT" on the first line tells you that there is a system fault of some kind. The three items on the next line indicate the subsystem of the fault, the function of the item and the severity of the fault. Press the ICP arrows to cycle through all the faults on the DED.

The subsystems that Fault Acknowledgement can reference are:

AMUX	Avionics Data Bus A
BLKR	Interference Blanker
BMUX	Avionics Data Bus B
CADC	Central Air Data Computer
CMDS	Countermeasures Dispenser Set
DLNK	Datalink
DMUX	Display Multiplexer Data Bus
DTE	Data Transfer Equipment
ENG	Engine
EPOD	Electronic Countermeasures Pod
FCC	Fire Control Computer
FCR	Fire Control Radar
FLCS	Flight Controls
FMS	Fuel Management System
GEAR	Landing Gear
GPS	Global Positioning System
HARM	High-Speed Anti-Radiation Missile
HUD	Head-Up Display
IFF	Identification Friend or Foe
INS	Inertial Navigation System
ISA	Integrated Servo-Actuator
MFDS	Multifunction Display Set
MSL	Missile Slave Loop
RALT	Radar Altimeter
RWR	Radar Warning Receiver
SMS	Stores Management System
TCN	TACAN
UFC	Upfront Controls

The functions that can be referenced are:

A/B	Afterburner
A/I	Anti-ice Valve
A/P	Autopilot
ALL	All Systems
BUS	System Bus
CHAF	Chaff
DMUX	Display Multiplexer



DUAL	Dual System
FIRE	Fire
HYDR	Hydraulics
FLAR	Flare
LFWD	Left Forward Display (MFD)
LDGR	Landing Gear
PFL	Pilot Fault List
RFWD	Right Forward Display (MFD)
RUDR	Rudder
SLV	Slave
SLNT	Silencer
SNGL	Single System
STA1	Hardpoint Station 1
STA2	Hardpoint Station 2
STA3	Hardpoint Station 3
STA4	Hardpoint Station 4
STA5	Hardpoint Station 5
STA6	Hardpoint Station 6
STA7	Hardpoint Station 7
STA8	Hardpoint Station 8
STA9	Hardpoint Station 9
XMTR	Transmitter

The levels of severity can be:

DEGR	Degraded
FAIL	Failed

These subsystems, functions and severity levels are displayed in various combinations to inform you of problems. These fault combinations are shown in the following tables:

Subsystem	Function	Severity	Effect on System	Results
AMUX	BUS	FAIL	No communication on the Avionics A Bus.	No effect unless BMUX also fails; then FCC supports NAV mode only. If both AMUX and BMUX are out, then only NAV mode is available.
BLKR	BUS	FAIL	RWR is less effective and ECM is off.	RWR is nonfunctional.

Subsystem	Function	Severity	Effect on System	Results
BMUX	BUS	FAIL	No communication on the Avionics B.	Bus. No effect unless AMUX also fails; then FCC supports NAV mode only. If both AMUX and BMUX are out, then only NAV mode is available.
CADC	BUS	FAIL	No CADC data available. No effect unless INS/GPS fails; then no airspeed, altitude or orientation data available.	You are flying blind.
CMDS	BUS	FAIL	No chaff and flare dispense.	Countermeasures are unavailable.
CMDS	CHAF	FAIL	No chaff dispense.	Chaff is unavailable.
CMDS	FLAR	FAIL	No flare dispense.	Flares are unavailable.
DMUX	BUS	FAIL	No communication on the DMUX.	HUD and MFDs are nonfunctional.
DTE	BUS	FAIL	DTE inoperative.	Informational only.
ENG	A/I	FAIL	Ice buildup on front frame, or anti-ice valve inoperative.	Informational only.
ENG	A/B	FAIL	No afterburner power.	Afterburners are unavailable.
ENG	FIRE	FAIL	Engire fire.	Aircraft explosion is imminent.
ENG	HYDR	DEGR	Low hydraulic pressure.	Aircraft is unstable over Mach 1.
ENG	PFL	DEGR	Reduced fault detection capability.	Informational only.
EPOD	SLNT	DEGR	Can't turn ECM pod off.	ECM gives away your position while it is emitting.
FCC		FAIL	FCC inoperative.	All weapons are unavailable.
FCR	BUS	FAIL	FCR inoperative. All radar-based weapons are unavailable.	Use boresight when possible.
FCR	SNGL	FAIL	No TWS.	TWS radar mode is unavailable.
FCR	XMTR	FAIL	FCR inoperative. All radar-based weapons are unavailable.	Use boresight when possible.
FLCS	DMUX	FAIL	No HUD display.	HUD is nonfunctional.
FLCS	DUAL	FAIL	FLCS failure and aircraft is unstable at greater than Mach 1.0.	Keep speed below Mach 1.0 or risk losing control of aircraft.



Subsystem	Function	Severity	Effect on System	Results
FLCS	SNGL	FAIL	Non-announced inflight or preflight first failure.	Informational only.
FLCS	A/P	FAIL	Loss of autopilot operation.	Autopilot is nonfunctional.
FMS	BUS	FAIL	No bingo warning.	No warning when fuel is low.
GEAR	LDGR	FAIL	Landing gear is broken.	You cannot land.
HARM	BUS	FAIL	HARM is inoperative.	HARM missiles are nonfunctional.
HUD	BUS	FAIL	HUD inoperative.	HUD is nonfunctional.
IFF	BUS	FAIL	IFF inoperative.	Friendly aircraft are unable to identify you.
ISA	RUD	FAIL	No rudder control.	Rudders are nonfunctional.
ISA	ALL	FAIL	Loss of primary and secondary hydraulic system pressure. Aircraft is unstable at greater than Mach 1.0.	Keep speed below Mach 1.0 or risk losing control of aircraft.
MFDS	LFWD	FAIL	Left MFD inoperative.	Left MFD is nonfunctional.
MFDS	RFWD	FAIL	Right MFD inoperative.	Right MFD is nonfunctional.
MSL	SLV	FAIL	Missile seeker head will not slave to the radar line of sight.	AIM-9s can only be used in boresight mode.
RALT	BUS	FAIL	Loss of digital radar altitude.	Radar altimeter (AGL) is nonfunctional. No ALOW.
RWR	BUS	FAIL	RWR inoperative.	RWR is nonfunctional.
SMS	BUS	FAIL	All functions lost except emergency jettison and selective jettison.	All weapons are unavailable.
SMS	STA1	FAIL	Station operation inhibited.	Weapon(s) on hardpoint 1 unavailable.
SMS	STA2	FAIL	Station operation inhibited.	Weapon(s) on hardpoint 2 unavailable.
SMS	STA3	FAIL	Station operation inhibited.	Weapon(s) on hardpoint 3 unavailable.
SMS	STA4	FAIL	Station operation inhibited.	Weapon(s) on hardpoint 4 unavailable.
SMS	STA5	FAIL	Station operation inhibited.	Weapon(s) on hardpoint 5 unavailable.
SMS	STA6	FAIL	Station operation inhibited.	Weapon(s) on hardpoint 6 unavailable.
SMS	STA7	FAIL	Station operation inhibited.	Weapon(s) on hardpoint 7 unavailable.

Subsystem	Function	Severity	Effect on System	Results
SMS	STA8	FAIL	Station operation inhibited.	Weapon(s) on hardpoint 8 unavailable.
SMS	STA9	FAIL	Station operation inhibited.	Weapon(s) on hardpoint 9 unavailable.
TCN	BUS	FAIL	TACAN is inoperative.	TACAN system is nonfunctional.
UFC	BUS	FAIL	UFC is inoperative.	Upfront Control not working. Switch to backup on TACAN panel.

STPT

Press the STPT button (or numeric keypad **Ctrl** **4**) to select the steerpoints programmed into your flight computer. A typical DED screen looks like:

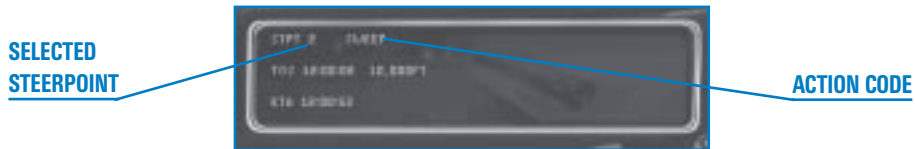

The first line indicates the steerpoint type. The type may be a steerpoint (STPT), an initial point (IP) or a target (TGT). The next item is the planned action code, which can include:

ANTISHIP	Engage enemy ships
ASSEMBLE	Fall into formation
CAP	Combat Air Patrol
CAS	Close Air Support (engage enemy ground units at target)
ESCORT	Engage any enemy fighters along the flight plan
INTRCPT	Engage specific enemy aircraft
IP	Initial Point
LAND	Land
NAV	Navigate to the next steerpoint
RECON	Photograph target location
REFUEL	Midair refueling
S D	Search and Destroy (engage any enemies of opportunity)



SEAD	Suppress Enemy Air Defenses
STRIKE	Destroy enemy installations at target
SWEEP	Engage all enemy aircraft detected
TAKEOFF	Takeoff

If it's a steerpoint (rather than an initial point or target), the second line shows the TOS (Time Over Steerpoint) and your planned altitude. TOS is the clock time that you are expected to be over that steerpoint according to your flight plan.

Unless the action is set to Takeoff, the third line shows ETA and your planned airspeed. ETA (Estimated Time of Arrival) is the computed estimated time of arrival at the steerpoint given your current speed.

CRUS

Press the CRUS button (or numeric keypad **Ctrl** **5**) to bring up the Cruise Management page, which will look something like this:

**OPTIMUM
MACH AND
ALTITUDE**



The first line shows "CRUISE" to indicate the Cruise page. The second item is your destination which can be STPT (steerpoint), MARK (markpoint), DLINK (datalink), HOME (home airbase) or ALTERNATE (alternate landing site). The ICP increment and decrement buttons change the destination number.

The second line shows your optimum Mach at your current altitude and your optimum altitude for the best fuel economy.

The third line shows the fuel remaining over station (FOS) at current altitude and airspeed. Fuel is measured in pounds. The third line also shows the direction the wind is blowing from and its speed. Wind affects the placement of the pitch ladder and the flight path marker on the HUD.

LINK

Your datalink is a secure radio channel that allows the AWACS or FAC (Forward Air Controller) to send you targeting information. In *Falcon 4.0*, data is automatically loaded into your flight computer. On a CAS (Close Air Support) mission, radio to AWACS by pressing **Q** and selecting "Check in." AWACS will respond with target information, which will be displayed as a floating steerpoint (small circle) on your HSD (Horizontal Situation Display).

Press the LINK button (or numeric keypad **Ctrl** **6**) to bring up the info on your DED. Your datalink DED page will usually look like:



MRK and ENTR

Press the MRK button (or numeric keypad **Ctrl** **1**) when you want to mark a certain location as a temporary steerpoint. Mark a temporary steerpoint when you notice a target of opportunity not already assigned to an existing steerpoint. The markpoint is also displayed on your HSD as a small circle.

Click the MRK button and the ICP increment and decrement arrows to select the markpoint number (up to 10). Press the ENTR button (or numeric keypad **Ctrl** **3**) to store your current location as a markpoint. If you press the ENTR button while the GM radar is on, you'll store the GM radar cursor position. Otherwise, you will mark your aircraft's position. Remember, you must click both the MRK and ENTR buttons to store a markpoint.

The Markpoint page will look like this:

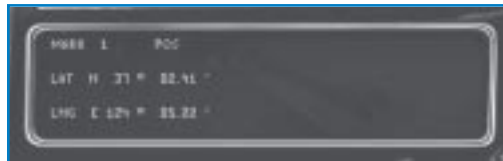

The first line shows "MARK," indicating the MARK page, followed by the markpoint number. The third item is the markpoint type, which is either "GM" for marking the GM mode cursor or "POS" for marking the current aircraft position.

The next two lines show the latitude and longitude of the marked steerpoint.

CHAPTER

21



THE RADAR

Radar (Radio Detection and Ranging) is one of the primary tools you'll use while flying missions in the F-16. In modern battles, much of your airborne situational awareness and intelligence comes from the AWACS (Airborne Warning and Control) radar platform. But your F-16 has its own powerful radar system—and you better know how to use it.

Radar basically sends radio pulses out and listens for any reflection of these pulses back from objects. By processing these return pulses, information can be obtained about the objects. This information is processed by the F-16's programmable signal processor and displayed on the radar scope. Your radar is used for locating threats, gathering information about them and finally for aiming your weapons at these threats. Thus, your radar is intimately tied into your weapons systems and your HUD.

For more information on how to use your radar, see **Chapter 4: Air-to-Air Weapons** and **Chapter 5: Air-to-Ground Weapons**.

RADAR MODES

Falcon 4.0 supports three levels of radar displays: Easy, Simplified and Realistic. Select one of these Avionics modes from the Simulation tab in the Setup window.

The first two (Easy and Simplified) are essentially artificial radar modes. Because mastering the use of radar takes time, we give you a progressive path to understanding how radar is used. The Easy radar gives you instant situational awareness. The Simplified radar starts to operate more like the real thing, but many tasks are automated. The Realistic radar in *Falcon 4.0* is extremely close to the operation and function of the actual AN/APG-68 radar in the F-16C. After you become comfortable with Easy mode, try out the Simplified mode, which is closer to the real radar. Obviously, the Realistic radar mode takes time to learn. Once you master it, however, you'll be able to carry on an intelligent conversation with a real Falcon driver—at least about radar.

EASY MODE

The Easy radar mode is designed to give you an immediate view of all the threats around you in either air-to-air or air-to-ground mode. It shows you the relative position of all vehicles and structures and whether they are hostile, neutral or friendly.

The Easy radar display displays a god's-eye view of the world looking down with your plane at the center. The circles are range rings, and the pie wedge represents the view your radar scans in front of you (the radar cone). In Easy radar, although your radar actually sees everything around you, you can only lock onto targets that are within the radar cone.

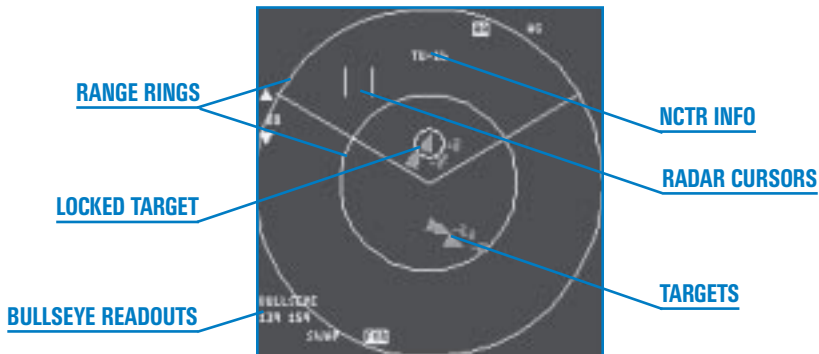

Set the range of the radar scan by pressing **[F3]** or **[F4]**. This determines how far out in front of you the radar will look. You can set the Easy radar display to 40 nm, 20 nm, 10 nm or 5 nm. The outer circle represents the range your radar is set to. The inner circle represents half that range. For example, if the radar range is set to 40 nm, an aircraft on the outer circle would be 40 nm away. An aircraft on the inner circle ring would be 20 nm away.

AIR-TO-AIR MODE

Each aircraft appears as a colored triangle. The colors represent the threat type. Red is hostile, green is neutral and blue is friendly. The number next to each aircraft triangle represents the difference in the plane's altitude, in thousands of feet, from your own. For example, "2" means that the plane is 2,000 feet above you. If it says "-1," the plane is 1,000 feet below you. In addition, the triangle points in the direction the aircraft is heading.

Missiles appear as colored dashes.

Locking Onto a Target

If you want to lock up the target that is on your nose (that is, straight in front of you), press **[End]**.

When you don't have a radar lock, lock up the next enemy target (shown in red) by pressing **[Page Down]**. Locking the next target locks the closest target to you that's within the radar cone. As you continue to press **[Page Down]**, the radar locks onto the next target (further away) and so on.

Lock up the previous enemy target by pressing **[Delete]**. Each time you press **[Delete]**, the radar lock moves from the current target to the next closest target and so on.

You can also manually lock up any target by moving the radar cursors (using **[↑]**, **[↓]**, **[←]** and **[→]**) directly over the target on the radar display. Then designate the target by pressing **[0]** on the numeric keypad. To break the radar lock, press **[.]** on the numeric keypad. Notice that the radar cursors always stay within the radar cone. A locked target will stay locked even if it moves outside the radar cone, but a target must be within the cone in order to *establish* a lock. If you want to lock up neutrals or friendlies, you must manually lock onto them.

Once you lock onto a target, a circle is drawn around the triangle symbol on the radar display.

Starting from the upper right and moving clockwise, the Easy radar display in air-to-air has the following readouts (in clockwise order).

Radar Mode

The current radar mode is highlighted. "AA" stands for air-to-air and "AG" for air-to-ground. Press **[F1]** to select A-A radar mode or press **[F2]** to select A-G radar mode.

Target ID

Below the top readout display, the NCTR (Non-Cooperative Target Recognition) system identifies and displays the type of aircraft that is locked up. NCTR identifies the target by aircraft model, such as Su-27 or MiG-29. It will only work for relatively close aircraft. If NCTR cannot make a useful determination of aircraft type, it will display "???" in the target identification area.

FCR

This label is highlighted, indicating that you are in the Fire Control Radar page. This OSB (Option Select Button) returns you to the Main Menu page. See **Chapter 19: The MFDs** for more details.

SWAP

Press this OSB to swap the displays between the right and left MFDs.

Bullseye

Bullseye is a common reference point used to specify locations. For more information, see the "Bullseye" section under "Realistic Mode" later in this chapter.

Range Scale

Displayed between the up and down arrows, the range scale indicates the range of the outer circle in nautical miles. Click the upper OSB to increase the range or the lower OSB to decrease the range. You can also press **[F3]** or **[F4]** to increment or decrement the range scale.

AIR-TO-GROUND MODE

When you switch to air-to-ground radar mode (**[F2]** key), the display will look slightly different but the operation will be the same as the air-to-air radar modes. In A-G radar mode, targets are displayed as squares. When you lock up a target, a circle is drawn around the square.

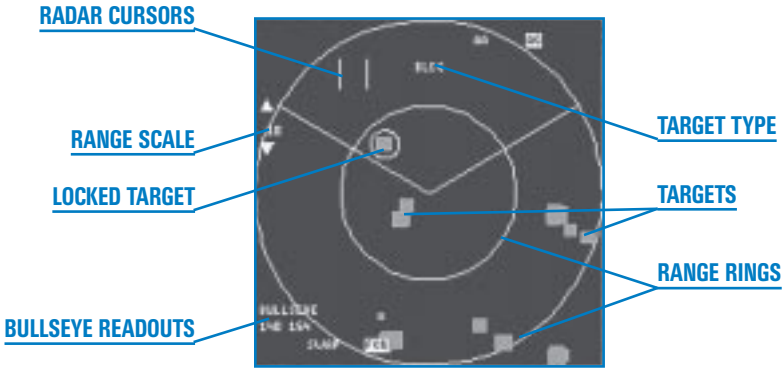

Structures such as buildings and bridges are the medium-sized squares, while vehicle such as tanks and trucks are the small squares. Ground targets are color-coded in the same way as air targets: red for enemy, blue for friendly and green for neutral.

SIMPLIFIED MODE

The Simplified radar is an intermediate mode, somewhere between the Easy mode and the highly accurate Realistic mode. It looks more like the F-16's original APG-66 than the APG-68 radar, and many of the chores are automated for you in this mode. In Simplified mode, the radar acquires targets more quickly than in Realistic mode.

In Simplified mode, rather than displaying a 360° god's-eye view from above, the radar display is a 120° cone, 60° to either side of your aircraft, looking forward. Radar returns appear right or left of the center of the display proportionate to their actual angle to the right or left of the nose of your aircraft (their azimuth). However, their position between the top and bottom of the display indicates their *distance* from you, depending on the radar range scale.

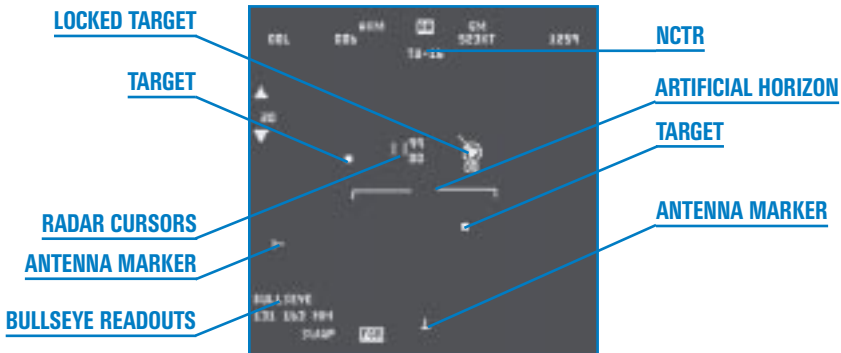

For example, if the radar range scale is set to 40 nm and a radar return is halfway down the screen, the aircraft that is being painted is 20 nm in front of you. If the radar return is halfway to the right, that aircraft is to the right of your nose by 30°.

Simplified radar has two modes: A-A (Air-to-Air) and GM (Ground Map). In addition, A-A mode has a submode: ACM (Air Combat Mode). The highlighted label at the top of the MFD tells you which mode you are in. Select A-A mode by pressing **[F1]**. Select GM mode by pressing **[F2]** (the MFD label will read "GM"). Select the ACM submode by pressing **[D]** to switch to Dogfight mode.

AIR-TO-AIR MODE

Simplified air-to-air mode displays multiple returns. You can lock up a single aircraft while continuing to display the other returns. Unlike Easy radar, a target's threat level is not distinguished by color. All targets look the same.

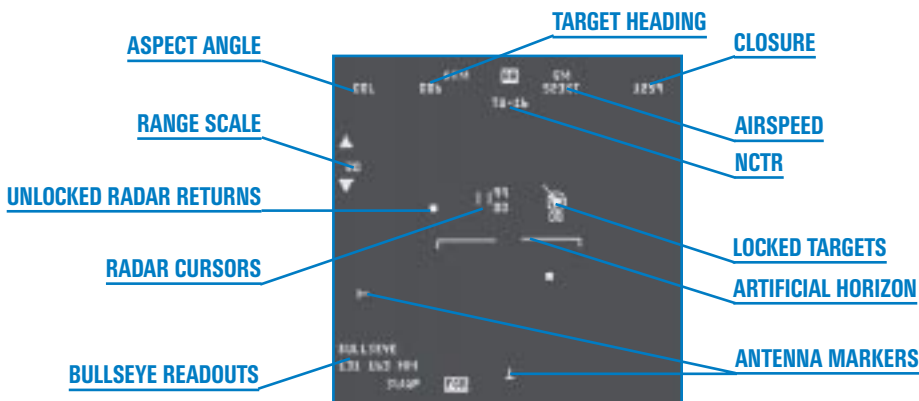

The two numbers next to the radar cursors indicate the upper and lower altitude range the radar can scan (in thousands of feet) at the range of the radar cursors. These numbers will vary according to your altitude and pitch and where the radar cursors are on the MFD. For more information, see "Radar Cursors" below under "Realistic Mode."

Unlocked radar returns appear as small squares. If your radar cannot get a strong return on the target (perhaps because of electronic countermeasures or beaming, which is when the target flies perpendicular to your nose), then the target will be displayed as a dim square. You cannot lock onto a dim target.

Locking Onto a Target

If you want to lock up the target that is on your nose (that is, straight in front of you), press **[End]**.

When you don't have a radar lock, lock up the next enemy target by pressing **[Page Down]**. Locking the next target locks the closest target to you that's within the radar cone. As you continue to press **[Page Down]**, the radar locks onto the next target (further away) and so on.

Lock up the previous target by pressing **Delete**. Each time you press **Delete**, the lock moves from the current target to the next closest target and so on.

You can also manually lock up any target by moving the radar cursors (using **↑**, **↓**, **←** and **→**) directly over the target on the radar display. Then designate the target by pressing **0** on the numeric keypad. To break the radar lock, press **.** on the numeric keypad.

Locked Target

Once you lock onto a target, the target is displayed as a square surrounded by a circle. The attached line represents the velocity vector, indicating the relative direction of travel of the locked aircraft, and its length is proportional to the aircraft's speed. The number under the locked target represents the aircraft's altitude above sea level (in thousands of feet)—not relative to you as in the Easy radar mode.

When a target is locked, the following readouts appear in a second line from the top of the display.

ASPECT ANGLE

Aspect angle is the number of degrees measured from the tail of a target to your aircraft. This readout is in tens of degrees. Aspect angle is important because it indicates where your aircraft is from the target's 6 o'clock position. If your aircraft is in the right hemisphere (as shown in the figure below), you have right aspect; in the left hemisphere, you have left aspect.

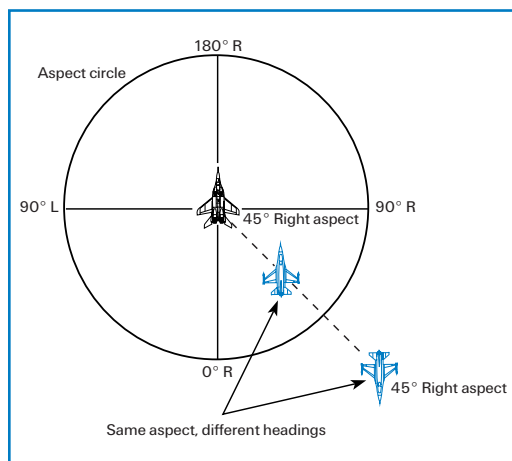

HEADING

This readout shows the direction on the compass that the target is moving. If it reads 120° , the target is on a heading of 120° , regardless of his relationship to you.

SPEED

This readout shows the airspeed in knots of the locked target.

CLOSURE RATE

This readout shows the closure rate between your aircraft and the locked aircraft in knots. Closure is positive if you're gaining on him or negative if he's pulling away.

NCTR

In Simplified radar mode, when you lock onto an aircraft, the F-16 NCTR system determines the type of aircraft you have locked onto and displays this information at the top of the MFD. Aircraft are identified by their aircraft models, such as Su-27 or MiG-29, to help you identify whether the aircraft is friendly or hostile.

NCTR requires a strong return to accurately identify an aircraft and probably won't work on an aircraft that is far away. If NCTR cannot accurately identify an aircraft, it will display "?????" at the top of the MFD.

Artificial Horizon

An artificial horizon appears in the center of the radar screen. This line always stays parallel with the horizon line. The downward tick marks point to the ground. The artificial horizon line will move to the top of the display as you pitch the aircraft down and move toward the bottom of the display as you pull the nose up.

Antenna Markers

You'll see inverted "T" markers along the bottom and the left edges of the radar. These markers indicate the horizontal and vertical position of the radar antenna as it tracks a target. You need to be aware of the maximum limits of these markers because, if the locked target exceeds the gimballed limits of the radar, the radar will drop lock. Don't let the locked target move to either end of the ranges (top or bottom edge for the vertical marker and left or right edge for the horizontal marker). Instead, move the nose of your aircraft so that the target is back in the center of the radar.

FCR

This OSB is highlighted, indicating you are in the Fire Control Radar screen. Click this OSB to return to the Main Menu page. See **Chapter 19: The MFDs** for more details.

SWAP

Press this OSB to swap the displays between the right and left MFDs.

Bullseye

Bullseye is a common reference point used to specify locations. For more information, see the "Bullseye" section under "Realistic Mode" later in this chapter.

Range Scale

Displayed between the up and down arrows, the range scale indicates the range of the outer circle in nautical miles. The range is represented on the radar display as the distance from the top of the display to the bottom. Click OSB-20 to increase the range, or click OSB-19 to decrease the range. You can also press **F4** or **F3** to increment or decrement the range scale. In addition, if you move the radar cursors to the top of the display, the radar will be bumped to the next higher range. Similarly, if you move the radar cursors to the bottom, the radar will be bumped to the next lower range.



GROUND MAP MODE

When you switch to air-to-ground radar mode, the MFD label will read “GM” for Ground Map. This mode is basically the same as with the air-to-air radar modes. Buildings on the ground appear as small squares in GM mode.

If you press **[F2]** or click the OSB next to “GM,” you will switch from GM to GMT (Ground Moving Target). This GMT radar mode shows vehicles (moving or not).

The target you are trying to lock must be within a 60° radar cone and in front of your aircraft. When you lock onto a ground target, a circle is drawn around it. Press **[Page Down]** or **[Delete]** to lock up the next or previous ground target. You can also lock up any target by moving the radar cursors (using **[↑]**, **[↓]**, **[←]** and **[→]**) directly over the target on the radar display. Then designate the target by pressing **[0]** on the numeric keypad. To break the radar lock, press **[.]** on the numeric keypad.

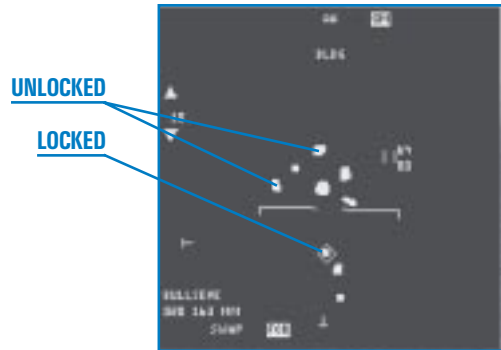

REALISTIC MODE

The Realistic radar is the mode that most closely simulates a declassified version of the AN/APG-68 Block 50 radar in the F-16C. *Falcon 4.0* contains the most accurate rendition of the APG-68 radar you’ll find in any flight simulation for the PC.

Since the air-to-air and the air-to-ground radar modes differ significantly, we’ll divide the discussion about Realistic radar into these two areas.

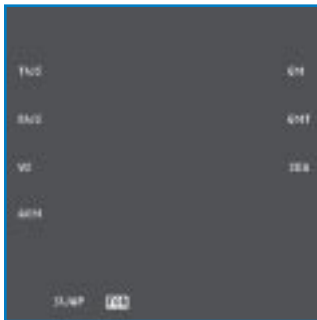

FCR PAGE

The FCR page on the MFD lists the four air-to-air radar modes on the left side of the MFD and the three air-to-ground radar modes on the right side. Select a radar mode by clicking the corresponding OSB. You can also cycle through these radar modes by pressing **[F1]** for air-to-air modes or **[F2]** for air-to-ground modes. You can always return to this page by clicking OSB-14 when the FCR label is highlighted.

REALISTIC RADAR AIR-TO-AIR MODES

The F-16 FCR (Fire Control Radar) system is comprised of an antenna/transmitter and a digital signal processor. The radar information is displayed on the MFDs and the HUD.

Generally speaking, the broadest focus is a search mode in which you are trying to see what is out there in as big a volume of space as possible. As you narrow the focus, you start to get more information about the targets you see but this limits the area you can look at. When you identify a specific threat, you focus on that target exclusively by locking onto it.

Detection is by no means assured with the Realistic radar, just as with the real APG-68 radar. When the radar sweeps the area, if it gets a return, it places this return in a bin according to range. As it sweeps through the area again, the radar checks for a return again at or near that range. It keeps adding hits to the range bin. When the radar has enough hits to feel confident that the return is genuine, it displays the return on the MFD. Therefore, in Realistic radar, you may not see aircraft returns until the radar has made several sweeps of the area.

Controlling the Radar

You control the power of the transmitter by setting the radar range and specify where the radar looks by controlling the position of the radar antenna.

The FCR can scan forward $\pm 60^\circ$ left and right as well as $\pm 60^\circ$ up and down, which means that your F-16's radar can scan a block of 120° by 120° . You control where the radar looks by first pointing your aircraft in the general direction of interest. Then you control the specific area by specifying the magnitude of the azimuth and elevation scan. You can also physically point the radar up or down, left or right within its gimbal limits of $\pm 60^\circ$.

While the radar antenna has this physical range of motion, it is important to understand that in the Realistic radar you will not be able to scan this entire volume at once. Think of each of the air-to-air radar modes as providing a certain amount of *focus* to the viewing area. As you get more focus, you can acquire more information—but the area you can look at gets correspondingly smaller.

You control the azimuth by adjusting the scan volume. The azimuth scans, depending on the mode, can be $\pm 60^\circ$ (the whole width of the radar scope), $\pm 30^\circ$, $\pm 20^\circ$ or $\pm 10^\circ$.

Radar elevation scan is controlled by specifying the bar scan. If the radar just moves left to right and back, that is considered one bar. However, the radar can scan a larger area of vertical space if it moves down after a scan. On a 2-bar scan, for example, the radar scans left to right, moves down a few degrees and scans back right to left. Because the radar antenna has pointed lower, the return scan looks at a different area of space than the first scan. The 2-bar and 4-bar scans are designed to overlap so that no one can sneak between the scan areas.

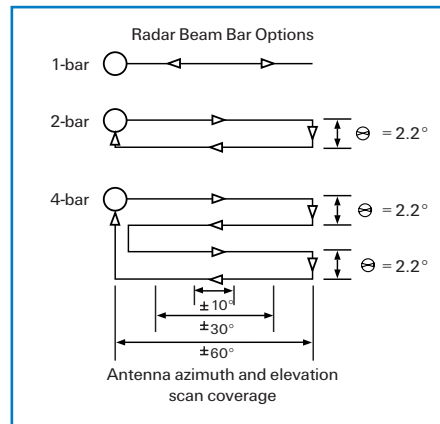

A 4-bar scan covers the most area but takes the longest to complete, over 8 seconds. A 1-bar scan covers the least area but is the fastest, under 2 seconds. The 2-bar scan falls in between. You trade off coverage for quickness of response.

B-Scope

The radar display, which is called the B-scope, is a synthetic display produced by the radar signal processor. It takes the radar cone and stretches the bottom of the cone along the bottom of the display. The entire bottom of the scope represents your F-16's position, not just the center. The target symbol as displayed on the radar represents your line of sight to the target.

In the top example to the right, when you look at Target A (which is further away), you see more of the target's front quarter (which is why the aspect angle is closer to 0°). Even though Target C is pointed in the same direction as Target A, its orientation on the radar display (and its aspect angle) are closer to the 9 o'clock position because it is closer and, therefore, you see more of its left side.

General Air-to-Air Radar Characteristics

Since almost all the air-to-air radar modes share many radar display characteristics, we'll describe these first. Then, we'll discuss specific radar modes and their features.

ARTIFICIAL HORIZON

The radar display has an artificial horizon marker in the center of the display. This line is always parallel with the horizon, and the tick marks point toward the ground. The artificial horizon marker also indicates the pitch of the aircraft.

RADAR RETURNS

Basic radar returns are displayed as small squares. Their position on the display indicates their left/right orientation from your nose, as well as their distance from you (except in VS mode). The square will appear to move as the aircraft moves relative to your own position. In RWS mode, the radar keeps a history of its display of a radar return. When the radar paints a return, it also displays the last three returns for the same object. As the returns "age," they start to dim. So the oldest return will be the dimmest and the most current return will be the brightest. This history display leaves a "track" of the aircraft movement in space.

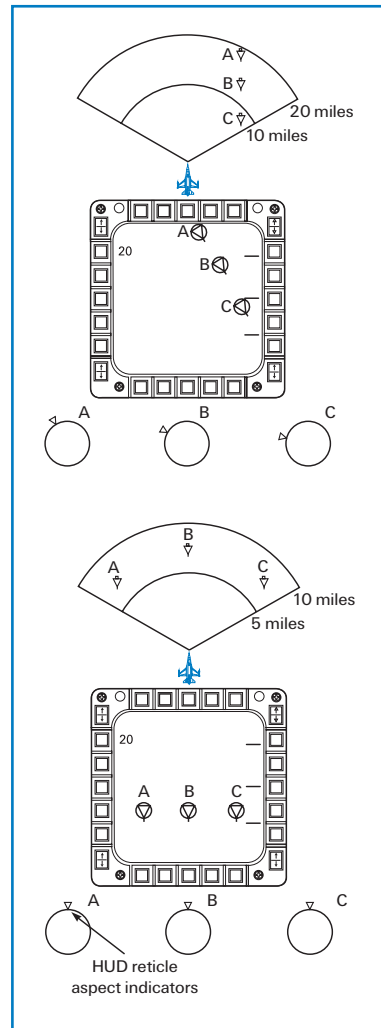

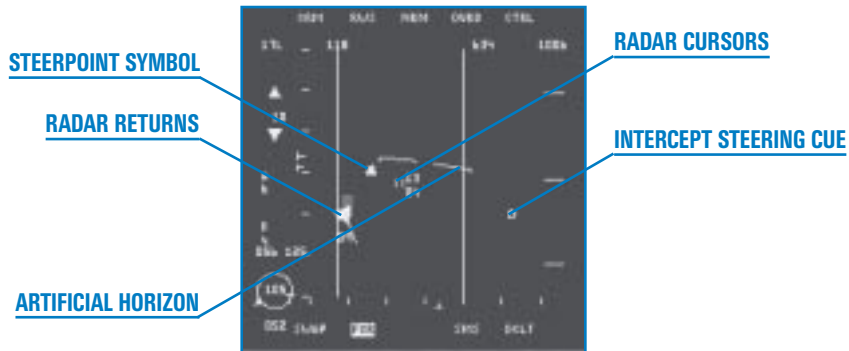

RADAR CURSORS

The cursors consist of two vertical bars with upper and lower elevation data next to them. These cursors (also known as acquisition cursors) are usually used to designate a target. They also indicate the elevation that the radar is seeing *at the range of the cursors*.

For example, if the cursors are in the middle of the display when the radar is set to 20 nm and the cursor elevation values read “34” over “07,” this indicates that *at 10 miles* the radar is scanning the altitudes of 7,000 feet to 34,000 feet. If you moved the cursors up to the top quarter of the scope and the elevation values became “42” over “00,” it would mean that *at 15 miles* the radar is scanning from 0 feet to 42,000 feet. In other words, the radar beam covers a broader area the further away it is (since it spreads out). The cursors simply indicate what the upper and lower altitudes the beam covers at a given range. The range for the displayed elevation is determined by how far from the bottom edge of the scope the cursors are, along with the current radar range setting and the bar scan setting.

It is important to understand that moving the radar cursors up and down does *not* change the elevation of the radar antenna.

Move the radar cursors by using \uparrow , \downarrow , \leftarrow , \rightarrow . In RWS or TWS modes, if you move the cursors to the top of the display, the radar will jump to the next higher range. For example, if the radar was in 20 nm range and you move the cursors to the top of the display, the radar will jump to the 40 nm range and the cursors will be repositioned back at the center of the display. The radar correspondingly jumps to a shorter range if the cursors move to the bottom of the display.

STEERPOINT SYMBOL

This pyramid-shaped symbol is placed at the computed ground range and relative bearing from the F-16 to the selected steerpoint. To head directly for this steerpoint, steer the F-16 so that the steerpoint symbol is in the center of the MFD. You can read its distance against the range scale.



REACQUISITION ELEVATION SYMBOL

This symbol (<) appears along the left side of the radar display for 10 seconds after a target track is lost. It is used to indicate the elevation of the radar to track a locked target at the time the track was lost. Use it to reposition the radar elevation (look for the antenna elevation marker) to the same elevation in order to reacquire the target.

INTERCEPT STEERING CUE

You will see an intercept steering cue if the target is “bugged.” (For information on bugging targets, see “RWS (Range While Search)” and “TWS (Track While Scan)” below.) This cue provides an azimuth direction to intercept the current bugged target. To fly a collision course, fly the F-16 so that the intercept steering cue remains at the (imaginary) centerline of the MFD. To fly a lag pursuit course, put the centerline of the MFD between the steering cue and the target. To fly a lead course, keep the steering cue between the centerline and the target.

NCTR (NON-COOPERATIVE TARGET RECOGNITION)

This system is used to classify radar returns as either friendly or enemy. After analyzing a variety of performance and radar return data, NCTR makes a decision by comparing this data against a library of stored data. The NCTR system makes its best guess as to whether the target is friendly or enemy.

NCTR is only reliable for locked targets (thereby only in STT mode).

The NCTR display appears as a bar. The bar starts at the center and moves either to the left or the right. If the NCTR system determines that the locked aircraft is an enemy, the bar moves toward the left. If it moves toward the right, it has determined the aircraft is friendly. NCTR makes its best guess based on the data it receives. The more certain it is, the longer the bar graph.

OSB Labels

Around the edge of the radar display are a series of Option Select Button labels. They indicate either an existing mode or a function for the corresponding button.



CRM

This label denotes the Combined Radar Mode, as described later.

RADAR MODE

This label shows the current air-to-air radar mode which can be one of four modes:

- RWS** Range While Search
- TWS** Track While Scan
- VS** Velocity Search
- ACM** Air Combat Mode

Press **F1** to cycle through these radar modes.

Each ACM submode has a different function. For ACM mode, "ACM" replaces the "CRM" readout and the submode name (BORE, 20, 60, SLEW) appears to the right of "ACM." Cycle through these submodes by pressing **F8**.

NRM

This label indicates that the radar is operating in its normal mode.

OVRD

Override freezes the radar and stops it from emitting for defensive purposes. This puts the radar in standby mode.

CNTL

This control page for radar operations is currently operational.

DCLT (DECLUTTER)

The declutter option is automatic in *Falcon 4.0*.

SMS

Press this OSB to switch to the Stores Management System page.

FCR

The label on this button is highlighted, indicating you are in the Fire Control Radar system. Click this button to switch to the FCR menu page.

SWAP

Press this OSB to swap the left and right MFDs.

BULLSEYE

Bullseye represents an arbitrarily agreed-upon point that is used as a reference to other locations. *Falcon 4.0* has one bullseye point, located at the city of Kaesong, just over the border in North Korea. By having a specific reference point (that the enemy doesn't know about), you can refer to other locations indirectly. If your communications are intercepted, the enemy will still not know what locations you are referring to unless they also know the (secret) location of your bullseye.

**BULLSEYE POSITION
OF RADAR CURSORS**

**RANGE FROM
BULLSEYE TO YOU**

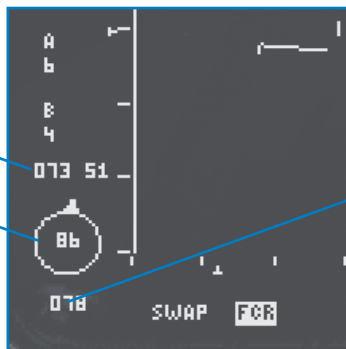

**BEARING FROM
BULLSEYE TO YOU**

Your radar has three indicators for bullseye (which also appears on your HSD). First, a bullseye-shaped graphic appears over the bullseye location on your radar (if you are pointing in the correct direction and close enough). In addition, the radar display has two bullseye readouts. One readout, which looks like a circle, indicates your present location with reference to bullseye. The number inside the circle represents your range to bullseye, and the number below the circle is your bearing from bullseye. The tick mark on the circle represents the line of sight to the bullseye. In other words, it points towards bullseye relative to your nose. The bearing from bullseye is an absolute reference to bullseye regardless of your heading. The second bullseye readout appears under the bar scan/azimuth readout and indicates the bullseye position of your radar cursors. The first number is bearing, and the second number is your range. As you move your cursors, the bullseye value changes, because you are moving the cursors through space.

Use these bullseye readouts in conjunction with AWACS calls. For example, you may hear a call saying, "Bandits bullseye 060 50 miles, angels 12." This means that enemy planes are 50 nm away from bullseye at a bearing of 60° (the bearing is from bullseye, not from you). "Angels 12" means they are at 12,000 feet. If your location shows you are at bullseye 65° at 40 nm, you know you are in the same area as the bandits. If your location is bullseye 30° at 120 nm, you know they are nowhere near you.

In addition, by moving your radar cursors to the bullseye call, you get a quick idea of where the bandits are in relationship to your nose (since your radar is scanning out in front of your aircraft). Of course, the bullseye call can easily be behind you or off to your side, in which case you won't be able to slew your cursors to a position to match the bullseye call without turning.

Bullseye is an option in the Simulation setup screen. If you deselect "Radio Calls Use Bullseye," all AWACS calls will refer to you, rather than a bullseye location. For example, if AWACS calls "Bandits at 350° for 40," this means that if you turn to a heading of 350°, the bandits will be 40 miles in front of you.

AZIMUTH SCAN

The azimuth scan is measured in degrees off the nose of your aircraft. The azimuth selection is displayed with an "A" and a number under it to indicate the width of the radar scan. These numbers can be 6, 3, 2 or 1 for $\pm 60^\circ$, $\pm 30^\circ$, $\pm 20^\circ$ (25° in TWS mode) or $\pm 10^\circ$, respectively. Cycle through these azimuth settings by clicking the OSB next to the "A" symbol or by pressing **F8**.

When the radar azimuth setting is less than 60° , the azimuth scan limits are marked by two vertical lines (the azimuth gates) on the radar display.

The wider scan covers a larger area of space, but it takes correspondingly longer to update the radar screen. A narrower azimuth scan covers a smaller area of space but updates the radar display more quickly. Choose the scan that meets your needs for coverage and response time.

The radar azimuth marker (an inverted "T" symbol) moves across the bottom of the radar display. This indicates the azimuth position of the radar in real time.

BAR SCAN

This option (controllable in RWS and TWS radar modes) controls the number of elevation bars that the radar scans. The number above the "B" label is the bar scan setting which can be 1, 2, 3 or 4 bars. Cycle through these settings by clicking the OSB next to the "B" label or by pressing **Shift F8**.

The radar antenna elevation marker ("T" symbol) moves up and down the left side of the radar display. This symbol indicates the antenna elevation which changes depending on how many bars are being scanned.

Bar scans vary elevation around the center of the scan. You can, however, independently raise or lower where that center is (that is, where the radar is pointing). Tilt the radar down by pressing **F5** or up by pressing **F7**. To center the radar, press **F6**. The "T" marker on the left edge of the radar screen moves as you point the radar.

SUMMARY OF AZIMUTH AND BAR SCANS FOR AIR-TO-AIR RADAR

Azimuth	Bar Scan	
RWS	$\pm 10^\circ$ sweep, $\pm 30^\circ$ sweep or $\pm 60^\circ$ sweep	1, 2 or 4 bars
TWS	$\pm 10^\circ$ sweep	4 bars
	$\pm 25^\circ$ sweep	3 bars
VS	$\pm 10^\circ$ sweep, $\pm 30^\circ$ sweep or $\pm 60^\circ$ sweep	1, 2 or 4 bars
ACM	Azimuth x Elevation	Bar Scan
	30X20 (HUD)	1 bar
	10X60 (vertical)	1 bar
	10X30 (slewable)	1 bar
	Boresight	1 bar



RANGE

You can set the range of the radar presentation in RWS and TWS modes. The range readout consists of a number between up and down arrows. The number indicates the radar display range in nautical miles: 10, 20, 40, 80 or 160. The arrows correspond to the OSB next to them. Press the up arrow to increase the radar display range or the down arrow to decrease the range. You can also change the range by pressing **[F3]** or **[F4]**. A third way to change the range displayed by moving the radar cursors to the top or the bottom of the radar display (as described earlier under “Radar Cursors”).

The range of a target is represented by the distance of that target return from the bottom of the radar display, relative to the set range. If the radar display is set to 40 nm, a return halfway up would be 20 nm from your aircraft.

The right side of the RWS mode display has three tick marks that you can use to gauge the relative position of the target. These tick marks represent the $\frac{1}{4}$, $\frac{1}{2}$ and $\frac{3}{4}$ of the range set. (They are also used in conjunction with the radar artificial horizon marker to show aircraft pitch.)

While VS mode does not display range, it does show information for targets detected within 80 nm. VS mode uses a fixed range of 80 nm, and ACM uses a fixed range of 10 nm.

Combined Radar Mode (CRM) Air-to-Air

The AN/APG-68 radar uses a combined radar mode (CRM) to group the air-to-air radar modes into two modes of operation: search (RWS and VS modes) and multiple target track (TWS mode). In addition, you also have the ACM combat mode.

RWS (RANGE WHILE SEARCH)

RWS is your basic search mode and the one you will probably use the most when you are checking out the airspace. It allows you to track multiple targets and shows you the range of targets as well as their azimuth orientation with virtually no chance of giving away your position. Better at initial detection, RWS also has more accurate information than TWS mode.

TWS (TRACK WHILE SCAN)

TWS gathers information on more than one contact at a time and can “bug” different targets to increase your situational awareness. The radar interpolates the position of targets between scans. In TWS mode, you can determine distance, azimuth and aspect for all targets plus altitude and velocity for the bugged target.

VS (VELOCITY SEARCH)

VS mode is used to determine which of the contacts on your radar screen are moving fast relative to you. It shows you the relative velocities of all the aircraft it is tracking. In practice, VS mode is seldom used because it provides no range information.

ACM (AIR COMBAT MODE)

ACM is the mode to use when in a knife fight. This mode automatically locks up the closest aircraft in the airspace you are scanning, depending on the ACM submode.

STT (SINGLE TARGET TRACK) AND SAM (SITUATIONAL AWARENESS MODE) SUBMODES

Realistic radar has two additional submodes: STT and SAM. STT provides the most accurate information on a target and can better track and hold lock on a target. STT, however, can give away your general position to a bandit. You can enter STT from any of the above radar modes and SAM from RWS mode.

Special Radar Modes

Normally, you will cycle through the radar modes based on the kind of mission you have and the conditions you are flying in. However, you have two override modes that you can jump into immediately if you suddenly find yourself in a dangerous situation. (Note that the Fire Control Radar will turn the radar on if it is in standby, but you will have to manually bring the radar display up on the MFD if it is not already showing.)

These special modes are not just straight radar modes but combination radar and weapons select modes. They are preconfigured, so to speak, to handle specific threat cases.

DOGFIGHT MODE

Dogfight mode puts the radar into ACM mode and also brings up a combined M61A1 cannon and AIM-9 HUD mode. In other words, the HUD will display both the AIM-9 missile reticle and the M61A1 EEGS funnel at the same time. Dogfight mode is designed for short-range threats. Press **[D]** to enter Dogfight mode.

MISSILE OVERRIDE MODE

Missile Override mode puts the radar into RWS mode and selects your AIM-120 AMRAAM or AIM-7 missile. This combination is designed for a medium-range threat encounter. Press **[M]** to enter Missile Override mode.

Cancel either override mode by pressing **[C]** to return to your previous radar and HUD modes.

RWS (Range While Search)

RWS is a basic radar search mode that shows you multiple targets within the radar scan volume. RWS gives you a lot of control over the size and direction of this scan, as we'll describe later. With just a glance, you can tell the distances of all the target returns as well as whether they are to the right or left of your nose.

Any targets that appear in the radar cone are displayed as small squares. Determine a target's ranges and azimuth by its position on the display.

To get detailed information about a specific target, move the acquisition cursors over the target. A number will appear at the bottom of the cursors that indicates the target's altitude in thousands of feet. This number, the Search Altitude Display (SAD), is displayed while the cursors remain over the target. If the target or cursors move, the altitude display disappears.

SEARCH ALTITUDE DISPLAY

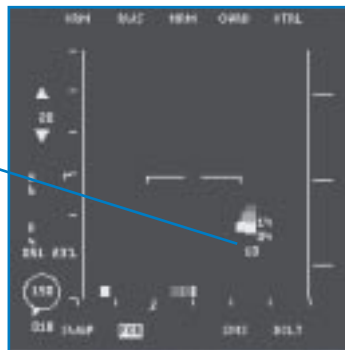

The range of a target return on the radar is determined by its distance from the bottom of the MFD display and the current range selected. For example, if the radar range is 40 nm, a target halfway down the display would be 20 nm from you. If the RWS mode paints four or five bogeys on your radar screen, you can tell which targets are closest to you by looking for the ones nearest the bottom of the screen. Then you can tell about how far they actually are from you by looking at the radar range scale and determining how far up the screen they are.

The target's position to the left or right of the center of the display represents its relative position to the left or right of your nose.

If you hold down the designate target button (0) on the numeric keypad, the radar switches to Spotlight scan mode. In this mode, the radar scans a narrow $\pm 10^\circ$ beam as long as you press the designate target button.

If you put the cursors over the target and designate it (0) on the numeric keypad, you "bug" the target which places the radar into RWS-Situational Awareness Mode (SAM), described below.

RWS-SAM (Situational Awareness Mode)

RWS-SAM is a submode of RWS that lets you track an individual target while continuing to monitor other targets within the radar cone.

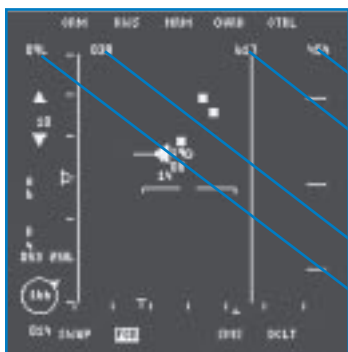

CLOSURE RATE

TARGET AIRSPEED

TARGET HEADING

ASPECT ANGLE

You enter SAM by putting the acquisition cursors on a target while in RWS mode and designating it. The designated target becomes the "bugged" target, and its symbol changes from a square to a triangle with a velocity line. Other radar returns continue to be displayed as small squares. "Bugging" a target tells the radar to pay more attention to that target but also to continue looking at other radar returns.

When you switch to RWS-SAM mode, the scan volume will dynamically change to balance the volume you asked the radar to scan vs. keeping the target bugged. If the radar starts to lose the bugged target, it automatically switches to STT mode to keep track of the target.

The DLZ (Dynamic Lanuch Zone) ranging scale will appear when you have selected A-A missiles and have locked up a target. See **Chapter 18: The HUD** for more information about the DLZ.

Once a target is designated, additional information about that target is displayed in the second line at the top of the radar display as described below.

ASPECT ANGLE

This display gives the target's aspect angle in degrees. Aspect angle is the number of degrees measured from the tail of a target to your aircraft, which indicates how far away your aircraft is from the target's 6 o'clock position.

TARGET HEADING

This number represents the heading of the target in degrees.

TARGET AIRSPEED

This indicator shows the target's airspeed in knots.

TARGET CLOSURE RATE

This display shows the target's closure rate in knots.

TWS (Track While Scan)

Although TWS radar mode gives you more information on multiple targets than RWS, TWS mode is more likely to drop targets than SAM or STT. Interpolating speed, heading, position and aspect, the TWS mode approximates this data since the last time a target was pinged, resulting in some inaccuracy.

Since TWS keeps the radar antenna in a continuous scan, it never stops on an individual target—even a "bugged" target. This reduces the chance that the target's threat indicator will light up but increases the chance of losing track of that target.

TWS mode tracks up to 16 targets. Targets that first appear in the TWS display show up as small squares and are called non-prioritized tracked targets. In *Falcon 4.0*, TWS mode automatically prioritizes targets if they stay within the scan beam for more than three seconds. Prioritized tracked targets are displayed as triangles with a velocity vector extending out the front and an altitude readout below the triangle. The direction of the velocity vector shows the general aspect of the target, and the length of the line is proportional to the target's speed.

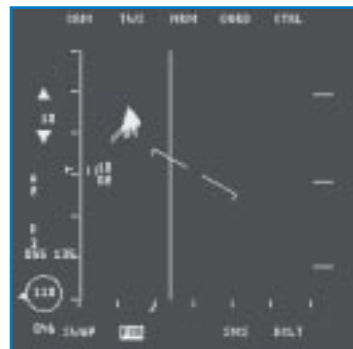



Designate any target as the target of interest (“bugged” target) by putting the radar cursors on it and designating it (0) on the numeric keypad). The bugged target has additional information about it (aspect angle, heading, airspeed and closure) displayed at the top of the radar display.

The DLZ (Dynamic Lanuch Zone) ranging scale will appear when you have selected A-A missiles and have locked up a target. See **Chapter 18: The HUD** for more information about the DLZ.

You can select any other prioritized target as the bugged target by putting the cursors on it and designating it. If you designate an existing bugged target, the radar will go into STT (Single Target Track) mode, described below.

The value of TWS mode is that, at a glance, you can obtain the following information for up to 16 targets:

- ✦ Distance
- ✦ Heading and aspect angle
- ✦ Velocity
- ✦ Altitude
- ✦ Azimuth

The trade-off for getting this amount of information is that TWS forces the radar to scan a relatively small area of space in front of your aircraft. TWS sets the radar into one of two azimuth/elevation search patterns. It defaults to a 3-bar $\pm 25^\circ$ pattern which means that the radar scans 25° on either side of the acquisition cursors and uses a 3-bar pattern for elevation scanning. You can also switch to a 4-bar $\pm 10^\circ$ pattern. The left side of the radar display will say either “A2B3” or “A1B4,” respectively.

VS (Velocity Search)

The purpose of the VS radar mode is to detect aircraft that are coming at you and determine which ones are moving the fastest. Usually, the fast movers are the ones you need to be the most worried about.

Velocity search mode is different from the other radar modes because the distance from the top to the bottom of the radar display is not used to determine distance information of the tracked targets. Instead, it is used to determine velocity information.

VS mode defaults to a radar range of 80 nm. The range indicator, however, is replaced by a velocity scale which reads either 1,200 or 2,400 knots. You determine the velocity of a radar return by its position on the display. If the scale is set to 1,200, a return at the top of the display has a closure rate of 1,200 knots. A return at the bottom quarter of the display means a closure rate of 300 knots. Thus, returns that are higher up on the display are moving toward you faster than those lower, relative to you.

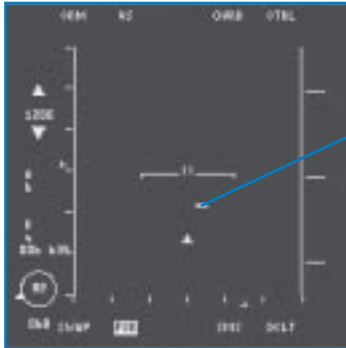

RADAR RETURN

Radar returns in VS mode are displayed as horizontal lines, rather than small squares. You can still determine azimuth information about a return by its left/right orientation on the display.

The VS mode only shows aircraft with a positive closure. This obviously applies to aircraft moving toward you. In addition, if an aircraft is moving away from you at 300 knots and you are heading toward it at 500 knots, you still have a positive closure of 200 knots and it would show up on the VS mode display.

Designate targets in the VS mode in the same way as other modes. When you place the radar cursors over a return and designate it (0 on the numeric keypad), you lock up the target and switch to STT mode. Once you lock a target, however, the display changes to a range-based display where the target distance from the top of the display indicating its range from you, not its velocity. If you lose or break lock, the scale reverts back to a velocity scale.

If you hold down the designate target button (0 on the numeric keypad) without the cursors over a target, the radar switches to Spotlight scan mode. In this mode, the radar scans a narrow $\pm 10^\circ$ beam as long as you press the designate target button.

ACM (Air Combat Mode)

ACM mode is used for close-in dogfighting when things are moving fast and furious. ACM's main feature is that it automatically locks up the first target it sees. Since ACM's fixed, default range is 10 nm, switch to this mode when somebody dangerous is close to you. You will almost always use this mode for visual targets.

ACM has four submodes that modify the azimuth/elevation scan the radar performs. Each submode has its own advantages in certain circumstances. Cycle through the ACM submodes by pressing [F8].

When you first enter the ACM mode, the radar will stop emitting and "NO RAD" will be displayed on the HUD and radar display. Since the radar is off, you can select the ACM submode you want before locking onto a target. The first submode you select will automatically turn on the radar.

30X20 SUBMODE

The 30X20 submode is also called the HUD submode because the 30X20 degree scan pattern is roughly equivalent to the field of view through your HUD. This is the





Targets are automatically locked up just as they are with the 30X20 submode. That is, the first target to appear in the search range is automatically locked up.

You will see a large cross on the HUD under the gun cross along with a slew circle cue. The cue indicates the direction the radar is searching.

The main advantage of slewable submode is that you can slew the radar to a target and lock on without having to point the aircraft directly at the target. Press **Ctrl F7** to switch to the slewable submode.

STT (Single Target Track) Mode

STT mode can be entered from any other radar search mode or submode. It is the finest level of "focus" of the radar and is similar to ACM mode in that you are only focused on one target. STT is the least likely to break lock and is the only means to get NCTR.

A target in STT appears as a triangle with a circle over it. All other tracked targets disappear from the radar display. Other characteristics of the STT radar mode are:

- ✦ The radar range scale switches automatically to keep the target in the center of the radar
- ✦ A steerpoint symbol displayed on the radar

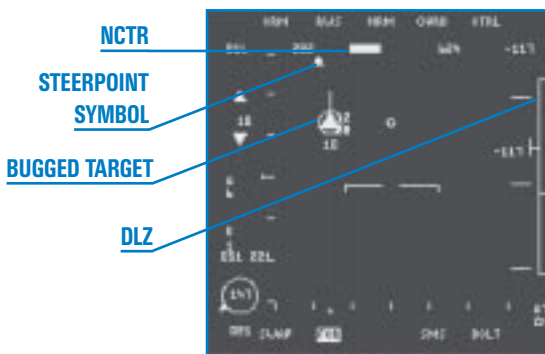

The DLZ (Dynamic Launch Zone) ranging scale will appear when you have selected A-A missiles and have locked up a target. See **Chapter 18: The HUD** for more information about the DLZ.

To switch to STT mode:

- | | |
|------------------------|---|
| In RWS mode | Put cursors over search target and designate the target twice |
| In RWS-SAM mode | Put cursors over the target and designate once |
| In TWS mode | Put cursors over the bugged target and designate once or designate twice if not a bugged target |
| In VS mode | Put cursors over the search target and designate |
| In ACM mode | STT mode is automatic |



RADAR JAMMING

Many aircraft in *Falcon 4.0* have the capability to carry self-protection jammers used to defeat enemy air-to-air and ground-to-air radars.

An aircraft using a self-protection jammer will be displayed as an "X" on the radar scope. This "X" symbol will be positioned on the scope in approximately the correct range and azimuth location. The illustration below shows an aircraft with a self-protection jammer displayed on the radar scope.



The good news for the pilot is that the jammer is positioned at the correct azimuth and range on the scope. The bad news is that you cannot lock the radar onto the target. The "X" symbol will stay on the scope and track until the radar "burns through" the jammer. Burn through is the state where the power in the F-16 radar overcomes the power of the jammer allowing the radar to see or "burn through" to the target. Burn through is a non-trivial calculation that analyzes signal-to-noise ratios based on the range and aspect of the target along with radar cross section and background clutter. It is not

important to know the exact formula for burn through, but it is important to note that you will eventually burn through the jammer and see the target. When you burn through, the "X" symbol will remain on the scope and a small target square will appear in the middle of the "X." You can now lock onto the square and track the target. All of the normal Realistic radar symbology will be displayed, but the "X" will remain as long as the jammer is present.



Self-protection jamming does not make an aircraft invisible. In fact, it highlights the position of the jamming aircraft from ranges further out than normally possible. Self-protection jamming, however, does protect the aircraft from being locked

up on radar and thus being shot at by long-range radar-guided missiles. In other words, a jamming aircraft will take away your long-range AIM-120 shot. Jamming is most effective when the radar you are jamming is below your aircraft.

REALISTIC RADAR AIR-TO-GROUND MODES

Falcon 4.0's Realistic radar supports three air-to-ground radar modes: GM (Ground Map), GMT (Ground Moving Target) and SEA.

GM is used to locate fixed targets on the ground, whereas GMT is used to locate moving targets on the ground. SEA is optimized to locate targets on the ocean. Cycle through the air-to-ground radar modes by pressing **F2**.

General Air-to-Ground Radar Characteristics

Since the A-G (Air-to-Ground) radar modes share many characteristics in common, we'll describe them first. Then we'll discuss specific details.

The A-G radar modes use a pie-wedge display (as opposed to the B-scope display of air-to-air modes) and processes the signal to give you a top-down view. You are located at the bottom center of the pie wedge. Radar returns will never be displayed in the areas outside the pie wedge.

The radar has an artificial horizon marker in the center of the display. This line is always parallel with the horizon, and the horizon tick marks point toward the ground. The artificial horizon marker also indicates the pitch of the aircraft, moving toward the top of the display when your nose is pitched down and moving toward the bottom when pitched up.

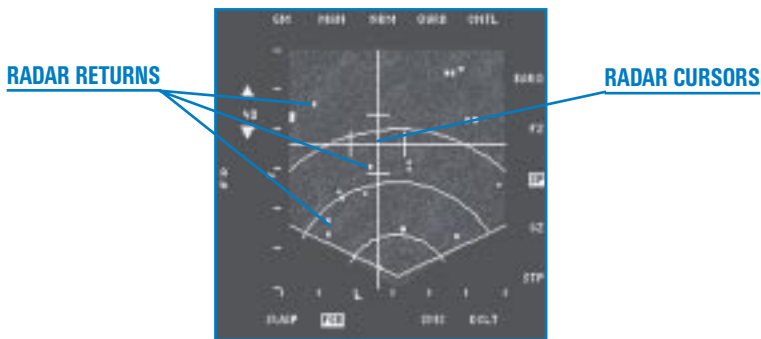

RADAR RETURNS

Basic radar returns are displayed as small squares. Their position on the display indicates their left/right orientation from your nose, as well as their distance from you. The squares will appear to move as your aircraft moves in relationship to the targets.

RADAR CURSORS

The radar cursors in A-G mode consist of cross hairs. The tick marks on these lines form the expansion cue markers. These radar cursors automatically appear over the current steerpoint if you are in Steerpoint mode. If the steerpoint is not within range of the radar or outside of the $\pm 60^\circ$ azimuth scan, the radar cursors are placed against the edges of the MFD.

STEERPOINT MODE

Ground radar modes as a rule focus around a steerpoint. Except in the special Snowplow mode, the radar will try to scan an area of ground around the currently selected steerpoint. This means that, regardless of how far away the steerpoint is, the radar will try to scan an area around the steerpoint. This has important implications.



First, if the steerpoint is beyond the range of the radar (for example, the steerpoint is 60 nm away but a 20 nm scope is displayed), you will get a partially blank scope. The radar cursors will be pegged against the sides of the radar that are closest to the steerpoint. Similarly, if you are within range but are not pointed in the direction of the steerpoint, you'll get a blank scope since the steerpoint is outside the gimbal limits of the radar antenna.

If the range of the radar includes the steerpoint and you are pointed toward it, the radar display will show ground information around the steerpoint, including ground terrain texture if the gain is turned up ((Shift)F3) and ((Shift)F4). If you veer away from your steerpoint, however, you'll see the ground terrain slide around your scope. Once you turn away from the steerpoint far enough, the radar image will be sliced off.

Remember that when you set the radar to a 40 nm range, the display is trying to draw a ground image ± 20 nm around the steerpoint. It will keep this image on the display as far as it can, but as you turn away from the steerpoint, this image will slide off the scope. Therefore, some parts of the image may be displayed and the rest of the scope may be blank.

While the radar cursors are set to the current steerpoint, they can still be slewed with \uparrow , \downarrow , \leftarrow and \rightarrow . The radar will then be looking in the area of the new cursors.

SNOWPLOW MODE

With Snowplow mode, you decouple the radar from the current steerpoint, after which the radar will simply scan ahead of the aircraft with a $\pm 60^\circ$ azimuth scan. Use this if you are looking for ground targets of opportunity not near any programmed steerpoints.

In Snowplow mode, use \uparrow , \downarrow , \leftarrow and \rightarrow to move the radar cursors around. To lock up a target, place the cross hairs over the target and designate it (0) on the numeric keypad). When a target is locked up, a diamond appears around the target return on the radar display.

Once a target is locked, Maverick missiles and LGBs can be automatically slaved to the target.

OSB Labels

Around the edge of the radar display are Option Select Button labels. They indicate either an existing mode or a function for the corresponding button.

The OSB labels below tells you which air-to-ground radar mode you're in.

- GM** Ground Map
- GMT** Ground Moving Target
- SEA** Sea mode

MAN

This is a fixed display which has no function in *Falcon 4.0*.

NRM

This displays the current FOV (Field of View) options.

NRM Normal mode

EXP Expanded mode

DBS1 Doppler Beam Sharpening mode 1

DBS2 Doppler Beam Sharpening mode 2



Only GM mode has all four options. GMT and SEA have only the NRM and EXP options. These options are described in more detail below.

OVRD

Override puts the radar into standby mode and stops it from emitting radar energy for defensive purposes.

CNTL

This control page for radar operations is currently operational.

BARO

This stands for Barometric ranging and is not used in *Falcon 4.0*.

FZ (FREEZE)

In this submode, the current radar screen is frozen and the radar stops radiating. Although the map information is not updated, a "T" symbol representing your current position appears on the display and is updated in real time. You can also select this mode by pressing **F10**.

SP (SNOWPLOW)

Switch to Snowplow mode by pressing this OSB or **Shift** **↑**. This label highlights when Snowplow mode is selected. Snowplow mode and Steerpoint mode (see below) are mutually exclusive.

CZ (CURSOR ZERO)

The Cursor Zero function erases any slew that you may have put into the system by moving the radar cursors around. Select Cursor Zero to return the cursors to the last steerpoint (if you are in Steerpoint mode) or back to the center (if you are in Snowplow mode). Toggle Cursor Zero with **Shift** **↓**.



STP (STEERPOINT)

Press this OSB to center the radar on the current steerpoint. If the steerpoint is outside of 60° azimuth or beyond the range of the radar, the radar cursors are parked at the edge of the MFD. The label highlights when Steerpoint is selected. Steerpoint mode is mutually exclusive with Snowplow mode.

DCLT (DECLUTTER)

The declutter option is automatic in *Falcon 4.0*.

SMS

Press this OSB to switch to the Stores Management System page.

FCR

The label on this button is highlighted, indicating you are in the Fire Control Radar system. Click this button to switch to the FCR main menu page.

SWAP

Press this OSB to swap the left and right MFDs.

AZIMUTH SCAN

The azimuth scan is measured in degrees off the nose of the aircraft. The azimuth selection is displayed with an "A" and a number under it to indicate the width of the radar scan on either side of the nose of the aircraft. In air-to-ground mode, the azimuth scan is always fixed at $\pm 60^\circ$.

The radar azimuth marker (the inverted "T" symbol) moves across the bottom of the radar display. This indicates the azimuth position of the radar antenna in real time. In air-to-ground mode, the radar always scans a fixed bar scan of 1 bar.

RANGE

Displayed between up and down arrows, the range scale indicates the range of the outer circle in nautical miles: 10, 20, 40 or 80. Click the corresponding OSBs to increase or decrease the range. You can also press **F4** or **F3** to change the range. In addition, if you move the radar cursors to the top or bottom of the display, the radar will be bumped to the next higher or lower range.

The range of a target is represented by the distance of that target return from the bottom of the radar display, relative to the set range. For example, a return three-quarters of the way to the top of a 40 nm scope would be 30 nm from you.

The A-G radar ranges of 20, 40 and 80 nm are displayed as three concentric range arcs spaced equidistant from the bottom of the display. The first arc is 25% of the range scale, the second is 50%, the third is 75% and the top of the radar display represents the entire range scale. If the range is set to 10 nm, the one arc halfway up the display represents 5 nm.

Radar Gain Controls

You can decrease or increase the radar gain while in the ground modes. Press **[Shift][F3]** and **[Shift][F4]** respectively. If you increase the radar gain enough, you'll see contour images on the radar display. Decrease the gain if this information clutters the display too much. The new settings do not take effect until the next radar sweep.

EXPANSION CUE MARKERS

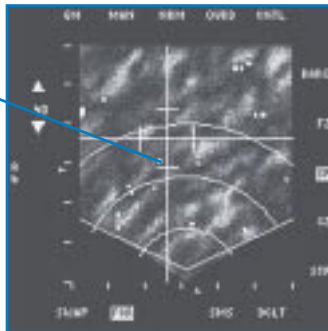

GM (Ground Map) Mode

GM mode is used to find man-made objects on the ground such as buildings, bridges, airbases, etc. The radar is able to break these objects out from the general ground return and can lock on strong target returns. It also shows major terrain features such as roads, rivers, forests, etc.

When you switch to GM mode, the radar will automatically point at the current steerpoint (and the radar cursors will fix at this point) as long as it is within range and within a $\pm 60^\circ$ azimuth to your nose. You can slew the radar cursors around this point using **[↑]**, **[↓]**, **[←]** and **[→]**. If you find a target you want to lock up, slew the radar cursors over it and designate the target (**[0]** on the numeric keypad). A diamond will appear over the target indicating that it is locked into Fixed Target Track.

GM mode has four FOV options that allow you to zoom in and sharpen the radar picture:

- NRM** Normal ground map display
- EXP** Expands the view within the expansion cue markers by 4:1 over NRM
- DBS1** Doppler Beam Sharpening option 1 provides an 8:1 improvement in resolution over NRM but updates more slowly
- DBS2** Doppler Beam Sharpening option 2 expands the view 8:1 over NRM and increases resolution by 64:1 over NRM but updates very slowly

Cycle through these FOV options by pressing **[F9]**.

When you select EXP, the area within the expansion cue markers is expanded to fill the radar display. The next FOV display, DBS1, doesn't expand the view any more (which is why EXP mode has no expansion cue markers), but DBS1 does improve the resolution.

The area in the display for EXP and DBS1 is one-fourth of the range scale. The display area is 2.5 x 2.5 nm, 5 x 5 nm, 10 x 10 nm or 20 x 20 nm square when the range setting is 10 nm, 20 nm, 40 nm or 80 nm, respectively. The 80 nm range scale is not available in DBS1 or DBS2.



When you change the FOV, other things in the display change besides an increase in expansion or resolution. First, the cursor position is fixed in the center of the display. If you try to slew the radar cursors, they stay in the center of the MFD and the ground moves underneath them. In addition, a thin cross appears while in EXP, DBS1 and DBS2 modes to indicate the actual azimuth and range of the radar cursors if it wasn't in an expanded display. For example, if you were in EXP mode, the radar cursors would be locked in the center of the display, but the thin cross might be in the lower right of the screen. This means that if you went back to NRM mode, the radar cursors would be skewed to the lower right of the radar display.

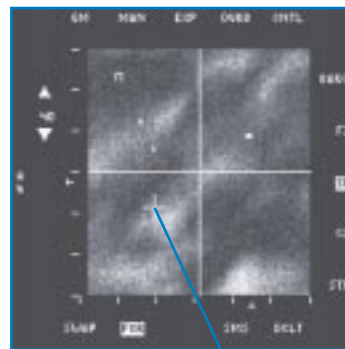

THIN CROSS

QUARTER MILE SCALE REFERENCE

Whenever you are in any of the expanded FOV options (including DBS1 and DBS2), a horizontal line is displayed in the upper left corner. This is a reference line which indicates one-quarter mile (1,500 feet) which lengthens in relationship to the display as you increase the FOV.

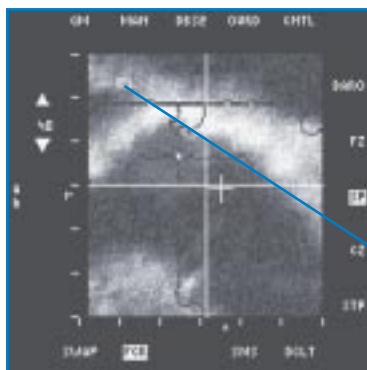

**QUARTER MILE
REFERENCE SCALE**

GMT (Ground Moving Track) Mode

GMT mode tracks moving ground targets rather than stationary ones. It looks for ground targets moving under 100 mph. The air-to-air modes have special filters to filter *out* moving ground targets. GMT mode is where you go to look for these targets. In GMT mode, you'll find objects like tanks and trucks. In GM mode, you might find a bridge but wouldn't be able to see trucks on it. In GMT mode, you can spot the trucks but won't see the bridge.

GMT mode does not provide terrain returns and only works out to 40 nm. DBS modes are not available in GMT.

GMT mode defaults to Snowplow. Lock up targets in GMT mode the same way as you would in GM/Snowplow mode.

SEA Mode

SEA mode is optimized to declutter noise generated by the ocean and is designed to find ships at sea. This mode is functionally the same as GM mode, except that it doesn't support the DBS1 and DBS2 FOV options.

CHAPTER

22



THE VIEWS

“Keep your eye on the ball and fasten your seat belt!” *Falcon 4.0* features many views—from both inside and outside your jet—which you can access from the number keys on the top row of the keyboard (but not the numeric keypad). Understanding the benefits of each of these views will help you in any situation.

INSIDE VIEWS

Falcon 4.0 provides a number of views from inside the cockpit. Use these inside views to look at your cockpit instruments, flip switches, scan your radar and perform other tasks.

HUD ONLY VIEW

Press **1** on the top row of the keyboard for the HUD Only view. Use the HUD Only view when you need an uncluttered view out the front of your F-16.

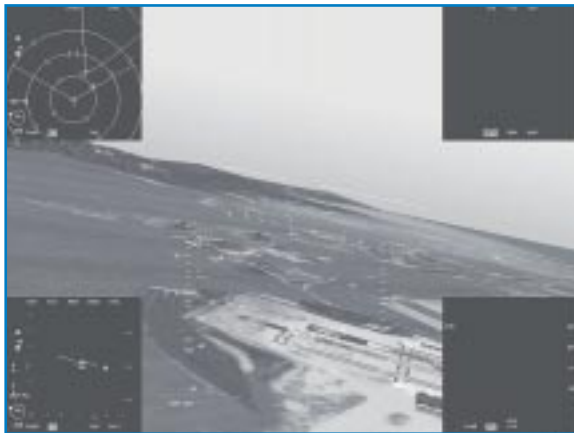





This view can display up to four MFDs (Multifunction Displays), including your RWR (Radar Warning Receiver), your HSD (Horizontal Situation Display) and your radar displays. See **Chapter 19: The MFDs** for more information.

- ✦ Press **1** to display the lower left MFD.
- ✦ Press **2** to display the lower right MFD.
- ✦ Press **Shift 1** to display the upper left MFD.
- ✦ Press **Shift 2** to display the upper right MFD.

2-D COCKPIT VIEW

Press **2** on the top row to switch to the 2-D Cockpit view, “command central” for all your instruments. The 2-D Cockpit is the default view.



Use the hat switch on your joystick or , ,  and  on the numeric keypad to look up, down, left and right around the cockpit. To look around with your mouse, move the pointer to the side of the screen in the direction you want to look. If there is an available view, the mouse pointer will change into a green arrow pointing in that direction. Click your mouse when the arrow is displayed to move your field of view.

When you look up on either side of the aircraft at 30°, 60° or 90° above eye level, a small box appears listing your current pan and tilt in degrees and your airspeed/elevation. This is another visual indicator of your current field of view. If you're in a tense situation and can't figure out which way you're looking, check the pan and tilt indicators if they appear onscreen.

For extra help with orientation, look for red chevrons, which point toward the front of the cockpit. A single chevron indicates that you are looking at the forward quarter of the canopy, a double chevron indicates you are looking out along the side or straight up, and a triple chevron means you are looking at the rear quarter.

Keep in mind that in this view you can only see what a real F-16 pilot can see, and that visibility is limited by the body of the aircraft. You cannot see behind your seat or below the aircraft.

Interacting With the Cockpit

When your mouse cursor is a red diamond, this means that you cannot click on the cockpit instrument underneath the cursor. If you move the cursor over a button that can be pressed or a switch you can flip, the cursor will change into a green circle. If the green circle has arrows, this means that you can turn the dial underneath. Click your left or right mouse button to turn the dial to the left or right. If the cursor looks like a green "U" with arrows at the ends, you can pull or move the lever underneath. For more information, see **Chapter 17: The Consoles**.

VIRTUAL COCKPIT VIEW

Press **[3]** on the top row to switch to the Virtual Cockpit, a 3-D view of your cockpit. In Virtual Cockpit, you can swivel your viewpoint using **[↑]**, **[↓]**, **[←]** or **[→]** on the numeric key pad or the hat switch on your joystick.

In the Virtual Cockpit, you cannot click on cockpit switches or knobs. However, the following instrumentation does work:

- ✦ HUD
- ✦ All MFDs except the displays for Mavericks and LGBs
- ✦ Any dial or gauge with a needle
- ✦ Master Caution Light

While you have limited interaction with the cockpit, the Virtual Cockpit allows you to scan the horizon easily. Your visibility is limited, however, by the airframe: you cannot see behind you or underneath the aircraft.

The Virtual Cockpit includes a realistic whiplash feature that simulates the way your head moves when you scan the horizon. When you swivel your head all the way around, the view from over your left shoulder flips to over your right shoulder (or vice versa) with the press of a button. When you hear a “thump” sound while scanning behind your aircraft, press the arrow key or hat switch again to flip to the other side.

SA (Situational Awareness) Bar

Press **[Shift 3]** to toggle the SA bar on or off. The Situational Awareness bar is a window that includes several key instruments and an overhead representation of the canopy (and your entire field of view), showing you where the current threat is in relation to your aircraft.

The SA bar shows the *lift vector* of your aircraft. The vertical line in the center of the reference bar depicts the center of the canopy from front (the bottom of the box) to back (the top of the box). Use the lift line to “pull” the aircraft along the lift vector line by aligning the plus symbol with the lift vector.

To the left of the lift line represents looking out the left side of your canopy. To the right side represents looking out the right side of the jet.



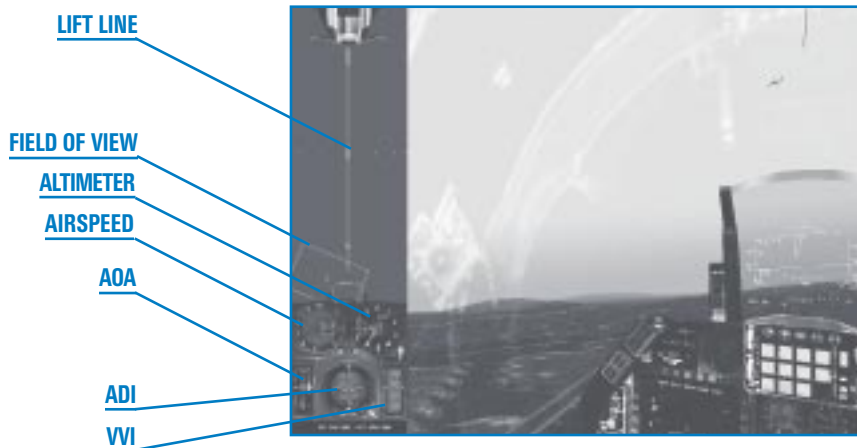

The rectangular box shown on the SA bar indicates the Virtual Cockpit's field of view. The white edge represents the top of the field of view. The little tick marks along the center line of the SA bar indicate degree headings. The first tick indicates 30° looking up. The tick marks halfway up running along the side of the SA bar indicate 0° (red), 15°, 30° and 45° from eye level.

SA BAR INSTRUMENTS

The bottom half of the SA bar shows critical instruments. Read more about these instruments in **Chapter 17: Consoles**.

- ✦ Airspeed indicator
- ✦ Altimeter
- ✦ AOA (Angle of Attack) indicator
- ✦ ADI (Attitude Direction Indicator)
- ✦ VVI (Vertical Velocity Indicator)
- ✦ Speed brakes ("PCT BRK")
- ✦ RPM setting ("PCT RPM")

PADLOCK VIEW

Padlock view enables you to visually lock onto targets and track them continuously until they are directly in front of your aircraft. This view is only effective when targets are within visual range or when you've locked onto a target with your radar. If your radar is locked onto a target or your HUD has a target in visual range (either friend or foe), press **[4]** on the top row to visually lock a target in Padlock view.

Padlock view works in conjunction with three targeting modes to provide a constant visual fix on the greatest perceived threat. Press **[Enter]** for A-A (Air-to-Air), **[Backspace]** for A-G (Air-to-Ground) or **[V]** for navigation. You can also press the corresponding ICP (Integrated Control Panel) button.

Press **[4]** repeatedly to cycle through the targets within range of Padlock view. Padlock will not work if the target falls outside the camera range for more than four seconds or is blocked by your aircraft.

Note that the SA bar is available in both the Padlock and Virtual Cockpit views. Press **[Shift][3]** in either view to display the SA bar.



Padlock Realism Settings

The capabilities of Padlock, Virtual Cockpit and EFOV (Extended Field of View—see below) are determined by the Padlock setting in the Simulation setup. The Enhanced setting selects targets according to threat and distance; the Realistic mode setting selects targets according to field of view, threat and distance. In Realistic mode, padlock can only lock onto items in viewable range, which is a 60° by 60° area. This “viewable range” corresponds with what your eyes can see. When you press the Padlock key, a yellow TD (Target Designator) box will jump from target to target. One second after the last key press, the view will padlock onto the last selected target and the TD box will turn red.

Keep in mind that the radar and padlock are two separate things. Padlocking only works within 8 nm, whereas your radar can, of course, lock onto a target beyond this range. The only exception to this rule is when you have radar lock on a target. The padlock will stay on this target regardless of range. The padlock will break lock once the object is outside the viewable range or in a blind spot for longer than 3–5 seconds.

Threat Levels and Target Acquisition

When a target appears, press **[4]** repeatedly to cycle through the threats and targets within Padlock range of your aircraft (8 nm). Remember that if a target is locked up on your radar, you can padlock it at a distance further than 8 nm. Padlock view prioritizes targets according to their threat level, proximity and the targeting mode you are using (A-A, A-G or NAV). The more dangerous an object, the greater the chance that it will be the first lock you encounter when you start to padlock.

Target threat levels differ depending on the targeting mode you are using (A-A, A-G, or NAV). The following objects are the order in which they will be padlocked:

AIR-TO-AIR PADLOCKING PRIORITIES

- ♣ SAM missiles
- ♣ Enemy aircraft you have locked up on your radar



- ✦ Aircraft firing upon you (ranked by proximity)
- ✦ Enemy aircraft painted by your radar
- ✦ Enemy air threats

AIR-TO-GROUND PADLOCKING PRIORITIES

- ✦ SAM missiles
- ✦ Targets locked on radar
- ✦ Enemy vehicle firing
- ✦ Enemy vehicles painted by your radar
- ✦ Enemy vehicles

NAVIGATION PADLOCKING PRIORITIES

- ✦ Friendly airbases and runways
- ✦ SAM missiles
- ✦ All other threats per A-A padlocking priorities

EXTENDED FOV VIEW

Press **[5]** on the top row to switch to the Extended Field of View (EFOV). The Extended FOV looks like the HUD Only view, but EFOV enables you to see the target and its location while looking directly ahead in your aircraft. If no target is selected, you will only see what looks like the HUD Only view. You can display up to four MFDs the same as the HUD Only view.

The Extended FOV view enables you to lock onto targets and track them continuously until they are directly in front of your aircraft. If your radar or HUD has a target in view, press **[5]** to lock onto a target and cycle through other targets.

If an enemy aircraft or other target briefly appears in the front 60° of your aircraft, then disappears to one side (an occurrence common in dogfights), the EFOV target tracking window will appear at the bottom of the screen and continue tracking the target. The target ID is displayed at the bottom of the target tracking window. Green arrows also appear onscreen pointing in the direction of the target. EFOV follows the same rules of visual acquisition as Padlock view.



EFOV TRACKING WINDOW

OUTSIDE VIEWS

Outside views provide better situational awareness and a different perspective on your world.

VIEW CONTROLS

You can zoom and pan around in almost all of the outside views. Press **[1]** on the numeric keypad to zoom in or **[7]** on the numeric keypad to zoom out.

In the outside views, pressing the arrow keys on the numeric keypad pans the camera around. Press **[↑]** to move the camera up, **[↓]** for down, **[←]** for left and **[→]** for right.

SATELLITE VIEW

Press **[~]** on the top row to access this overhead view of your aircraft. You can zoom, tilt and pan around your aircraft from above, but you cannot move below the horizontal plane of your aircraft. In Satellite view, your aircraft is always at the center of the screen.

ACTION VIEW

[Shift][~] pulls up Action view, a roving camera that shows dynamic views of the action in the game.

TRACKING VIEW

Press **[6]** on the top row to access Tracking view. Unlike Satellite view, which simply places your aircraft in the center of the screen, Tracking view provides an exterior view of your aircraft from a viewpoint that always includes the target. In other words, Tracking view always displays you in relation to your target. Each time you press **[6]**, you step to another target, with the perspective always rotating around your jet and looking through you to watch the other object.



ENEMY VIEW

Enemy view provides a similar arrangement to Tracking view, but from the viewpoint of the enemy. Press **[Shift][6]** to bring up Enemy view.

INCOMING VIEW

Press **[7]** on the top row to switch to the Incoming view, which provides a picture from the viewpoint of a missile that's aimed at you.

WEAPON VIEW

Press **[Shift][7]** to show the view your missile sees after it is launched.



WEAPON'S TARGET VIEW

Press **[Alt][7]** to display the target of your missile; this view is similar to Enemy view.

FRIENDLY VIEW

Press **[8]** on the top row to cycle through views from all the friendly aircraft in the area.

FRIENDLY GROUND UNIT VIEW

Press **[Shift][8]** to see views from friendly ground forces.

CHASE VIEW

Press **[9]** on the top row to switch to Chase view. Chase view is directly behind your Falcon.

FLYBY VIEW

Press **[Shift][9]** to see a view of your aircraft from a fixed position in space as it flies by.

ORBIT VIEW

Press **[0]** to access Orbit view. This is a very flexible way to look around your aircraft from outside the cockpit.

OTHER VIEW FEATURES

Falcon 4.0 includes other view functions that provide helpful visual cues during flight.

LABELS

Turn Labels on in the Simulation setup screen or else you cannot toggle labels on in the simulation. When Labels is checked, every military object (including planes, ground units, SAMs and ships) is tagged with its name. Press **[Shift][L]** to display labels for nearby vehicles within engagement range. Press **[Ctrl][L]** to turn on far-away labels, which adds labels for all vehicles outside normal range. Note that you must first press **[Shift][L]** to turn on labels before pressing **[Ctrl][L]** to include faraway objects.

The color scheme for labels differs for each of the different game modes.

Mode	Identifying Colors
Instant Action	Red = Enemy, Blue = Friendly, Green = Neutral
Dogfight	Red = Crimson, Blue = Shark, White = USA, Orange = Tiger
Campaign	Blue = Forces friendly to South Korea, Red = Forces friendly to North Korea

CANOPY REFLECTIONS

Turn on Canopy Reflections by selecting it from “Canopy Cues” in the Graphics setup screen. Use the reflections you see of your suit and instruments to keep yourself oriented as you look around. We only recommend turning on “Canopy Reflections” if you have a 3-D graphics accelerator; otherwise, the sim’s graphics will slow down significantly. The lift line is a good substitute for canopy reflections.

LIFT LINE

Turn on the lift line by selecting it from “Canopy Cues” in the Graphics setup screen. Turning on the lift line displays a long line on the canopy with arrows pointing toward the nose of your aircraft if you are in the 2-D Cockpit, Virtual Cockpit and Padlock views. The lift line cue gives you a frame of reference while you are looking up. The arrows point toward the front of your cockpit (three arrows near the back, two in the middle and one near the front).

GLANCE FORWARD AND GLANCE BACKWARD

Press **Enter** on the numeric keypad to glance forward in the 2-D Cockpit, Virtual Cockpit and Padlock views. Press **3** on the numeric keypad to glance backward. Glance forward to look quickly out the front onto a target without breaking the visual lock on the target when you are padlocked. Glance backward to check your six. As soon as you release the key, your view will revert to its original orientation.

LOOK CLOSER

Press **L** to toggle Look Closer, which provides a close-up view. Use this key in any view to zoom in on your view.

NIGHT VISION

Press **N** to activate the NVG (Night Vision Goggles). NVG are helmet-mounted goggles that amplify ambient light. NVG allows for 360° viewing because it is mounted on your helmet. The FLIR (Forward Looking Infrared), on the other hand, can only provide night vision looking forward and is not usually available on the F-16.

REDOUT AND BLACKOUT

Your view will change significantly if you pull positive Gs or negative Gs. In a positive G situation, the weight of gravity pulls blood down toward your feet, causing a blackout. In negative Gs, blood rushes to your head, causing blood vessels to burst and eventual unconsciousness. Read **Chapter 25: Aerodynamics and G Forces** for more information.

CHAPTER

23



RADIO
COMMANDS

Falcon 4.0 has literally thousands of different radio commands. This chapter deals only with the two-way radio call feature of the simulation. In *Falcon 4.0*, you can call, or receive radio calls from, the following sources:

- ✦ AWACS (Q key)
- ✦ Flight (R key)
- ✦ Wingman (W key)
- ✦ Tower (T key)
- ✦ Element (E key)
- ✦ Tanker (Y key)

Two-way radio communication is possible with any of these entities. You can receive radio calls from other aircraft, but you cannot direct calls to any other entity except the ones listed above.

Press the number key corresponding to the radio command to make that radio call. Some radio command menus have more than one page. To switch to the next page, press the key command again (such as Q for AWACS). To return to the previous page, press Shift plus the key command (such as Shift Q for AWACS). To exit the radio command menu, press Esc. If a radio command is grayed out, it is not available in that situation. For more information about radio calls, see **Appendix B: Glossary**.

AWACS RADIO COMMANDS

The AWACS radio commands are used to ask or reply to AWACS (Airborne Warning and Control System). AWACS aircraft control aerial engagements, and provide you with superior radar information and a “big picture” view of the battle. This picture can be very valuable to a pilot, but just like the real AWACS, the AWACS in *Falcon 4.0* does not always have a complete picture of the fight. This means that AWACS may not always tell you about a serious threat that is about to ruin your day. If you rely on AWACS to be omniscient, you may pay for it with your life.

AWACS PAGE

The AWACS radio commands are divided into two pages. Press Q to bring up the first AWACS page. Switch between the pages by pressing Q and Shift Q.

Request picture asks AWACS for a “picture,” or the position of the nearest threat aircraft. AWACS will either reply with vectors to the nearest threat, or will call “Picture clear” if no threat aircraft are present in your area.

Declare is one of the most useful radio calls in an air battle. Use “Declare” to ask AWACS to identify a radar target as either enemy or friendly. First, lock onto a target with your radar. Then “Declare” the target to AWACS, which will now try to identify the target as hostile (a bad guy), friendly or unknown.

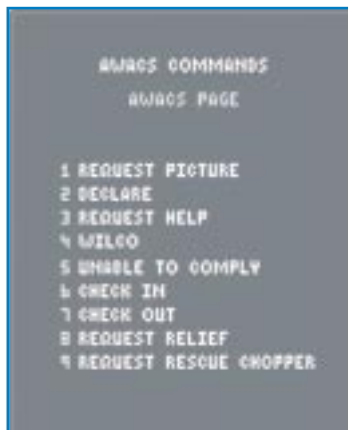



Request help is used when you or your flight is in trouble, most often when you are being overwhelmed by enemy aircraft. When you request help, AWACS will try to vector nearby aircraft to aid you if possible.

Wilco (short for “Will comply”) tells AWACS that you can comply or perform the task that is being asked. For example, if AWACS asks if you can divert to help another flight that is in trouble, respond with “Wilco” to inform them that you will go help. You can also press **[Shift]Y** for “Wilco.”

Unable tells AWACS that you cannot do the task that is being asked of you. You can also press **[Shift]U** for “Unable.”

Check in is used when flying CAS (Close Air Support) missions. When you get close to IP (Initial Point), “check in” to get a CAS target from AWACS.

Check out tells AWACS that you plan to discontinue your CAS mission (because you have no more weapons, for example).

Request relief is a very important AWACS call. BARCAP (Barrier Combat Air Patrol) and DCA (Defensive Counter Air) missions require you to stay “on station” for a specific period of time. If you leave before that time expires without permission from AWACS, you will not successfully complete your mission. “Request relief” asks AWACS if you can leave your BARCAP or DCA location and return to base.

Request rescue chopper gets a rescue chopper to your location after a friendly aircraft is shot down. AWACS will note your position and try to send a chopper to find the downed airman.

VECTOR PAGE

Vector radio calls get you pointed at a specific location. When you use a vector radio command, AWACS will respond with a bearing and distance to the location that you requested, such as “Tanker is 120° for 25 miles.”

Below are descriptions of the locations or entities for which you can request vectors:

Nearest threat is a very valuable AWACS call that is similar to “Request threat picture.” This call, however, is more specific and AWACS should give you a bearing and range to the closest enemy aircraft.



Target refers to your air-to-ground target. This call can be very helpful to help you find your air-to-ground target if you have systems malfunctions or are just plain confused.

Package is the group of flights that are all flying the same route to the same target area. Normally you are part of a large package or group of flights. You can get vectors back to this group or package by asking AWACS for vectors.

Tanker refers to the orbiting airborne tanker, which is airborne most of the time in *Falcon 4.0*. Ask AWACS for vectors to the tanker to get a bearing and range to it.

Divert field is the airfield you use when you can't land at your primary or "home" airbase. Getting vectors to the abort field is important when you are low on gas and your home airbase is under attack or destroyed.

Home plate is the airfield from which you departed.

FLIGHT RADIO COMMANDS

The next set of radio calls is for communication with your flight. *Falcon 4.0* has two basic formations: a two-ship and a four-ship. If you are flying in a four-ship formation, you basically have a wingman and the other element. The figure below shows a four-ship formation with the player as the #1 man in the four-ship.

A four-ship is divided into two elements. The #1 man leads the entire four-ship and is also in the lead of the first element. The #3 man leads the second element but must follow the instructions of the #1 man or flight lead. *Falcon 4.0* breaks down radio calls into wingman, element and flight. Wingman calls affect only a single aircraft. Element calls affect the

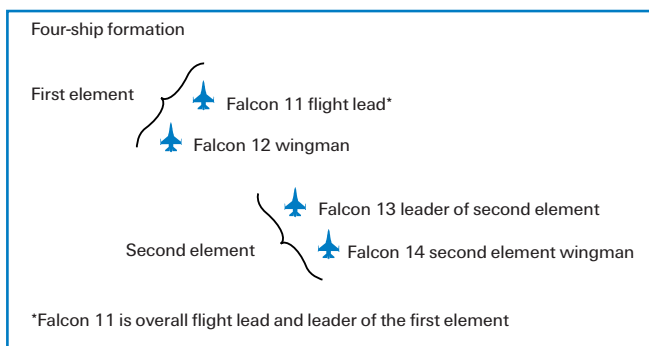

second element or the other two-ship in the flight. Flight calls affect everybody: your wingman along with the other element. In *Falcon 4.0*, radio call menus are the same for wingman, element and flight, even though some of the formation calls are four-ship specific. If you give a four-ship formation command when you are flying in a two-ship formation, your wingman will fly his normal two-ship position for the four-ship formation. For example, a box formation is a four-ship formation with each flight member at a corner of the square. If you give this radio call to your wingman only or to a two-ship flight, your lone wingman will move into his correct position in the box formation—even though he is the only one in the formation.

Press **W** to display the Wingman radio commands, **E** for the Element radio commands and **R** for the Flight radio commands. Switch between pages by pressing the same key command or **Shift** plus the key command.



COMBAT MANAGEMENT PAGE

Attack my target directs flight members to attack a specific target.

The key is to know how to determine what target is “my” target.

The position of the radar cursors is used to determine what target you want your wingman (or element or flight) to attack.

Another way to determine the target is to have a radar lock-on. If the radar is locked on and you say, “Attack my target,” the directed flight member will attack the locked target.

Buddy spike tells another aircraft that you are a friendly and is especially useful when flying in multiplayer. If your wingman

locks his radar onto you, you will hear a distinct F-16 threat

warning tone. When you hear that sound, call “Buddy spike” which tells him that he is locked onto a friendly. For example, you get separated from your multiplayer wingman during an engagement. He is looking for you on radar and sees a target. He locks onto the target and calls “Fury 12, Raygun bullseye 320, 100 miles.” This means that he has locked onto a target that is 320° and 100 miles from bullseye. If you are locked up by an F-16 radar at about the same time of the “Raygun” call and are at the same bullseye position that is being called out, respond with “Buddy spike.” This call can be used anytime a real or computer-controlled F-16 locks up on you.

Raygun broadcasts that you have locked up an unknown air-to-air target and want to know if it’s a friendly (for example, “Fury 12, Raygun, bullseye 320 for 100”). The expected response if you are at that bullseye position is “Buddy spike.”

Weapons free “frees” up or gets your computer-controlled flight members to shoot weapons when within parameters. AI pilots are always in a “weapons hold” state until you give them this radio command or one of the attack radio calls such as “Attack my target.”

Weapons hold stops your flight members from firing weapons. The computer-controlled pilots always default to the weapons hold mode. Use this command to tell the AI pilots to stop shooting or dropping bombs after you have given them an attack command or a “Weapons free” call.

Check your six asks your wingman to make a series of turns so that he can check his 6 o’clock position.

Clear my six asks your wingman to make a turn behind your jet to check your 6 o’clock position. This call is useful if you have a bandit that is closing in behind you since your wingman should detect this type of attack and engage the bandit after you give this radio call.



FLIGHT COMMANDS
COMBAT ARRANGEMENTS 2

- 1 REJOIN
- 2 RUN SINGLE-SIDE OFFSET
- 3 PINCE
- 4 POSTHOLE
- 5 CRUISEAW

Rejoin requests the selected flight member to return to the formation. It is most often used after giving a call to a flight member to attack or clear your 6 o'clock.

Run single-side offset is a stern conversion air-to-air attack. The purpose of this attack is to get the designated flight member to run an intercept and get to the enemy aircraft's 6 o'clock..

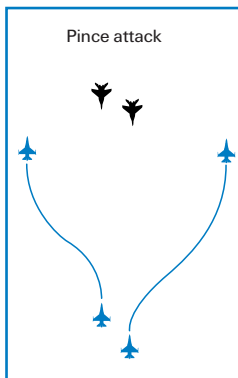
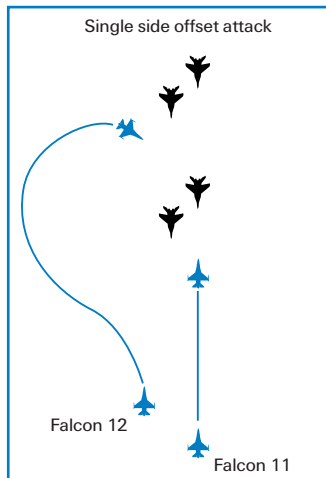

Pince is an attack command used to get your wingman, element or flight to pince or bracket the target. The pince will be run on whatever air-to-air or air-to-ground target you have locked up. If you do not have a lock-on, it will be the target under the radar cursors.

Posthole is the same as the pince attack except it is in the vertical rather than the horizontal plane. In addition, a posthole is only used to attack aircraft targets. This attack will be run by a flight member on whatever target is locked up or is under your cursors.

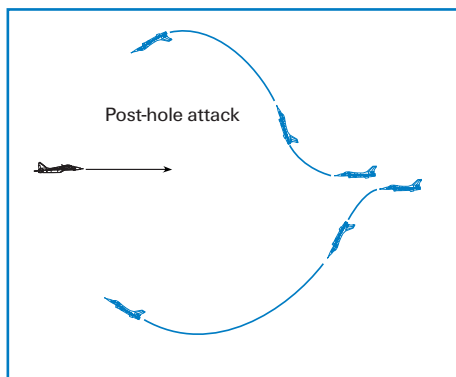



Chainsaw is a specific attack using the AIM-120 AMRAAM missile. This attack will be run on whatever target is locked up on the radar or is under your cursors. On this attack, your flight members will fly towards the designated target and fire an AMRAAM missile. When the missile goes active or can guide to the target using its own radar, the flight members will turn away from the target and rejoin with your flight. The chainsaw is a simple launch-and-leave attack using AMRAAMs.

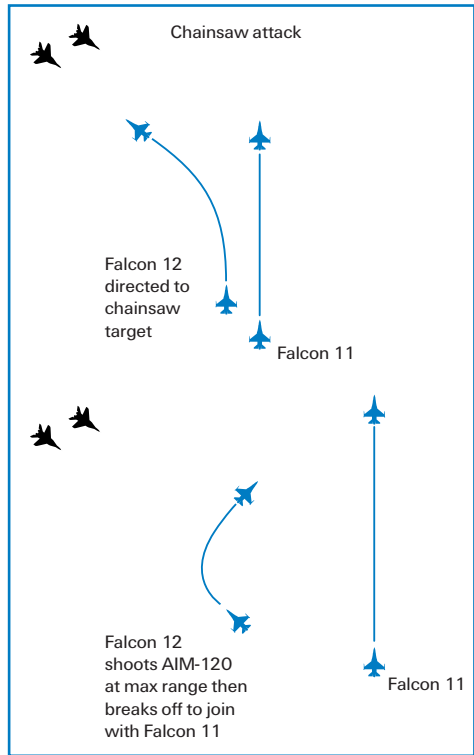

MISSION MANAGEMENT PAGE



Resume mission asks your flight members to return to the primary course of action. If you are inbound to bomb a target and you send your wingman to attack an inbound enemy aircraft, “Resume mission” will get him to come back with you and continue on the mission.

Return to base asks a flight member to return to the home airfield.

Radar to standby tells your flight members to switch their radars to standby. This call is useful if you have turned your radar to standby to avoid detection and you want your wingman to do the same.

Activate radar simply undoes the “Radar to standby” call. All computer-controlled aircraft have their radars on until they are told to turn them to standby. Once in standby mode, they will leave them there until told to “Activate radar.”

Say position asks a flight member to tell you where he is in relation to your aircraft or bullseye. The format will depend on what you have selected in the Simulation setup. If you do not have bullseye selected, the computer-controlled flight member will answer this call by giving you a magnetic bearing and range.

Say damage asks a computer-controlled wingman to report the extent and nature of his battle damage.

Say status requests your flight members to report what they are currently doing. Examples include "Engaged offensive," "Engaged defensive" and "Engaging target 040 for 5 miles."

Say fuel asks your computer-controlled wingman to report his available fuel. This call is made in pounds. For example, a wingman might answer, "Cobra 12 has 2,700 pounds."

FORMATION MANAGEMENT PAGE

Kickout asks a flight member to move farther out. This call does not change the formation, just the formation spacing. For example, if you have your wingmen in spread formation at about 6,000 feet and want them to move out further, radio "Kickout."

Close up does the opposite of "Kickout." When you tell a flight member to close up, they move in closer in no matter formation they were in.

Go spread moves the flight into a spread formation as shown below. This formation is excellent for penetrating a high threat area because the flight goes through the threat envelope simultaneously, which forces the bad guys to pick a single target. The spread formation is also appropriate when your computer-controlled flight members will fire air-to-air or air-to-ground missile shots; "Go spread" will keep those shots away from your jet.

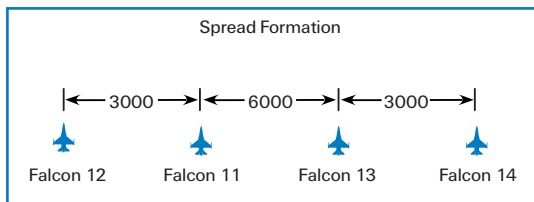



Go arrowhead moves the flight into the arrowhead formation, which is a variation on the box formation. (A legendary F-4/F-16 pilot whose callsign was “Joe Bob” developed this formation, so for a time it was called the “Joe Bob” box.) The arrowhead is an excellent formation to fly in multiplayer with a real wingman because the trailing digital element can clear your 6 o’clock while your real wingman can stay in close to your jet. This formation is good for both air-to-air and air-to-ground missions at all altitudes.

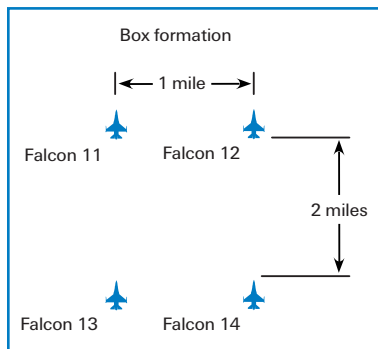
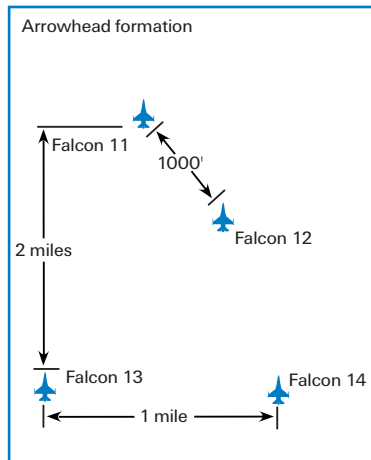

Go box moves the flight into the box formation shown below. The box formation is good for low altitude ingress. The formation is easy to maneuver and provides great 6 o’clock coverage for the flight. In addition, the trailing element can easily provide support to the lead element if the lead element is engaged. Box is also a good air-to-ground attack formation since there is built-in spacing between elements.

Go res cell moves the flight into the res cell formation shown below. This formation hides the number of aircraft in your formation in an air-to-air fight and is useful when you are outside of about 20 miles from enemy fighters. You should not be in res cell, however, when you enter a turning fight because too many jets are packed together.

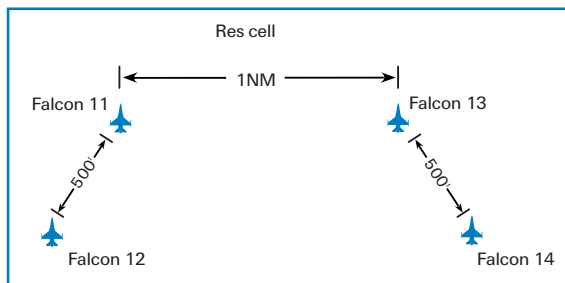

Go wedge moves the flight into the wedge formation as shown below. Use the wedge formation when you anticipate a lot of high-G maneuvering. This formation will keep the flight members from coming into conflict with each other. The wedge formation is also very good for air-to-air attacks when you are planning to split up a four-ship flight. This is not a good high-altitude formation for shooting radar missiles, though, because the second element is in trail and will have to fire missiles through your position.

FLIGHT COMMANDS
FORMATION MANAGEMENT

- 1 GO WEDGE
- 2 GO TRAIL
- 3 GO LADDER
- 4 GO STACK

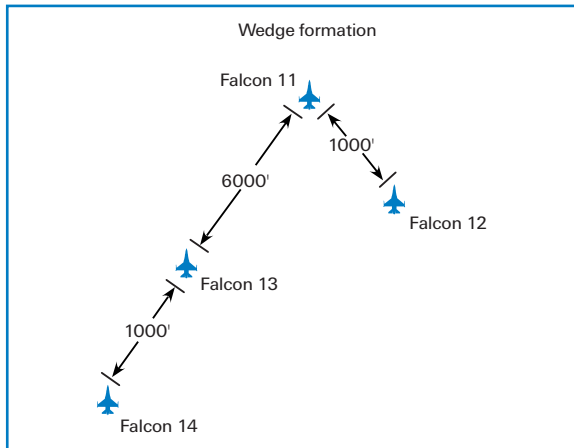

Go trail moves the flight into the trail formation shown below. Trail is used exclusively for air-to-ground attack. The problem with trail in an air-to-air situation is that the trailing aircraft is not being supported by any other jet in the formation. The trailing aircraft is, therefore, very vulnerable to enemy fighters.

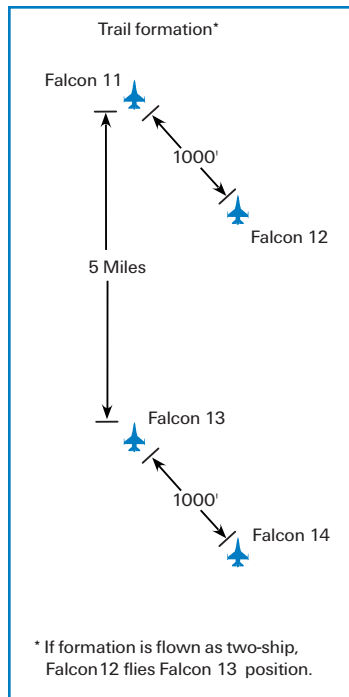

Go ladder moves the flight into the ladder formation shown below. The ladder formation is very similar to trail in its application. This formation should be used primarily to attack ground targets. By having all of the flight members come in at different altitudes, you complicate things for the defenses.

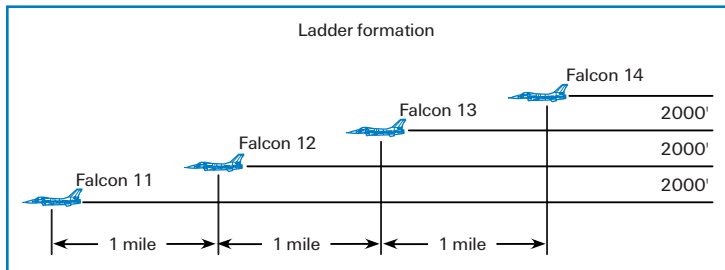

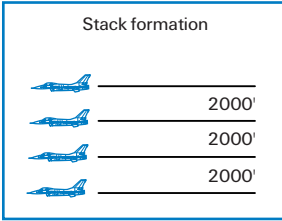

Go stack moves the flight into the stack formation shown below. A stack formation makes it difficult for enemy fighters to sort and attack your formation. The disadvantage of this formation, however, is that it is very difficult to maneuver. In addition, it is hard for fighters in a stack formation to provide mutual support to each other because of the altitude difference.

IDENTIFICATION MANAGEMENT PAGE

Turn smoke on requests your wingman to turn on his smoke trails, making it easier for you to identify him.

Turn smoke off asks your wingman to turn off his smoke trails.

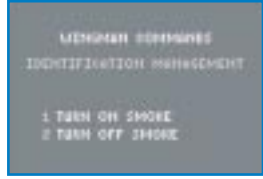

TOWER RADIO COMMANDS

Falcon 4.0 features a detailed ATC (Air Traffic Control) system, and the tower radio commands are used to trigger the system. Press **T** to display the Tower radio commands.



Inbound starts the ATC recovery procedure. When you are approximately 30 miles out from the field, use this call to inform ATC that you are inbound for landing. They will then vector you to the runway. Keep in mind, however, that they are also vectoring other recovering aircraft to land, so try to follow their directions precisely. If you use this call, you will be sequenced into the recovery flow in the order that you arrived back to the field.

Request landing asks the tower if you can land on the runway. If you land without getting permission from the tower, you may come into conflict with another aircraft that is trying to land or take off. Keep in mind, however, that at times the tower will clear you to land automatically (usually when you are being vectored to final by ATC). You do not need to request clearance in that situation. If you are on final approach and you have not been cleared to land, however, use this call to ask for permission.

Declaring an emergency is the same as "Request landing" except that you will be given landing priority over all other aircraft. Use this call to get on the ground fast if you are low on fuel or have a sick jet.

Request taxi is used when you start the game in the taxi position. If you start on the parallel taxiway, ask the tower for permission to taxi out onto the runway. The tower will tell you to "Hold short" if it wants you to stay off the runway, or will say "Taxi into position and hold" if it wants you to get out onto the runway. Once you are in position on the runway, the tower will automatically clear you for takeoff.

TANKER RADIO COMMANDS

The tanker calls are used to help you get fuel. Press **Y** to display the Tanker radio commands.

Request fuel tells the tanker that there is an aircraft that wants to refuel. The tanker will set a steady speed, limit its maneuvering and enter a wide racetrack pattern. All attempts to refuel should start with this call. The tanker will acknowledge your call and tell you are cleared into the “precontact” position which is a few ship widths back from the air refueling boom.

Ready to take fuel is used after you are stabilized behind the air refueling boom. Once you make this call and drive into position, the tanker will attempt to hook up to your jet and pump gas.

Done refueling tells the tanker that you are leaving the air refueling track. After you make this call, the tanker is no longer airspeed and altitude restricted.



CHAPTER

24



AIRPORT
OPERATIONS

If you think the mission's over once you've dropped your bombs and headed for home, *think again*. As a fighter pilot, you are merely one small part of a huge theater of operations. That means getting airplanes in the air and back on the ground must happen efficiently. If departure or recovery operations get fouled up at any of the bases, it will delay some packages from making their missions on time and will leave other members of a package out in enemy territory without the added support of their whole package.

This chapter covers the procedures for getting you and your flight members in and out of your airbase. Since several other missions could be departing or recovering within a short period of time, follow ATC (Air Traffic Control) procedures to keep airport operations running smoothly. If problems occur, you also need to know what to do to get yourself onto the ground safely.

GROUND OPERATIONS

Missions in Tactical Engagement and Campaign begin either on the ground or in the air. In Campaign, if you select a mission that has not yet taken off, you will begin your mission on the ground and you can start from taxiing or directly from takeoff. Once you select and set up your mission, load your ordnance and get your flight briefing, it's time to climb into your jet and execute a combat mission from start to finish. Select the Fly icon to start the mission.

Select Takeoff to be placed on the runway at your takeoff time ready to launch. Consider yourself cleared for takeoff, so "light the wick" and get on your way. Other aircraft will be trying to land or be waiting to take off.

Select Taxi to begin right in the thick of ground operations at a combat airbase. Your flight can be in line with other packages getting ready to take off and other aircraft returning to land. As you start taxiing, you will be cleared to "taxi in sequence" and the tower may give you a sequence number for departure. If nobody in front of you delays getting onto the runway, then you should be able to taxi with the flow of aircraft and get cleared for takeoff in time to make your mission.

The actions of aircraft on the airfield can affect the package flow of your flight and that of other packages, preventing them from making their missions on time. If you get out of the taxi flow and waste time driving around the airfield, expect the tower to ask you what's going on. If you delay too long and you cannot catch up with your package to make your mission on time, your flight will be canceled by the mission director. A computer-controlled aircraft will take over for you and you'll be heading back to the squadron with your tail between your legs, looking for another mission to fly.

DEPARTURE

Once you are "#1" for takeoff (the next aircraft to take the runway), you may be directed to "hold short," probably for landing traffic. If so, you can taxi up to the edge of the runway—but don't enter it unless you want someone on final approach to put his landing gear through your canopy. You also might be cleared to "position and hold." If you hear this, taxi onto the runway and hold



your position for takeoff. Someone else probably hasn't cleared the runway yet. As soon as you are "cleared for takeoff," you are expected to get on your way to do your part in pounding your enemy into the dirt. Don't waste any time getting in the air, especially if the tower tells you to "expedite" your departure.

Once you are airborne, select and fly to the next steerpoint on your route so you can meet up with other flights in your package and make your time on target. Since you no longer need to talk to ATC, change radio channels to monitor your enroute frequency and begin listening to AWACS and other flights involved in the battlefield.

You do need to get your flight rejoined for the mission. Once safely airborne, the flight lead will accelerate to 350 knots (the standard airspeed for departure) and then pull his power back slightly. This gives the other flight members a chance to join up and get into the proper formation. Once the flight is joined up, you can then maintain whatever speed you need to make the timing work on your mission.

RECOVERY

The mission isn't over until you get your aircraft on the ground safely so that it can be prepared for the next flight. You could very well be returning to your base at the same time as several other packages. This means ATC has to sequence all of this traffic into the airfield for a smooth recovery of aircraft. If you decide to blunder straight into the field without getting clearance to land, you could cause traffic conflicts with other aircraft being sequenced on the approach—and you can at least expect to hear about it from the tower.

As you head for home, make sure your TACAN is set with the right channel for the airfield you are set for recovery. Since hopefully you're to land at the same base you took off from, you shouldn't have to change the TACAN channel. Not only will this help you navigate back to the right field, but it keys your radio into the right approach controller for your airfield. You certainly wouldn't want to receive vectors from the Osan airbase controller when you are trying to land at Chungju! For more information, see "Navigation System" in **Chapter 17: The Consoles**.

APPROACH PROCEDURES



To recover back at your base, you first need to contact Approach Control (press **T** for tower) and let them know you are inbound to land. ATC monitors the general area within 30 nm around each airbase to sequence the landing traffic with aircraft waiting to depart. If you try to contact ATC too far from the field, you will be notified that you are "outside of their airspace" and to contact them when you reach 30 nm from the field. If you wait until you are too close to the field to call Approach, then things will get extremely busy and confusing as ATC tries to vector every one of your flight members (along with whomever else is arriving to land) all at once.

Even with everything flowing smoothly, things can get busy as you're returning to the field, so here are the procedures to follow to help ATC manage the flow of aircraft during the recovery.

Contact Approach for landing about 30 nm from the base. If your flight is returning to the base together, then Approach Control knows that the flight lead's "inbound to land" call applies to the whole flight. (Each member of the flight can still make the same request, but it isn't necessary.) If your flight has been separated during the mission and you are returning to base at different times, then go ahead and make your own call to approach when you recover to the field.

If you are returning to the field by yourself, Approach should tell you to "continue inbound" and expect vectors to final. If you are part of a flight returning together, Approach will also advise you to "take spacing." Each member of the flight will eventually be given individual vectors to final when you get closer to the field. If you can get some separation between flight members sooner, you won't be receiving vectors for everyone at the same time.

"Taking spacing" during the recovery simply means to begin spreading your flight out as you continue inbound toward the field. The flight lead should maintain airspeed while the others slow down. Once they get some distance behind the flightmate in front of them, they can then resume their original airspeed. Here's an example. You're in Hammer 1 flight heading into Osan airbase at 350 knots. At 30 nm from the field, Hammer 11 calls up Approach requesting to land. Approach tells the flight to continue inbound and take spacing. If you are Hammer 11, maintain your speed while the other flight members slow down about 50 knots. If you are Hammer 12, wait about a minute after you've slowed down and then speed back up to 350 knots. This should put you about a mile behind Hammer 11. If you are Hammer 13, then slow down for about 2 minutes before resuming your speed, putting you about a mile behind Hammer 12 (and 2 miles behind Hammer 11). If you are Hammer 14, slow down for about 3 minutes.

Don't worry if you don't have time to do this or if you get vectored before you have time to spread out. Approach will still give each of you vectors to sequence you into the field. Once that happens, you don't have to worry about your other flight members; just follow ATC's instructions.

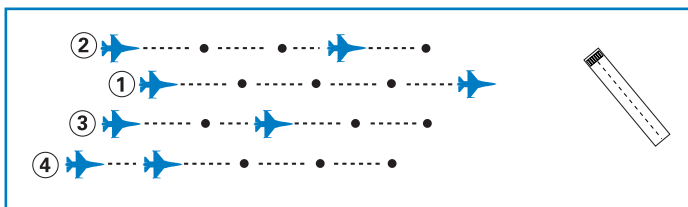

Approach Control will assign you a specific vector and airspeed to fly the approach pattern. For fighter aircraft, pattern airspeed will usually be around 250 knots, but Approach Control could adjust that for pattern sequencing. If all the fighter aircraft in the pattern maintain a fairly consistent airspeed, it will help Approach sequence aircraft in for landing much more efficiently.

If Approach determines no landing slot is available at the moment, you may be directed to "orbit" while Approach finds the spacing to fit you in and gives you further clearance. This could also happen if you fly so far off your assigned pattern you get yourself out of sequence for landing in



the traffic flow. In this case you'll want to get out of the way of other traffic, so make a turn away from the airfield and set up an orbit to hold while you wait for Approach to resequence you back in for landing. Do this by making 360° turns at 250 knots with about 30° of bank and continuing the orbit until Approach Control gives you new vectors for the approach. Once it does, just continue your present turn until you can roll out onto the assigned heading. Then follow instructions in for landing.

Once Approach begins to give you vectors, expect to be flown around a ground track resembling a standard traffic pattern (see the figure below). If you are mostly lined up with the active runway as you approach the field, you might simply be given vectors straight in for a landing. If your position is near 90° off the end of the runway, you will probably enter a base leg (near perpendicular to the final approach course) before getting turned down final.

If you are coming from the opposite direction of the active runway, expect to fly a downwind leg parallel to the runway until getting turned to a base leg and then down final. Remember, since Approach might be sequencing you into the flow of any number of recovering aircraft with different vectors, the traffic pattern won't always look the same each time you return to the field.

Remember, in this combat theater of operations, the job of Approach Control is simply to help sequence aircraft for recoveries and takeoffs. (Don't count on them to land your plane for you!) You've still got to fly the jet down the approach and get it on the ground safely, so refer to **Chapter 3: Landing and Navigation** if you still need practice with landing.

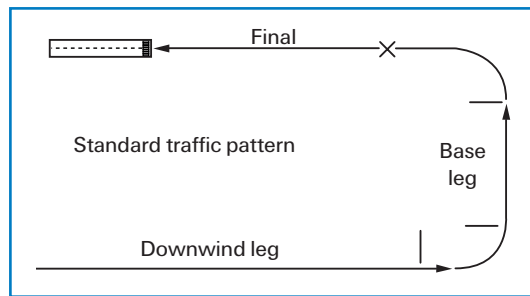

As Approach Control gives the last call to line you up on the final approach course, it will advise you to slow to approach speed. This is a good time to drop your landing gear, pull the power back and slow down from your pattern airspeed. This is also the time when Approach Control will hand you off to the Tower Controller.

FINAL APPROACH

As you continue down the final approach, the tower will give you a call either letting you know what your sequence is for landing (such as "You are #2 for landing") or giving you clearance to land if you are the next one down and the runway is open. The tower will also give you an advisory call to make sure your landing gear are down.

For help in flying the approach at your destination, refer to **Appendix C: Airport Maps**.

LANDING

If you have followed Approach Control's vectors, you should be lined up with the final approach course. As you make the turn to final is a good time to lower your gear and begin slowing down. Then at 6 nm from the field, begin your descent down final as you intercept the 3° glide slope.

Make sure your speed brakes are out. Pull your power back to reduce your airspeed until you are flying at an 11° AOA approach speed. (This speed varies depending on how much fuel and stores you still have on the aircraft at the time.) As you fly down final, your flight path marker should be at 3° on the HUD pitch scale and sitting on the end of the runway. If you are on a glide slope that is too steep (flight path and touch down zone below 3° on the HUD scale), then push the nose over to get back on glide slope and reduce your power to control your airspeed. If you are too shallow, then level off or climb until you intercept the 3° glide slope again.

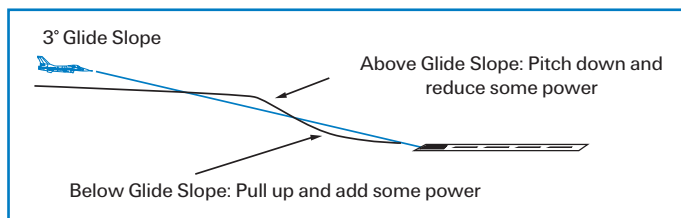

It will be much easier to land if you can keep the jet on a stable glide slope and airspeed. This will help you judge your height above the ground and determine when to flare. As you approach the runway, keep the flight path

marker on the landing end of the runway until you flare. When you get over the end of the runway, pull your power to idle and ease back slowly to begin the flare. Let the jet settle to the runway, slow to taxi speed and clear the runway quickly, as other traffic is landing or waiting to take off.

EMERGENCIES

Remember, this is a combat environment. What happens if your airfield is attacked and the runway is damaged before you can get back on the ground? Expect the tower controller to divert you to an alternate airbase. Get your gear up and speed brakes closed, start climbing and turn to the divert heading you are given. Don't forget to set the divert base TACAN channel on the way.

What if the runway is closed only temporarily? Then expect to be directed to execute a missed approach or to go around. In this case, however, you will probably be told to contact Approach for resequencing. Give them a call requesting clearance to land, and they should set you up with new vectors to final.

If you are returning to base with an emergency, such as battle damage or low fuel, then tell ATC you are declaring an emergency. Head for the field and get your jet on the ground as soon as possible. Hopefully, you won't close the runway or delay other aircraft from taking off or landing for too long!

CHAPTER

25



***AERODYNAMICS AND
G FORCES***

Before jumping right into this discussion, I want to tell you a story that demonstrates what a fighter pilot needs to know about aerodynamics. I was flying F-16s out of Kunsan, South Korea, and one day I was riding out to the jets in the crew van with my operations officer. We called him "Wolfman" because he was powerful ugly, even by fighter pilot standards. As I glanced over at Wolfman, I noticed he had little arrows drawn on his flight gloves with words written next to them. His right glove had an arrow pointing forward with the words "Houses get bigger" written next to it. The arrow pointing to the back of the glove had the words "Houses get smaller" beside it. On this same glove, he also had drawn left and right arrows with the words "Jet go this way" next to each one. On his left glove, he had drawn two more arrows. The arrow pointing forward read "Jet go faster." The words besides the arrow pointing to the back of the glove were "Jet go slower." When he noticed me staring at his gloves, he just shrugged and said, "Sometimes I just forget." Fighter pilot humor... God help me, I love it.

Anyway, the arrows and words on Wolfman's gloves sum up what a fighter pilot must understand about aerodynamics. Since that's all I know (and I'm currently flying about 10 F-16 sorties a month), I don't think you need to know too much detail about aero either. With the risk of being redundant, though, I will fill in a few details that Wolfman couldn't fit on his gloves.

THE FORCES ACTING ON THE AIRCRAFT

A Falcon pilot should understand the basic forces that act on an aircraft in flight. This knowledge clears up the great mystery of why the pointy end goes through the air first. The figure below shows these forces and their direction in relation to the F-16.

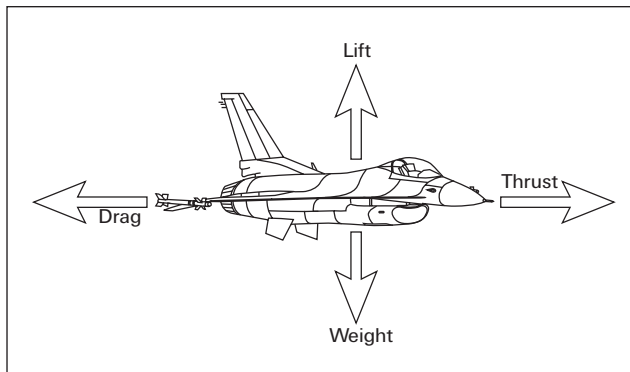



Thrust pushes the plane through the sky and is produced by the aircraft's engine. The working of a jet engine can be summed up as "Suck, squeeze, mix, ignite and blow." The engine sucks air in through the intake, squeezes it in the compressor, mixes the air with fuel in the combustor and ignites it, causing the air to blow out the back of the engine through the nozzle with great force. On the way out the back, this high-velocity air spins turbine blades that power the compressor and the fan blades at the very front of the engine. The nozzle in the back of the engine closes down as you push the throttle up, creating higher velocity air—and thus more thrust. When the afterburner is engaged, fuel is literally sprayed out the aft end of the engine, creating a controlled explosion that is directed out of the open nozzle. The AB (afterburner) produces an enormous increase in thrust. Throttle position controls the amount of thrust that an engine produces by metering the fuel burned in the combustor. Throttle settings are usually measured in percent, with 100% being the highest non-afterburning setting. This throttle position is referred to by fighter pilots as Mil. As you push the throttle up, you simply convert more jet fuel into noise and produce more thrust (and speed). Afterburner uses considerably more fuel.

Lift is a force produced by the aircraft wings (and possibly the body of the aircraft), which acts perpendicular to your flight path, pushing up on the bottom of the aircraft straight out the top of the plane. Modern fighters such as the F-16 use blended wing-bodies to produce a great deal of lift. This allows the wings to be smaller and saves weight.

Drag acts the opposite of thrust. Drag slows your plane and is mainly created in two ways. The first is through basic aerodynamic shape. Pushing anything through the air causes *form drag*. You can reduce form drag by designing an aircraft with a smaller frontal cross section and by using a clean, aerodynamic shape. A dart, for example, has a very clean aerodynamic shape and low form drag, whereas a cinder block has a dirty, high drag shape. The other type of drag is called *induced drag*, which is created whenever lift is generated. The explanation of why induced drag is produced by lift is beyond the scope of this discussion, but I think it has something to do with inverse tangents and imaginary numbers or something. Since I don't have the time to explain (and don't like to show off), just keep one thing in mind. As you turn the aircraft tightly, you are commanding increased lift from the wings and are thus increasing the effect of induced drag. Induced drag is the dominant form of drag when the aircraft is at slow speeds, whereas form drag produces the majority of aircraft drag at high speeds.

You may wonder why a hard turn causes airspeed to bleed off in *Falcon 4.0*. Under G (acceleration caused by turning the aircraft), the effective aircraft weight increases and lift must go up in order to counter the increase. With more lift comes more induced drag, which causes airspeed to bleed off. To counter this, you need more thrust. Unfortunately, aircraft thrust is always limited, which limits the G available and thus maneuverability. This is the reason modern fighters have thrust-to-weight ratios of close to 1/1. High thrust-to-weight ratios allow great maneuverability because they power the aircraft through the effects of induced drag.

Weight is the last force acting on the jet as it pulls the aircraft toward the earth. Weight is a concept that even a fighter pilot like Wolfman can grasp.

G FORCE

G force is the force acting on the jet when the aircraft turns. That's the simple explanation. G force is really acceleration or the change in the velocity vector of the jet. It can be described mathematically, but I'll use the "Wolfman" approach again to help you understand the concept of Gs. Just remember these words: "Jet turns, jet makes Gs. Jet turns harder—jet makes more Gs." It's that simple. Just think of a bucket of water on a rope. If you swing the rope in circles, the water stays in the bucket due to G force. This force, unfortunately, has a debilitating effect on the pilot. Just like the water in the bucket, a force is applied straight down on the top of the aircraft. In the cockpit of the F-16, this force feels like an elephant sitting on you. G force drains the blood from your noggin and, if held for too long, can cause blackouts. The effect of Gs on the pilot is primarily driven by two variables: G intensity (how much G) and G duration (how long you are pulling Gs). If you stay at high Gs for a long period of time, the effect of the G force on the body is tremendous.

Falcon 4.0 models G force by reducing the pilot's field of view. This simulates the difficulty you'd have turning your head under high Gs. When you pull Gs in the jet, you will get a tunnel vision effect, as shown to the right.

Falcon 4.0, however, does not simply model this blackout effect in direct proportion to the G force on the jet. If you pull 6 Gs, you will not automatically get the 6 G blackout loss of vision. Instead



Falcon 4.0 uses a model developed by the Air Force to trigger the G force tunnel effect. This model was built using actual test data to model the effect of Gs on the pilot.

Once the “tunnel vision” effect goes away, the G effect is reset back to the beginning. In other words, we only model pilot fatigue while the G effect is being displayed on your screen.

Another effect that exists in the simulation but is rarely seen is the redout effect. This effect is caused by pulling negative Gs. If you push forward on the stick long enough, you will create enough negative Gs to trigger the tunnel vision—but this time it will be colored red. Positive G force causes blackouts. During a blackout, blood is drained from your eyeballs, causing a loss of vision. Negative G force causes redouts. During a redout, too much blood is being squeezed into your cranium, causing your eyeballs to fill with blood and restricting your vision. I will add to this lovely thought that redouts are extremely rare. There is no tactical reason to push forward on the stick and pull negative Gs for a long duration. Even though the redout effect is triggered by a much lower G intensity than blackouts, you should seldom see a redout in *Falcon 4.0*.



MANEUVERING THE JET

Now that we're all up to speed on basic aerodynamics, it's time to discuss maneuvering in terms even a fighter pilot can understand. When it comes to maneuvering an aircraft, there are only three things you can do: *roll*, *turn* and *accelerate/decelerate*. *Rolling* is the act of positioning the wings which, in turn, position your *lift vector* (more on lift vector positioning later). *Turning* is nothing more than changing your flight path through sky with the application of “G.” The more Gs you command by pulling back on the stick, the faster you turn. *Accelerating or decelerating* is changing the speed of the aircraft. It can be accomplished in several ways, including thrust (throttle setting), drag and aircraft nose position in relation to the earth (weight).

The figure below shows the aircraft's lift vector coming straight up out of the top of the plane. This lift vector is produced by aircraft G and is controlled by the pilot. When the pilot pulls back on the control stick, he or she is commanding more G and a bigger lift vector. Since the aircraft moves in the direction of this vector, the more G the faster the turn. Or said another way, the higher the turn rate.

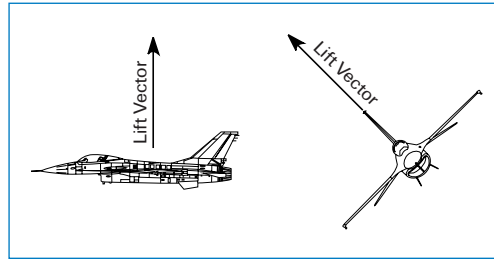

The figure below shows a very important lift vector concept. In this figure, you can see how many Gs (or the size of the lift vector) required to maintain level flight at specific aircraft bank angles. At higher bank angles, you need more Gs to keep the jet in level flight. For example, if you were at 60° of bank and only pulling 1 G instead of 2 Gs, the aircraft would descend. If you pulled more than 2 Gs at 60°, the aircraft will climb.

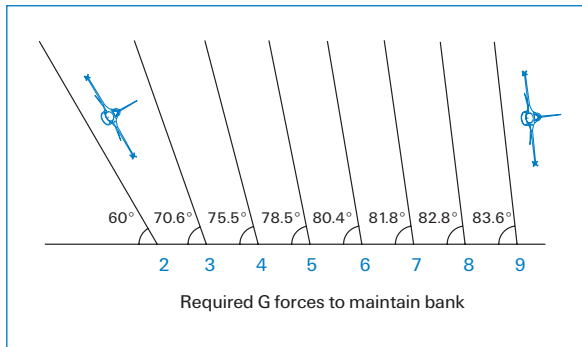

STALLS

A stall is defined as the reduction in aircraft lift caused by an aircraft exceeding its critical AOA (Angle of Attack). To understand stalls, you must first understand AOA, which is the angle formed by the body of the aircraft and its flight path.

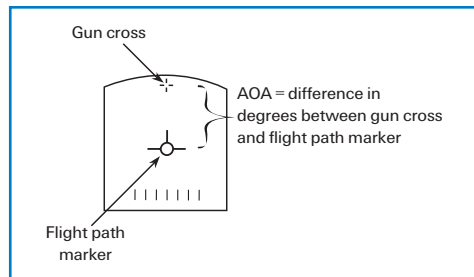



The fuselage reference line is a line that extends straight out of the body of the aircraft. This line is also the path that the bullets take out of the gun. The gun cross in the HUD shows the path of the bullets along with the fuselage reference line.

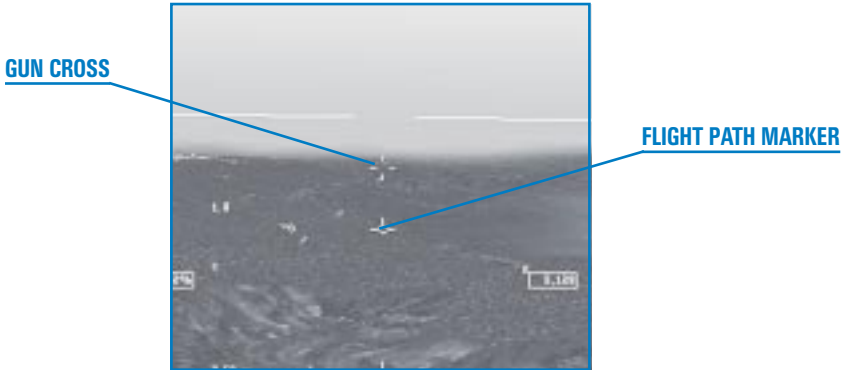

The difference between that gun cross and the flight path marker is the AOA. (These concepts are discussed in **Chapter 1: Learning How to Fly**.) Just remember that AOA is related to lift. As AOA goes up, so does lift. As the jet slows down, the pilot must raise the AOA to stay in level flight. The reason for this is that total lift produced must be equal to weight in order to maintain level flight. Since lift is directly proportional to AOA and airspeed, as you slow down you will lose lift if you do not raise the AOA of the aircraft. With the increase in AOA, lift will also increase until the critical AOA of the aircraft is reached. At this point, lift will stop increasing and will actually level off or decrease. This point in the AOA curve is called the stall AOA and is depicted in the figure below.

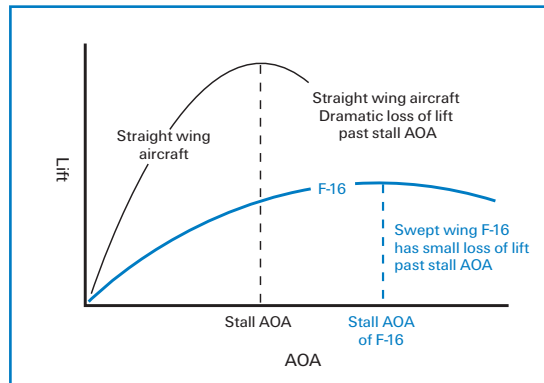

As you increase AOA on the horizontal axis of the graph, the coefficient of lift on the vertical axis goes up. (For our discussion, think of the coefficient of lift as just lift.) As AOA increases past the stall point, lift decreases. The word “stall” brings up images of the nose of the aircraft going straight down and the jet falling out of the sky. Fortunately, F-16s do not stall that way. When an F-16 flies past the stall AOA, the jet will stay in the same attitude (nose position relative to the earth) and start to slowly lose altitude. It will not fall rapidly toward the earth and the nose of the jet will not drop. To get out of a stall, all you have to do is increase power. Because of the high thrust-to-weight ratio, the jet will normally accelerate at this point and the AOA will decrease. For more on stalls, see Training Mission 7 in **Chapter 2: Learning to Turn**.

PART 4: **ADVANCED TACTICS**

CHAPTER 26: ENEMY TACTICS

CHAPTER 27: MISSION PLANNING AND EXECUTION

CHAPTER

26



ENEMY TACTICS

Falcon 4.0 features a sophisticated enemy IADS (Integrated Air Defense System). This threat system has many layers that start with C3 (Command, Control and Communication) at the top and end with individual threat systems. In this chapter, we will cover the tactics of the individual threat systems, such as SAMs and MiGs, but first we will take a top-level look at the IADS architecture.

Falcon 4.0's IADS architecture has the following key attributes:

- ✦ Connectivity
- ✦ Synchronization
- ✦ Redundancy

CONNECTIVITY

Connectivity simply means that the threat systems share information in an organized way.

Threat systems are connected via a Command, Control and Communication net, which is essentially an information grid with various types of threat systems making up the nodes of the grid. Some of these threat systems are active detection systems that probe the skies with radar. Two examples of these are the Mainstay (an enemy AWACS) and the Barlock ground-based radar. The primary purpose of these systems, called acquisition radars, is to find enemy targets and pass the information on to the Command element. Another type of system on the net are the ground-based "shooters,"

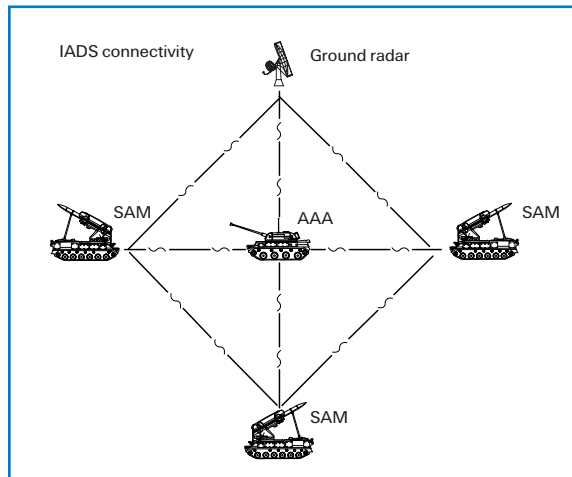

which can be either AAA (Anti-Aircraft Artillery) or SAM (Surface-to-Air Missile) systems. Some of these systems have their own radars, whereas others use passive systems to find targets. An example of a shooter with a radar is the SA-6, which can search for targets without help from the C3 net. An example of a system without a radar is the SA-9, which is an IR-guided (Infrared-guided) SAM system that searches optically for targets. Systems such as the SA-9 can be tied to the C3 net or can be autonomous. The principle of threat connectivity means that if a system such as a radar-equipped SA-6 or a non-radar SA-9 on the C3 net detects an inbound aircraft, it will pass that information on to Command net. This information can then be used to direct other parts of the IADS to engage the target.



SYNCHRONIZATION

Synchronization is the coordination of threat systems to accomplish the mission. Their mission, of course, is to defend their airspace.

The IADS will not employ all enemy systems as soon as a single flight penetrates its airspace. Instead, the enemy IADS will use the Command feature of its C3 net to direct only specific resources to engage the target. Imagine your Falcon flight penetrating the enemy IADS and being detected by a Mainstay aircraft on patrol 100 miles back from the FLOT (Forward Line of Troops). The Mainstay tries to direct fighters to the target but has no fighters in range for an intercept. Because the Mainstay can't deal with the problem, it passes the radar track to the appropriate air defense sector, which uses a Long-Track acquisition radar to pick up the target. The Long-Track is on the same C3 net as an SA-2 that can shoot at the target. The SA-2 now knows your flight's speed, altitude and direction, so it keeps its Fan Song tracking radar off until you're in range and it can take a good shot at you. This is a simple example of how the enemy IADS synchronizes, or coordinates, an attack.

Another simple example of synchronization is the use of SAMs and AAA together. Some SAMs, such as the SA-2, are only effective against medium- and high-altitude targets. For this reason, the enemy may place AAA sites and Manpads (Man Portable SAMs) at low altitude in key locations in the SA-2 envelope to pick off enemy aircraft that are descending to low altitude to avoid SA-2s.

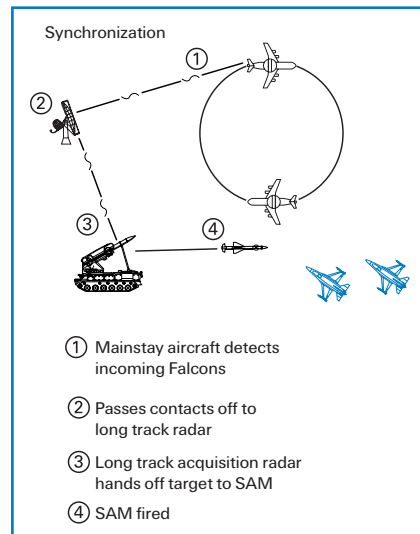

REDUNDANCY

Redundancy is the principle of having multiple systems covering the same area. The enemy IADS creates redundancy in several ways, such as by having different types of threat systems overlap the same geographic area. An example of this is the use of both SAMs and AAA around an airfield. Another application of the principle of redundancy is to overlap coverage by similar or identical systems. Several SA-6s, for example, may be positioned close together near the FLOT. The use of redundancy increases the overall lethality of the IADS and makes your job a lot tougher because your successful defensive reaction to one threat may drive you right into another one.

SAM TACTICS

Falcon 4.0's IADS features a wide variety of SAMs. This section covers some basic SAM tactics that you will face in the air battle.

Ambush tactics

(A) SAMs are silent



(B) SAMs all fire

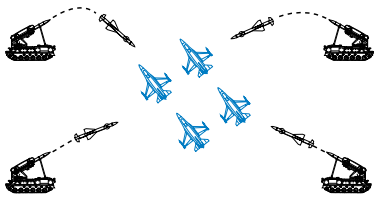

SAMs employ two basic guidance techniques: radar and IR. Since IR SAMs rarely use radar, you may get little or no warning from an IR missile launch. IR missiles are generally smaller and have shorter ranges than radar SAMs and so tend to be more autonomous and not as tightly controlled by enemy C3. Expect to see IR SAMs near concentrations of enemy ground forces, especially maneuvering armor units. IR SAMs usually find your jet visually and therefore may not fire as you pass at low altitude and high speed because they did not spot you in time. If you make multiple passes over enemy armor units or fly slowly, however, IR SAMs will probably engage you.

The radar SAMs in *Falcon 4.0* are well coordinated and will respond to penetrating aircraft using a variety of tactics. The following are a few of the standard SAM tactics used by the IADS: Ambush, Blinking and Buddy Launch.

Ambush, as the name implies, is a method used to surprise an ingressing package of aircraft. During an ambush, the SAMs hold their fire until the penetrating aircraft reach a specified distance inside enemy lines. At this point, all the SAMs bring up their radars and fire. In order for this tactic to be successful, the SAMs must use the Connectivity feature of the IADS to track the targets without using their radars. This tactic is effective because it masks the presence of radar SAMs until the last possible instant, making them less vulnerable to HARM attack.

Blinking is another SAM tactic used primarily to defeat HARM shooters. Again, this technique relies heavily on the connectivity of the IADS. During this SAM tactic, each SAM turns its radar on and off at predetermined intervals. This “blinking” is done in coordination with at least one other SAM in the area. Blinking is used primarily to confuse the attackers and defeat any HARMs that might be launched.

Blinking

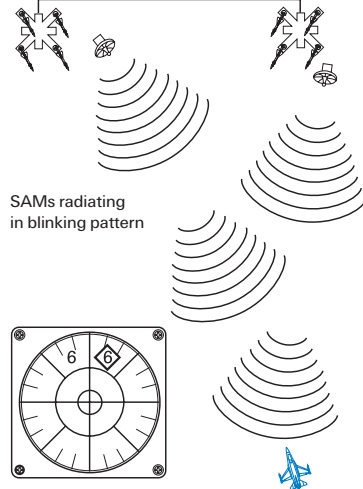

SAMs radiating in blinking pattern

Sites blinking sequence so you get alternating threat audio from each site

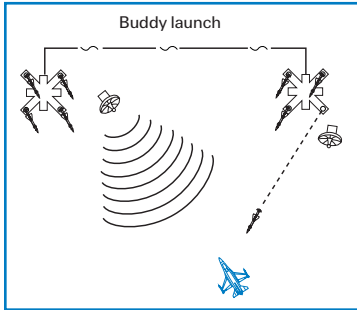

Buddy launching is similar to blinking, except that a SAM tracks the target continuously and feeds the information to one or more SAMs that will actually fire at the target aircraft. This tactic draws the attention of the targeted aircraft toward the SAM site that is not going to launch. The SAM sites that do fire can stay quiet (with their radars off) right up until the time that they put their missiles in the air. The buddy launch has two primary advantages. First, it will draw HARM launches away from the real threats and second, it will give the targeted aircraft very little warning.

SAMs are deadly and smart. They are an integral part of a coordinated air defense network and are not just stand-alone threats. To defeat the SAM component of the IADS, you must understand their tactics and be aware that you are not safe just because you don't see a SAM on your threat warning scope.

AAA TACTICS

AAA guns use two types of tactics: barrage fire and aimed fire. Barrage fire consists of shooting AAA guns into a fixed volume of airspace in the likely path of attacking aircraft. Barrage fire is usually tied into the IADS. The AAA battery knows that targets are inbound and starts firing at a set range to fill the "shoot box" full of shrapnel.

Aimed fire consists of tracking and shooting at a specific target. The AAA battery can use either radar or visual means to track the target. Visual aimed fire is more autonomous and not tied into the IADS system, while radar-guided aimed fire is usually tied into the IADS.

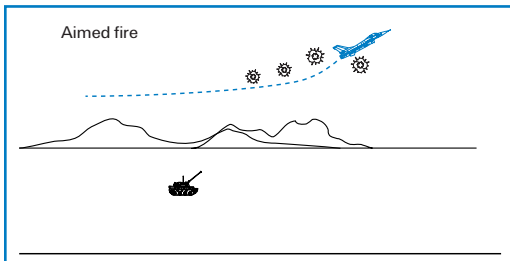
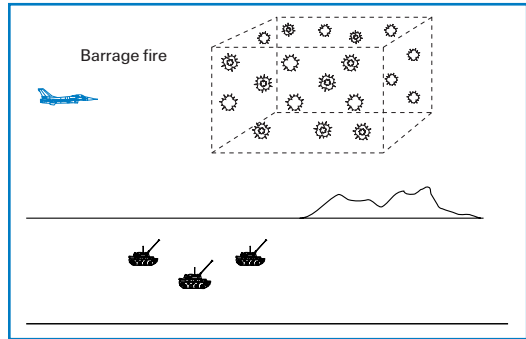

Aimed AAA is most effective when the target is traveling below 500 knots and is between 500 and 10,000 feet AGL (Above Ground Level). AAA can still engage and kill targets outside of these parameters, but the Pk (Probability of Kill) is substantially less. Above 20,000 feet, the Pk of AAA is almost zero.

ENEMY FIGHTER TACTICS

Enemy fighters are the most deadly component of the enemy IADS. Fighters have all the lethality of a SAM site but possess a mobility that makes them hard to detect and harder still to defeat. The enemy aircraft in *Falcon 4.0* will use a wide variety of tactics that are driven by three major variables: aircraft type, weapons load and range from the target. Each enemy fighter has unique strengths and will strive to fight on its own terms to maximize these strengths. For example, a MiG-19 will try to get in close and engage an F-16 in a one-circle, turning fight, while a MiG-25 will strive to stay very high and fast and shoot BVR (Beyond Visual Range) into enemy formations.

MISSIONS

Enemy fighters must taxi and take off from airbases. In other words, they will not just appear in the air in response to player action. For this reason, you can encounter enemy fighters in any phase of flight, from takeoff to landing. Because the *Falcon 4.0* campaign is dynamic, you can also be in any one of these phases when you encounter enemy fighters.

The basic missions that enemy fighters perform are:

- ✦ Escort
- ✦ CAP (Combat Air Patrol)
- ✦ Sweep

The escort mission is designed to protect other aircraft. During an escort, fighters are assigned to stay with a group of strike aircraft as they penetrate enemy airspace and drop bombs.

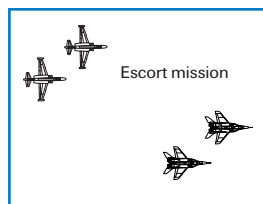

Fighters will stay tied to the aircraft they are protecting until opposing aircraft come within a predetermined "commit range," which is a certain distance from the strike aircraft. This range is usually between 10–20 miles. When enemy aircraft reach that range, the escort fighters will "strip" or leave their strike aircraft and engage the attackers.

A CAP mission protects something or someone. Enemy fighters fly CAP missions to keep you from shooting down high-value assets such as the Mainstay AWACS or from attacking ground troops. CAP missions are generally assigned to geographic areas.

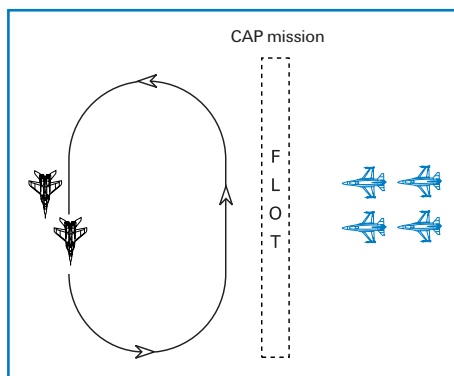

CAP missions also use a commit range to engage enemy aircraft. This commit range is generally between 10–20 miles, similar to escort missions. When an enemy aircraft is detected within the BVR commit range, the fighters leave the CAP and



engage the enemy. There is one slight variation to the CAP mission called the Ambush CAP, a tactic used by older, less-capable aircraft such MiG-19s and MiG-21s. On occasion, these aircraft will set up a CAP behind a mountain, down at low altitude. This position masks them from both AWACS and fighter radars.

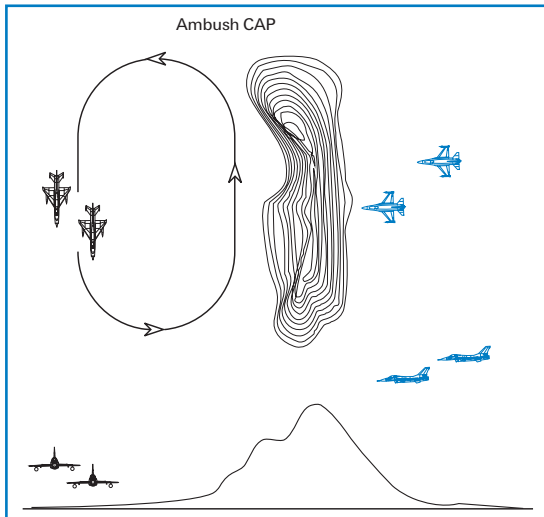

The resulting engagements usually start at very close range when an enemy fighter crosses the mountain and suddenly blunders into the CAP. This tactic negates the F-16's superior technology and speed.

A sweep mission is a pure air-to-air mission used to "sweep" or clear opposing fighters from the sky. In a sweep, enemy fighters do not have to close in and fight unless they have the advantage. You will sometimes see enemy fighters launching long-range missiles and leaving the fight when flying sweep missions. The MiG-25 often flies sweep missions in *Falcon 4.0*, but all enemy fighters are capable of performing sweep missions.

The key feature of sweep missions is that the combatants are not tied to protecting something or someone. Because of this, sweep missions have maximum flexibility, and fighters flying sweeps should only engage in turning fights if they have a distinct advantage.

BVR TACTICS

BVR (Beyond Visual Range) tactics can also be called intercept tactics. The intercept or BVR phase of the fight is the maneuvering conducted outside of visual range. The BVR area is generally beyond 10 miles. Enemy fighters in the *Falcon 4.0* IADS will employ the following BVR tactics:

- ✦ Single side offset
- ✦ Beam
- ✦ Bracket
- ✦ Drag
- ✦ Trail

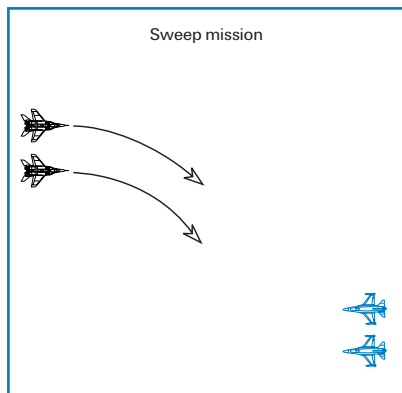

Single side offset

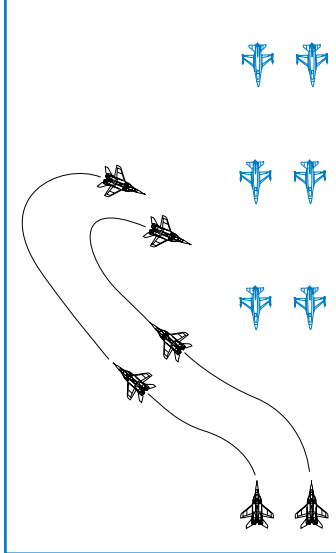

SINGLE SIDE OFFSET

In the single side offset, one or more enemy fighters will try to offset the target to one side and then swing around to the target's 6 o'clock position. This does not mean that enemy fighters flying a single side offset will wait to shoot until they get to the target's 6 o'clock position. Enemy fighters can fire long-range missiles at any time during the intercept.

BRACKET

A bracket is two single side offsets being flown in a mirror image. A bracket places fighters on both sides of the target.

This tactic is very effective because it sandwiches the target. If the target turns to engage one arm of the bracket, the other arm has an easy 6 o'clock entry. The bracket gives the target two choices—both of them bad. Either way the target turns, it winds up with an enemy at 6 o'clock. Again, the bracketing fighters can take missile shots at any time during the intercept. One variation of the bracket is the "champagne." The champagne is essentially a bracket intercept with a third fighter or group of fighters trailing the bracket.

Bracket

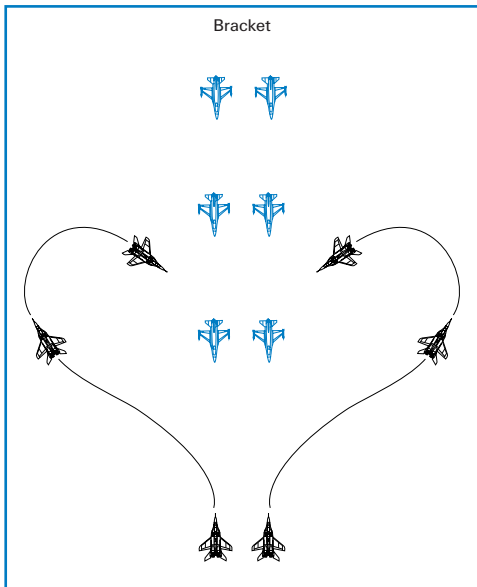



The champagne gets its name because if you look at an overhead view of the tactic, it looks like a champagne glass. OK, maybe it doesn't, but it's a cool name anyway. The champagne is used to place three fighters or groups of fighters on the target from three different attack axes.

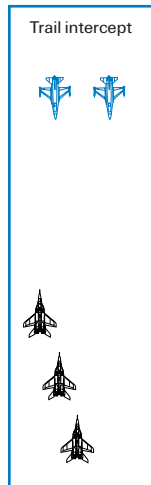

A trail intercept consists of putting aircraft at various ranges in trail with one another. These aircraft can then run straight at the target, or perform a single side offset or bracket. This tactic is effective if one side has a large number of fighters, because it makes it very hard for the opposing fighters to deal with the depth of the enemy formations. In other words, as you deal with the first fighter or group of fighters, the next group in trail is targeting your aircraft.

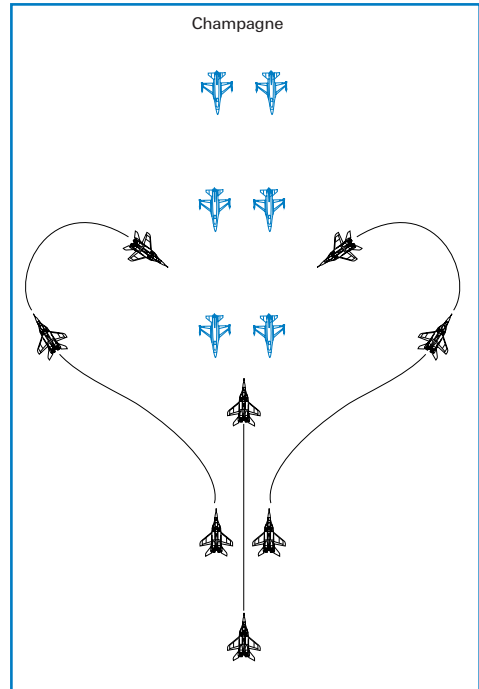

A variation of the trail intercept is the ladder. In this tactic, three or more fighters or groups of fighters are separated in range and altitude. The ladder has the same effect as a simple trail, but the stacking makes it harder for opposing fighters to detect the trailing aircraft on radar.

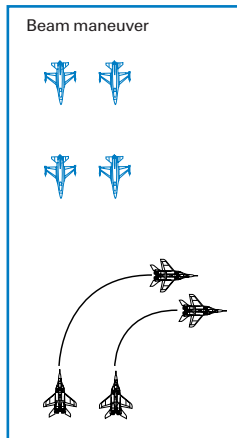
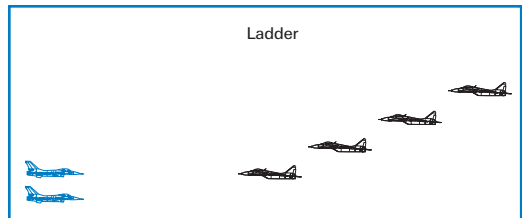

Beaming, or "turning to the beam," is a defensive intercept tactic. This maneuver consists of a turn of 90° to place the opposing fighter on the "beam." This maneuver is used to defeat a radar missile shot or to break the lock of a Doppler radar. Since Doppler radars have a difficult time tracking targets that are beaming, the maneuver is very effective against radars such as the APG-68 in the F-16.

Another defensive maneuver used by enemy aircraft is the drag, which is a 180° turn away from the opposing fighter. A drag will not defeat the opposing fighter's radar, but it may defeat a missile shot. The drag can also be used by enemy fighters to confuse you. For example, one arm of a bracket may drag so you drop that target and target the opposite arm

of the bracket. As soon as you drop lock on the dragging aircraft, the enemy fighter can turn back toward the fight and re-engage you.

All of these BVR tactics can be used together. Enemy fighters will seldom drive straight into your missiles. In the *Falcon 4.0* air battle, expect to see drags and beams when you lock your radar onto an enemy formation.

DOGFIGHT TACTICS

Enemy fighters use a wide range of offensive, defensive and head-on maneuvers in visual fights. When maneuvering one-on-one, enemy fighters will employ the best BFM (Basic Fighter Maneuvers) possible based on their aircraft types and weapons. One-on-one maneuvering is very straightforward. Enemy fighters will use both horizontal and vertical maneuvering to get you into their WEZ (Weapon Engagement Zone) as quickly as possible and will then shoot. Most of the time, however, enemy fighters fight in groups or flights of two or more.

The primary air combat tactic used by multiple enemy fighters is split-plane maneuvering. Split plane maneuvering involves two or more fighters flying in different planes of motion relative to an opposing fighter. For example, if you are turning level with the horizon defending against one MiG-29, the other MiG-29 will maneuver in the vertical above you.

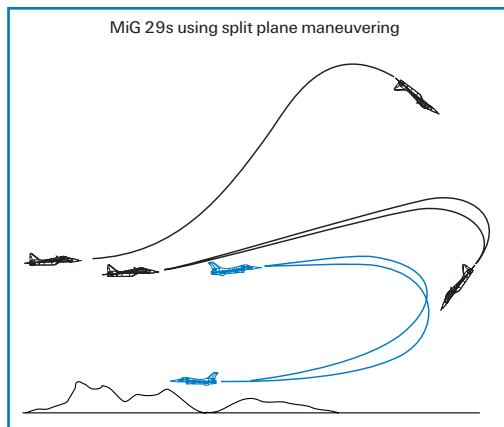
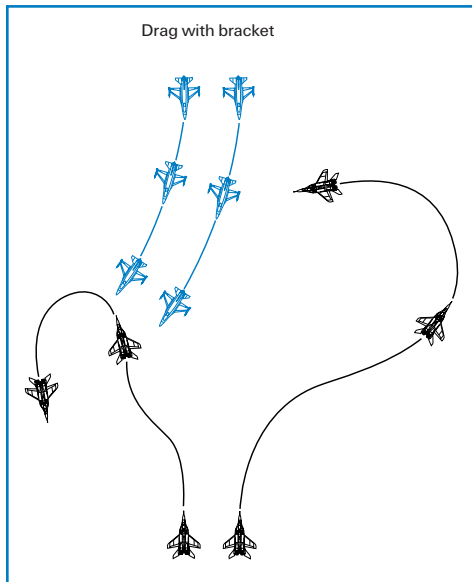

A fighter can only maneuver effectively against one jet at a time. Enemy aircraft take advantage of this fact by maneuvering in different planes of motion when fighting a single target. For example, in the figure, the F-16's defensive turn is only effective against the in-plane MiG-29. The MiG above the fight is unaffected by this turn and can eventually gain an easy entry into the fight.

Be very careful flying alone. Multiple enemy fighters will maneuver in different vertical planes and make it very difficult for you to survive a sustained turning fight.

CHAPTER

27



MISSION PLANNING AND EXECUTION

The principles explained in this chapter apply to all *Falcon 4.0* (and real F-16) missions. This chapter will cover planning and flying a typical single mission in the campaign, not campaign strategy.

GENERAL MISSION PLANNING

BY PETE "BOOMER" BONANNI

A successful mission starts in the planning phase. For this sample mission, I have selected an OCA Strike mission against an airbase in the Iron Fortress campaign. The purpose of OCA (Offensive Counter Air) is to gain air superiority. There are two types of OCA missions: air-to-ground against airfields (OCA Strike) and air-to-air flown to sweep enemy aircraft from the skies (OCA Sweep). Remember that what I will describe in this chapter is just an example. Your mission, of course, will be different because the dynamic campaign in *Falcon 4.0* ensures that no two missions are ever alike. You should be able to follow along, though, by selecting a similar OCA mission.

- ✦ Select Campaign from the main menu and then press the Commit button in the lower right-hand corner to continue.
- ✦ Next, look at the Mission Schedule.
- ✦ Select an OCA mission from your squadron's Frag Order list.
- ✦ The first step in the planning process is to select the Briefing icon and read the Mission Brief.
- ✦ On the Briefing screen, learn what your targets are. Look for these targets under the heading "Intelligence reports the highest impact targets." We'll discuss targets later.

**MISSION
SCHEDULE**

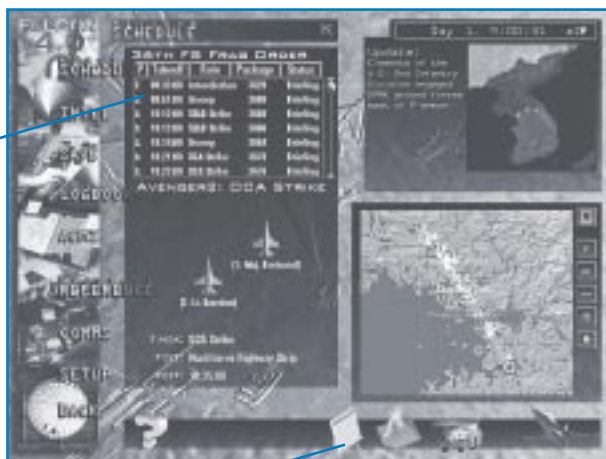

BRIEFING ICON



Before continuing, I'd better explain a modern air combat tactic called "packaging." Packaging is a real-world fighter tactic that groups several flights together to perform a specific task. This means that in a campaign mission, your flight will often be one of a number of flights in a specific group of aircraft. In your package, you may have air-to-air or SEAD (Suppression of Enemy Air Defenses) support, as well other flights also bombing your target or one close by. Furthermore, these flights can consist of a mix of all types of aircraft. The key advantages of packaging are massed firepower and cooperative protection.

The next step is to fill out your lineup card. When you fill out the lineup card, you review your package and other pertinent information about your sortie. In addition, you will create a tool that you can use in flight.

- ✦ You must start with a blank lineup card. Either photocopy the one in **Appendix D: Lineup Card** or print out the file on the *Falcon 4.0* CD-ROM. We have provided the lineup card in both Microsoft Word (F4LINEUP.DOC) and Adobe Acrobat (F4LINEUP.PDF) file formats.

The lineup card in *Falcon 4.0* is patterned after the real ones used in the F-16. An example of a filled out lineup card is shown in **Appendix D**. To fill out the card, you need to use both the Briefing view and the Mission Planner. Using the Flight Planner, step through all the flights in your package and write down their TOT (Time Over Target).

- ✦ Click the Flight Plan icon to open a window labeled with your package number.
- ✦ Click the down arrow next to the word "Flight" of the Flight Planner. A list of all the flights in your package appears and their routes are displayed on the planning map. As you call up each flight, step through the steerpoints until you get to TGT (Target) and then write down the TOS (Time Over Steerpoint). Remember that when the steerpoint is the target, TOS becomes TOT (Time Over Target), which is the time that the flight plans to arrive over the target. Flight members in your package may all have slightly different TOTs, but they all fly the same route to the target. The exception to this rule is that flights in your package coming from other airfields or an aircraft carrier will have a different takeoff point and route to the push point (also known as the marshal point).

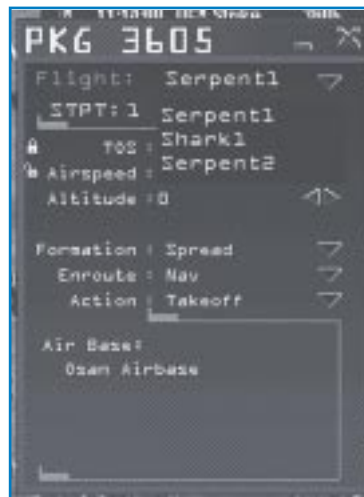

CHANGING YOUR FLIGHT PLAN

The planning map is a powerful tool for changing your mission parameters. Before we talk about changing your route, let's talk about what the Campaign mission planner does for you. The Campaign mission planner strives to provide a flight route that will minimize the package's exposure to known threats. This route consists of steerpoints, airspeeds, altitudes and timing.

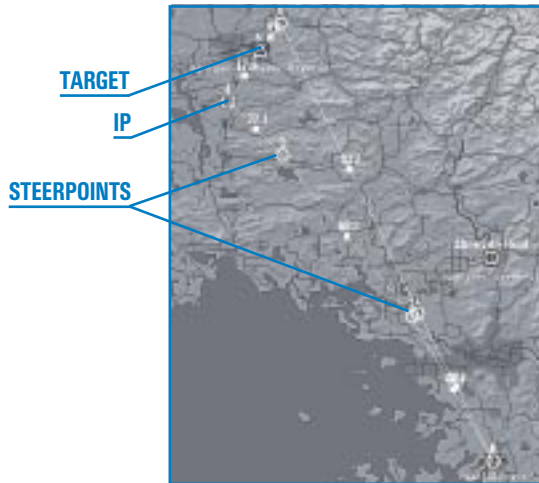

The basic parts of the route are the takeoff point (an airfield or aircraft carrier), a push or marshal point, the route segments, the IP (Initial Point) and finally the target. The screen shot to the right shows a route with these points labeled. A triangle represents the target, while a square shows the position of the IP. All the rest of the steerpoints are circles.

You can, of course, enter the Flight Planner and change any of these parameters. There is no right way to make changes to your route, but there are techniques that make it less confusing. You can easily change the route displayed on the Planning Map. It is a simple drag-and-drop operation. That's the good news. The bad news is that you have to be aware of the relationship between TOS and airspeed when you start tinkering with the route.



- ✦ The first step is to expand the Planning Map by clicking on the Maximize button in the top right corner.



- ✦ Place the mouse over a steerpoint you want to move. When the cursor changes from  to , click to display the Flight Planner.
- ✦ Keep the circular arrow icon over the steerpoint and you can now drag the steerpoint to a new location on the Map.

Notice that when you drag the steerpoint, either the airspeed parameter *or* the TOS will change. Any time you move a steerpoint, either the time or the airspeed has to change. It's like when grandma moves to a house further away. When you travel to see her this year for Thanksgiving, it will either take you more time to get there or you will have to drive faster if you want to get there at the same time. One or the other parameter has to change: time or speed. Notice also that the Flight Planner has a small padlock icon next to both TOS and airspeed. When the padlock icon is locked, it means that the parameter next to it is locked.

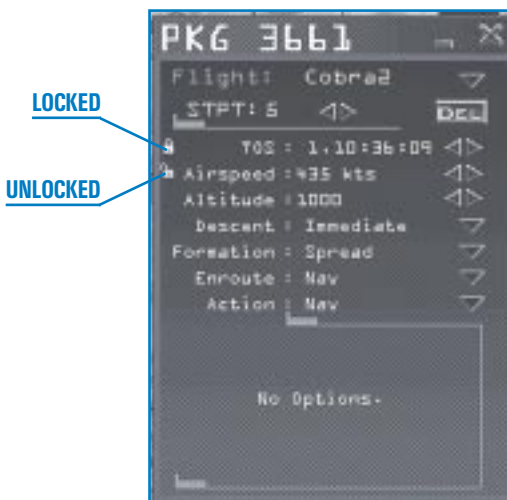

Before going any further, we should discuss the Flight Planner defaults. In the Campaign, you *cannot* change your takeoff time for a specific mission. The Flight Planner also defaults to a locked state for TOS at the push point (usually Steerpoint 2) and the target ("TGT"). To review: you have a *hard* (unchangeable) takeoff time; times for the push point and target can be changed but are locked when you enter the Flight Planner.

What does all this mean? The Campaign mission planner is simply trying to keep you from messing up the package when you start moving steerpoints around. To change a locked parameter, unlock that

parameter by clicking on the padlock icon and lock the airspeed. Now if you move the steerpoint, the time (TOS) will change.

Let's say you decide to lock airspeed. If you grab a steerpoint and move it 7 miles farther with a locked airspeed of 420 knots, your TOS will be 1 minute later (because at 420 knots, you are going 7 miles a minute). You don't have to know the formulas because the Flight Planner will automatically make all the calculations for you. All you have to do is decide if you want to change the airspeed or the time.

If you drag a steerpoint too far, however, the Flight Planner may calculate that it cannot be flown because the route speed is now too fast or too slow. In this case, the Flight Planner will color the route segment red.

When you change the route for your flight, you change only your specific flight. If your goal is to keep the package together, you must step through each flight and make identical changes to all of their routes. Now you know how to change your route, but you may still be wondering why you should change the position of your steerpoints. The two main reasons for changing your steerpoints are to avoid threats and to alter your attack on the target.

ADJUSTING PACKAGE SPACING

Adjusting the spacing of the flights in your package is an important mission planning skill. To adjust the flow of flights into the target area, you must adjust the TOT (TOS at the target) of all the flights in the package. This section will cover some tactical rules of thumb for making package spacing adjustments and how to do it with the Flight Planner.

The first step is to look at the TOTs for all of the flights in your package. Don't forget that it is easier if you write them all down on your lineup card. The flight members for this sample mission are listed in the table below. Remember, your mission will be different because no two *Falcon 4.0* campaign missions are ever the same.

Callsign	Mission	Original Time	New Time
Cowboy 1	OCA Strike	1027:27	1028:27
Falcon 1	OCA Strike	1027:37	1028:57
Fury 1	SEAD Escort	1027:45	1027:27
Vapor 1	BDA Recon	1028:27	1030:57

This table shows the computer-selected TOTs for all the flights in this package under the column "Original Time." The changes that I made to the package TOTs are under "New Time."

Here are some planning considerations when making timing changes to your package. I personally like to have different flights spaced at least 30 seconds apart in the target area. The exceptions to this rule are the escort flights that might be assigned to the package. If you have SEAD escort or air-to-air flights in the package, it is a good idea to put them out in front of the package. To accomplish this, I would give the escort fighters a TOT of 1 to 2 minutes ahead of the first bombers on the target. At combat speeds of around 480 knots, 1 to 2 minute spacing puts the escort flights 8–16 miles out in front of the first bombers on the target. When I do flight planning, I usually use a fixed airspeed of 480 knots. This airspeed is going to be very close to the actual combat airspeed that I am flying. At 480 knots, you are traveling 8 miles per minute. If you are planning to use a different airspeed, you can figure that each increment of 60 knots of airspeed is approximately 1 nm per minute. At 420 knots, for example, you are traveling 6 miles per minute.



In the example, I have two flights dropping bombs (Cowboy 1 and Falcon 1), one flight on SEAD escort (Fury 1) and one flight doing battle damage assessment (Vapor 1). I would leave my SEAD escort (Fury flight) at the 1027:27 TOT, but move Cowboy (a bomber) 1 minute back to 1028:27. The Falcon flight should be 30 seconds behind Cowboy (1028:57). Thirty seconds equates to about 4 miles of spacing. The BDA (Battle Damage Assessment) reconnaissance flight should be at least 2 minutes behind the bombers (1030:57) to give the smoke and debris from the bombers time to settle. Along with changing the TOTs, you need to change the times of all of their steerpoints as well. This will ensure that you have a smooth flow into and out of the target. The new order of ingress into the target is:

Callsign	TOT	Spacing From Flight in Front
Fury 1	1027:27	—
Cowboy 1	1028:27	8–16 nm from Fury (1–2 minutes)
Falcon 1 (our flight)	1028:57	4 nm from Cowboy (30 seconds)
Vapor 1	1030:57	4 nm from Falcon (30 seconds)

By re-flowing (changing the timing) the flights in the package, you will now have the SEAD escort fly into the target area first.

Keep in mind, however, that you do not have to modify the plan provided for you by the Campaign mission planner. If you don't want to spend the time, just jump in and fly it as is. If you skip this step, however, at least look at the following items:

- ✦ Note the mission types of the other flights in your package. It is important to know if you have dedicated SEAD escort or air-to-air escort.
- ✦ Look at the weapons that are loaded on the aircraft in your package. You cannot change these weapons, but it is important to know how other members of your package are armed. If, for example, the other F-16s in your package are armed with AIM-120s, then you know that you will have good capabilities against enemy aircraft.

TARGET PLANNING

The next step in this process is to plan your attack. All planning starts at the target. Use the expanded Planning Map to bring up the route of flight.

Remember that the circles are the steerpoints or turn points along your route. The blue square is the IP, which is where we start to get serious about sending somebody to the meat locker. The next route symbol is a blue triangle overlaid on the target itself. In this mission planning phase, we are going to take a close look at the target.

- ✦ Right-click on the target icon to bring up the menu seen below.

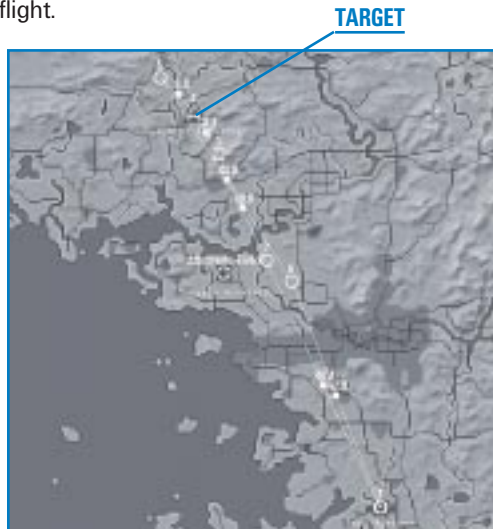
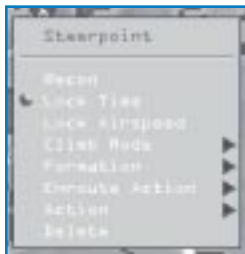

- ✦ Select the Recon menu option. This will bring up a screen with two windows. The top window is a recon view of the target area. This recon view will include the target along with some view controls. The bottom window is a list of all the targets in the area.





- ✦ Use the top button to change the viewing angle. Click the next control to rotate the view to any heading. Zoom in and out with the arrow icons. The bottom of the Recon window lists the slant range to the target from the view that is showing. Using these view controls, you can get an idea of what your target will look like during an attack.

Attack planning should consist of the following steps:

- ✦ Study the target from a specific attack heading. Let's say, in this example, we are dropping BLU-107s. Since these weapons crater runways, we need an attack axis that takes us straight down the runway. To review weapon characteristics, click on Tactical Reference on the left-hand menu. In Tactical Reference, select Munitions, then Bombs to review the BLU-107. In the "Engagement Sequence" section of the BLU-107 description, you'll read that the bomb should be dropped from low altitude, specifically 250 feet.
- ✦ Based on this information, do some target study from 250–500 feet AGL (Above Ground Level). Use the Recon view to plan your attack axis or heading into the target.
- ✦ Once you plan an attack axis, go back to the Planning Map and move your IP so that you can make an attack on your desired heading. In this case, since I will come straight in at the target at 500 feet AGL, I want to line up the IP with the runway. The picture below shows an IP heading straight out from the runway. All IPs should be 8–15 miles from the target.

INITIAL POINT

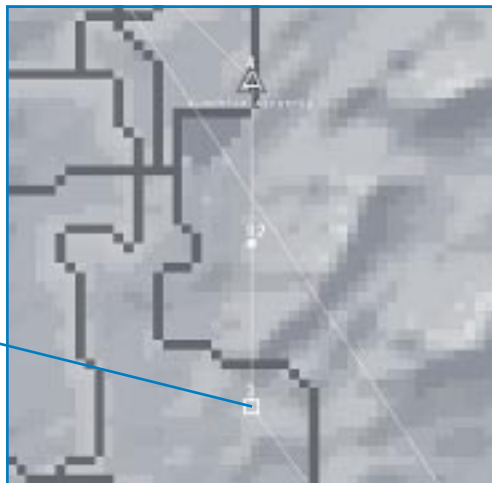

THE ENEMY

When you line up your attack axis, you should also check the threats in the target area.

- ✦ Right-click on the Planning Map to bring up the Map Options menu. From this pop-up menu, select Threat Circles. Since the weapon we are using forces us to attack from low altitude, select Radar – Low altitude from the Threat Circles submenu. The Planning Map now shows the territory covered by enemy radars that scan below 5,000 feet. Be aware that you will be detected and possibly engaged by low-altitude SAMs and AAA in these areas.



In addition to radar-guided threats, keep in mind that any time you fly over the bad guys you can be engaged by Manpads (Man Portable) SAMs such as the SA-7 and SA-14. These systems are infrared-guided. Remember that since AAA can also be aimed with the human eyeball, you may not get any warning from your threat warning system.

- ✦ To determine the position of enemy army units, select Ground Units from the Map Options menu. Then choose your desired options from the submenu. Along with the ground-based threats, you can also display air threats on the Planning Map.

Remember that when you look at threats on the Planning Map, the map uses a simulated sensor fusion model to show what our side *thinks* is happening. The aircraft positions plotted on the map are coming from an AWACS feed, and the picture may not be complete. The positions of ground and air threats are not complete and may not be accurate. This inaccurate information is sometimes referred to as the “fog of war.” Even if the picture on the Planning Map is perfectly true, it will probably change significantly by the time you get airborne. Just because it may be inaccurate, however, does not mean that it is not useful. Though intel may have some gaps, it is still better than just stooging around out there blindly.



Once you have studied the enemy and made whatever modifications to your attack plan that are necessary, it's time to get into your jet.

- ✦ Close the Planning Map by clicking the Minimize button in the upper right-hand corner.

GROUND OPERATIONS

- ✦ Start the mission by clicking the Fly icon in the bottom right corner. If you are playing in single-player mode, the clock will "fast advance" to your takeoff time. In this screen, you have the option to return to the Campaign interface, start on the taxiway in line with other jets or start on the runway for takeoff.

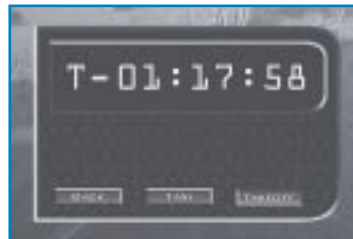

No matter which option you select, as soon as you get in the cockpit, get your MFDs set up properly. I perform the following Ground Ops steps prior to takeoff:

- ✦ Press **[F1]** until you see the radar display in the left MFD. Then select RWS (Range While Search) by pressing **[F1]** until "RWS" is displayed in the left MFD. I use the following radar options for takeoff: 20-mile range scale, 4-bar scan and $\pm 60^\circ$ azimuth scan (as shown to the right). Note that when you start the mission, the radar will normally default to RWS in the left MFD. You may, however, want to change your scan options.

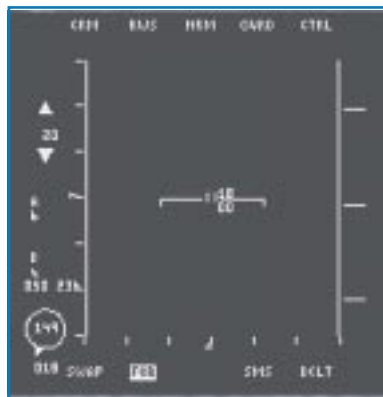

- ✦ Call up the SMS (Stores Management System) display by pressing **[F1]** until "SMS" is highlighted at the bottom of the right MFD. Next, select your primary air-to-ground weapons. In my case, I'll select BLU-107s by pressing **[Backspace]**. Now change the number of release pulses ("RP") and the interval between bombs ("25 FT"). Change the release pulse to "6" (or however many BLU-107s you have loaded) and the interval to 175 feet. The screen shot shows this weapon display.

These weapon settings will give you 6 runway craters with 175-foot spacing between them. To drop this load, you only need to push the pickle button one time. You will, however, need to *hold down* the pickle button until all the bombs drop off the jet.

- ✦ Now that your weapon is configured, bring up the HSD (Horizontal Situation Display) by pressing [J] until you see “HSD” on the MFD. Once the HSD appears, press [F11] or [F12] to change the range scale until you can see Steerpoint 2 on the display. A good rule of thumb for setting the HSD range scale is to set it so that the selected steerpoint is visible on the MFD.
- ✦ Next, reset the HUD mode back to NAV mode by pressing the NAV button on the ICP.
- ✦ When you first enter the jet, you will be at Steerpoint 1, which is the runway.

You are now ready to take off!

TAKEOFF AND CLIMBOUT

In *Falcon 4.0*, you are part of a dynamic air war. Takeoff is a critical part of any mission because every runway in Korea is being used to

launch and recover jets as quickly as possible. If you don't take off on time, you'll not only be late for your mission but you'll also plug up the runway like a cork up a pig's butt. In all missions (except in multiplayer campaigns), take off as soon as possible after being cleared by ATC (Air Traffic Control). Select the next point in the route, Steerpoint 2, by pressing [S]. Check to see that Steerpoint 2 is flashing on the HSD display. Turn your jet toward Steerpoint 2. It is important to get on a stabilized heading for your steerpoint. From this position, you can start to get a picture of the air battle.

INGRESS

- ✦ Adjust your airspeed to fly the timing caret to Steerpoint 2.
- ✦ Switch to the radio frequency for your package by pressing either COM button on your ICP to make that your active radio channel (designated by a small square on the DED). As long as the radio function knob on the left cockpit console is set to Norm, click the ICP increment and decrement arrows to change to radio channel 3, so you can both broadcast and send to your package.





On this OCA mission, Steerpoint 2 is the package push point. This is the point where all of your package flights will go to push, or fly out, toward the target. Remember that in this plan I have spaced everybody out so that we will all arrive at the target at slightly different times. For the plan to work, however, you must fly at the proper airspeed. The screen shot to the right shows the jet “flying the caret,” which means that the jet is flying at an airspeed that will allow it to arrive at the selected steerpoint on time.

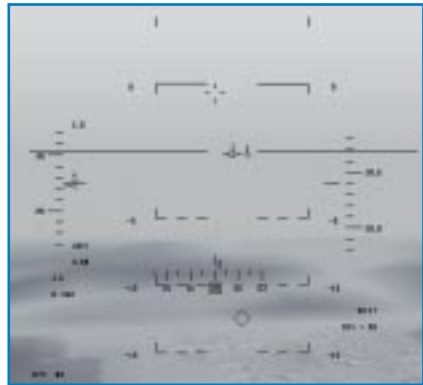

- ✦ As you approach Steerpoint 2, check the position of your package using your radar. This point is usually before the FLOT (Forward Line of Troops). In our example, you should have Fury and Cowboy in front of you. Fury is so far in front that you might not see them on radar, depending on the range scale you have selected. How do you know that radar contacts on your scope are your package? You should be able to tell because the targets will be stationary on your radar scope. Stationary targets mean that you have aircraft in front of you going in the same general direction. Bad guys will march quickly down the scope and into your chili. Helicopters will come slowly down the scope. If you are not sure who's who, lock on and check their airspeed and heading. If it is the same as yours, they are probably your guys and more times than not you'll get a “Buddy spike” call.
- ✦ Once you have detected your package on the radar, start to look for other targets. If the scope is clear (except for known friendlies), expand your search to the 40-mile range. If unknown targets are present, sample them to get a picture of the air battle. To sample a target, place your radar cursors over it to get the target's altitude. With the cursors still over the target, query AWACS to “Declare” by pressing [Q] and then [2]. If it can, AWACS will tell you if the target under your cursors is hostile, friendly or unknown.

Treat all unknowns as bad guys that you can't shoot at until you visually identify (VID) them. As a rule of thumb for air-to-ground missions, always try to avoid hostiles and unknowns until you have confirmed that they are intent on attacking you. When they spike you (lock onto you), you have to deal with them, a situation we'll discuss later.



- ✦ Check the position of the FLOT, the long line that runs across the MFD, in the HSD.

The FLOT is an area of intense ground combat. Ground combat involves a large number of soldiers with weapons and bad attitudes, so it's not a good place to hold an air show. When you get within 10 miles of the FLOT, take your attention off the radar and start focusing your attention on the FLOT. There is one exception to this rule: if you have a confirmed hostile target inside 20 miles, you must focus your attention on that target. My rule of thumb is to always focus on the most immediate threat. A known enemy fighter inside 20 miles is more of a threat than an unknown enemy ground threat along the FLOT.

My plan on this mission is to cross the FLOT at low altitude. To accomplish a FLOT crossing at low altitude, get down low (300 feet AGL) and go fast (550 knots). This will reduce your exposure in the FLOT area. It is important not to fly in a straight line for more than 3–5 seconds in the FLOT area. As you cross the FLOT, make small random turns (jinks) so that enemy AAA gunners cannot draw a bead on you.

As you approach the FLOT, you will probably see explosions and the other pyrotechnics associated with a large-scale ground war. It is best to lean away from any combat action that you see out on the horizon. This is going to be hard to, because we all tend to act like moths to a flame when it comes to things blowing up, but you will survive longer if you stay clear of these activities.

There are two more important points about FLOT crossings. The first is that the segmented line on your HSD represents your best intelligence at takeoff, and it may be inaccurate. The second is that the FLOT is *not* linear. This means that the real fighting along the line will be "lumpy," with areas of enemy advance or retreat. You must exercise extreme caution when you get within 10 miles of the FLOT.

Back when I was a young F-16 pilot—unlike the grizzled F-16 pilot I am now—I developed a way of thinking about threats. The illustration below shows how to change your focus on threats during a mission.

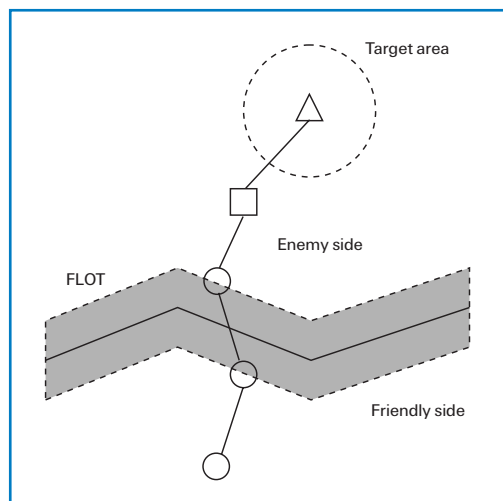



Notice that I have broken down the ingress into specific areas of concern. On the friendly side of the FLOT, enemy aircraft are your principal concern. In the FLOT area, enemy ground-to-air threats (such as AAA and SAMs) are the biggest threat. On the enemy side of the FLOT, you may have the full spectrum of threats, but most of the time your route should keep you away from SAMs and AAA. Threat aircraft are therefore your biggest concern on the enemy side. Since any target worth bombing is worth defending, the bad guys will be waiting for you when you get within 5–10 miles of the target area. In the target area, SAMs and AAA will come back to the top of the threat list. Let me add a word of caution here on dealing with threats in *Falcon 4.0* (or in a real F-16). Our model is simple, but the IADS (Integrated Air Defense System) you face is not. You may be right in the middle of doing the funky chicken with a MiG when some bozo shoots a SAM up between you. The enemy has plans and procedures for dealing with enemy aircraft, but plans rarely survive contact with the enemy. Focus on the nearest threat—but be ready for anything.

THREAT REACTION

Threat reaction can be broken down into several phases. The first phase is to keep the enemy from acquiring or finding your aircraft. In dealing with threats, I use the following techniques:

- ✦ Deny
- ✦ Delay
- ✦ Disrupt

In this mission, we are ingressing at low altitude and should be able to *deny* enemy acquisition during the first part of our ingress into the target area. On some missions, you will be able to completely deny enemy acquisition by flying low. On this mission, however, we know that we will enter enemy low-altitude radar coverage when we get close to the target. Our ingress altitude of 500 feet will *delay* enemy acquisition and thus our exposure in the target area. The first two techniques on the list are passive. *Disruption*, however, implies an overt action on our part, such as shooting at the threat or jamming it. The section below will cover specific actions you can take to deal with enemy aircraft and SAMs.

DEALING WITH ENEMY AIRCRAFT

Let's say that just as our flight enters enemy airspace, AWACS gives us a hostile declaration on targets that are 20 miles out and heading our way, as shown to the right.

At this point, I would target the other element in my flight (planes #3 and #4) on the incoming enemy threat. This would be a way of disrupting an enemy attack. To target the enemy:

- ✦ Put your radar cursors on the target.
- ✦ Press **[E]** to bring up the Element radio command menu. Select "Attack my target."
- ✦ Lean away from the target at least 30° while your other element takes on the enemy.
- ✦ As you lean away, drop chaff.

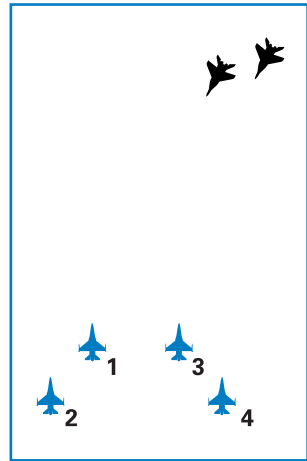

The figure below shows a diagram of the fight.

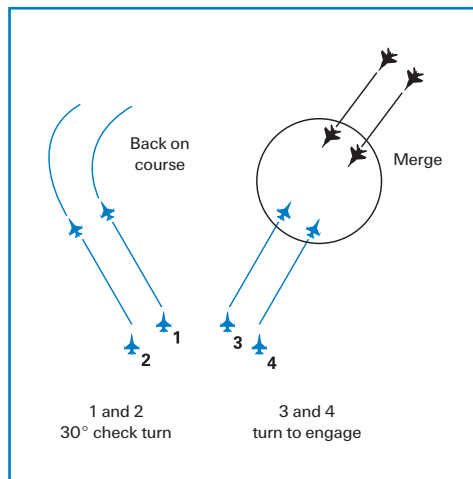



- ✦ Return to course after your element gets 10 miles away from your jet. The key here is to open some separation with your element so that they can fight the enemy while you and your #2 man fly on to the target.

Here is a list of actions to take if you are being targeted by BVR (Beyond Visual Range) enemy aircraft:

- ✦ Query AWACS to “Declare.” This will help you get AIM-120s or AIM-7s in the air as soon as possible to avoid a turning fight.
- ✦ Target your wingman’s MRMs (Medium-Range Missiles) into the target first.
- ✦ If there are multiple enemy targets, target your radar into the next enemy aircraft that is a factor.

Here is what to do if you are trying to drop bombs and are being targeted by enemy aircraft within visual range:

- ✦ Try to get a missile in the air as you enter the fight.
- ✦ Fight the most immediate threat. If nobody is behind you, the most immediate threat is the closest aircraft.
- ✦ Keep your external stores unless your airspeed gets down below 300 knots. If the bandits are driving your airspeed down below 300 knots, jettison all of your bombs and tanks.
- ✦ Look for a way to get out of the fight and back to your mission. Usually you will need to kill the bandits in the fight, but sometimes they will run out of gas or missiles and will flee. If this happens, get back to the business of dropping bombs.

DEALING WITH SAMs

You can be engaged by SAMs virtually anywhere on the battlefield. I have written extensively about specific maneuvers used to counter a missile in the air in **Chapter 7: Missile Threat Reaction**. We won’t rehash “missile in the air” techniques here, but we will discuss how to deal with SAMs in general. Radar-guided SAMs bring up their radar when they put a missile in the air. They may also bring up their radar to search for you if they do not have good command and control. Once they bring up their radar, radar-guided SAMs can be detected by your TWS scope. Ground-to-ground threat radars are called “Muds,” and air-to-air threat radars are called “Spikes.” The procedures below will help you deal with them.

- ✦ If you get a Mud on your nose approaching the FLOT, lean (turn slightly) away to avoid it or pump. A pump is simply a 180° turn. By pumping, you can get back over friendly territory and try a different route across the FLOT. If you are already in enemy territory, don't pump.
- ✦ If you can't avoid it, get lower. I never fly lower than 100 feet on the radar altimeter.
- ✦ Drop chaff by pressing [X] and turn on your jammer by pressing [J].
- ✦ Move your flight into a Spread Four formation if you are not already in one. Switch to this formation by pressing [W] until you get the Formation Management menu. Select "Go spread" to keep a threat from shooting at both the lead and trail groups in the flight. If you are in a Trail, Box or Arrowhead formation, the threats can shoot at you like ducks in a shooting gallery. If your flight is in a line-type formation such as Fluid Four or Spread Four, you will give the threat a chance to only shoot at a single target, as shown below.

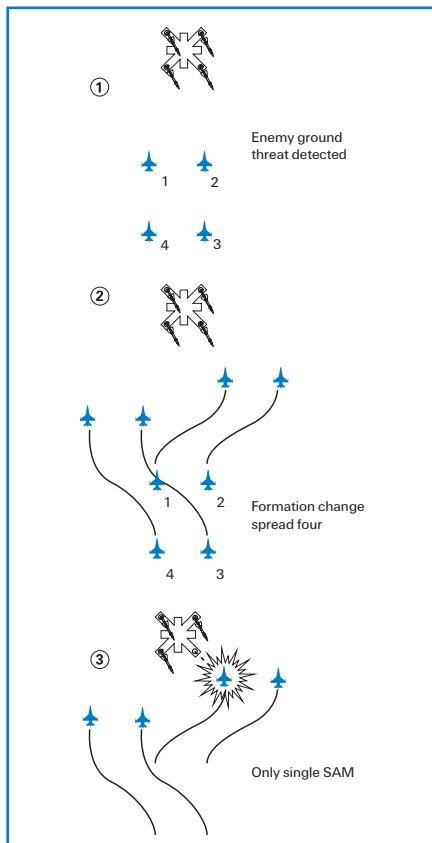



This formation is useful against all radar threats, including AAA.

If you get a SAM launched at you during the mission, you must immediately stop what you are doing and react. If your wingman gets shot at, stay with him unless you are in the FLOT area. In the FLOT, it's "everybody for their own grandma's ear." In other words, you are on your own in the FLOT area. No need to get everybody shot down by hanging around in a bad neighborhood.

DEALING WITH AAA

AAA comes in two types: aimed and barrage. These two types are very different, but your reaction should be the same. If you are under attack from AAA, use the following procedures:

- ✦ Jink by randomly changing your heading and altitude every 2–5 seconds. Change both your heading and altitude by moving your nose at least 10° degrees but not more than 45° .
- ✦ Do not turn more than 45° or you will end up flying around too long inside a AAA barrage. Remember that this technique does not require you to differentiate between barrage and aimed fire.
- ✦ Drop chaff by pressing .
- ✦ Fly faster to reduce your exposure.
- ✦ Do *not* mess around with an AAA gun. My father taught me a rule that came out of his experiences in the Vietnam War: Never attack a gun that is trying to shoot you unless it is your assigned target. You may win a few, but you will also lose a few for no good reason (besides the fun factor).

THE ATTACK PHASE

The ingress phase is over when you hit the IP, which is the start of the attack phase. At the IP, perform the following tasks:

- ✦ Switch to the CCIP mode to drop your BLU-107s on the runway. To do this, call up the SMS page in the right MFD by pressing [1]. Then press [Backspace] to cycle through your air-to-ground weapons.
- ✦ Drive in toward the target and keep cross-checking your range on the HUD. When you get to within 5 miles, start a 5° fly-up to acquire the runway and line up for your attack.



5° PITCH LINE

- ✦ When you see the runway, line up and bunt (push slightly forward on the stick) back down for a 500 foot AGL level release.
- ✦ Track the pipper straight down the runway.



- ✦ When the pipper gets one-third of the way down the runway, pickle and *hold down* the weapon release button (Spacebar or joystick button 2).

**PIPPER**

- ✦ After holding the pipper down for at least one second, roll up to 60° of bank and turn away from the target.
- ✦ Press S to continue to the next steerpoint and turn to fly toward it.

EGRESS PHASE

You are now in the last tactical phase of the mission. It is very easy to relax and let your guard down after completing a bombing run... but don't do it. You still have to get out of the badlands, You have AIM-120s loaded in this mission, so it's time to call them up and start looking for a place to put them. Yes, this is the part of the mission where I toggle off my "Please-don't-hurt-me" mind-set and think instead, "Let's get ready to rumble!"

As we egress the target area, stay aware of the basic threat areas. Again, these are the target area, the enemy side, the FLOT and the friendly side. The best place to engage MiGs is obviously on the friendly side. The next best place is on the enemy side. You definitely don't want to do a lot of turning in the target area or the FLOT. Your geographic location then changes your engagement criteria. The term "engagement criteria" refers to parameters that I am willing to accept before I start a turning fight. Any time you are spiked or in the WEZ (Weapon Engagement Zone) of an enemy air-to-air weapon, you don't have a choice—you have to turn and fight. This engagement criteria does not refer to taking BVR shots. You can always hose off the "great white hope" (the AIM-7) or an AIM-120 and see how she flies. Engagement criteria only refers to our parameters for offensive or head-on maneuvering. Again, it is best to just slip past enemy aircraft you see in high-threat areas—but if you have the gas on egress, turn and engage fighters after you complete your bombing run.

CONCLUSION

My goal in this chapter was to help Falcon pilots like you develop tools for tactical thinking and to help you learn some specific techniques for surviving in an air battle. Since I have just scratched the surface of Falcon air combat techniques, you must develop your own tactical perspective just as I have. Luckily for me (OK, it's by design), I can transfer my real-world experience directly into most parts of the game. For more tips on mission and campaign strategy, check out the official *Falcon 4.0* Web site at www.falcon4.com.

PART 5: ***APPENDICES***

APPENDIX A: DESIGNER'S NOTES

APPENDIX B: GLOSSARY

APPENDIX C: AIRPORT MAPS

APPENDIX D: LINEUP CARD

APPENDIX

A

DESIGNER'S
NOTES

A VIEW FROM THE COCKPIT

by Pete “Boomer” Bonanni

As the fighter pilot involved in the creation of *Falcon 4.0*, I’m continually asked, “How close is *Falcon 4.0* to the real thing?” I answer by simply saying that *Falcon 4.0* comes remarkably close to providing the *experience* of flying an F-16. To explain how the MicroProse team has achieved this, I must relate a story told to me by a great fighter pilot named Phil “Hands” Handley.

While flying F-15s out of Germany, Hands had the opportunity to talk with Adolf Galland, the great World War II German ace. Hands told the German ace that it was obvious to him that of Germany’s World War II fighters, the Fw-190 was the superior aircraft based on published performance data. The Fw-190 was faster, could turn better and could climb higher than the Me-109, the plane in which Galland had recorded most of his kills. Adolf Galland smiled and said that Handley was correct in his analysis of the two aircraft’s relative performances—but wrong in his assessment of which aircraft was superior. The German ace had flown both aircraft and believed that the Me-109 was the superior fighter because “flying it felt like wearing a glove.” It was smooth as silk and easy to control, whereas the Fw-190 was difficult and unruly. Galland could fly the Me-109 to his—and its—maximum performance, and this made it the better combat aircraft.

This story underscores the real challenge of creating a superior flight simulation: getting beyond the performance numbers to provide you with the real “feel” of the aircraft. Some of you have read my online posts about how accurately *Falcon 4.0* models the real jet in performance and avionics. Performance numbers are important, but that’s the easy part of flight simulation development. *Falcon 4.0* is the most accurate model of the F-16 ever developed for the PC, based solely on how well it matches up with real performance charts. What makes the simulation extraordinary, however, is how well it provides the “feel” of the aircraft. How close is that feel? Well, many of you know of Gilman Louie, MicroProse’s Chief Creative Officer. When it comes to the *Falcon* series of games, many people have come and gone throughout the years. Gilman Louie, however, is the one and only *Falcon* constant, the man who launched the original product and provided the vision for every *Falcon* simulation ever produced—including this one.

Recently I had an opportunity to fly Gilman in the back seat of an F-16. Gilman had logged many hours on *Falcon 4.0* prior to the flight, so I was curious to see how well he could control a real F-16. His performance in the aircraft would give me a rough idea of how well the simulation had re-created the correct “feel” of the jet. I was pleasantly shocked by the results. I talked Gilman through a series of basic maneuvers, and his control of the F-16 was crisp and precise. He also kept the jet within 10 knots of the airspeed and 100 feet of the altitude I specified during the maneuvers. Based on Gilman’s performance, *Falcon 4.0* does a great job of capturing the “feel” of the F-16.

However, *Falcon* is not really about flight models. *Falcon* is about the F-16 air combat experience. I was at a large trade show when a well-known flight sim developer saw the *Falcon 4.0* Campaign. He commented, “Well, Pete, it looks all right but... with this approach, how do you expect to control what the player sees?” My answer was very simple and direct. “It would not be



Falcon if we tried to script what the player sees. *Falcon* is not about controlling the player. *Falcon* is about creating a tactical environment that makes the player look inward.” That answer got me a puzzled look. I did not elaborate then, but I will now. At some point in your *Falcon 4.0* experience, you will realize that you must develop real fighter pilot skills to succeed. You will focus more on your own strengths and limitations as a fighter pilot and less on the simulation. That is what *Falcon* has always been about: developing a “fighter pilot mind-set.” We have a saying in the fighter world: “Not all fighter pilots fly fighters.” Being a fighter pilot is not a thing you do—it is an *attitude*.

We help you create this attitude by building the most realistic air-land battle environment ever put on a PC, and then by resisting the temptation to try to mold it around the player. Modern warfare is unpredictable and difficult to control, and we believe that players will easily see through any clumsy attempts to script this chaos into bite-sized chunks. *Falcon 4.0*’s dynamic war is *player-influenced* but not *player-driven*. We’re not really sure what specific events you will see, but we are sure you will be plunged into the maelstrom of modern air combat. Success or failure will depend on you. There are no shortcuts, no tricks and no little man behind the curtain. You must become a fighter pilot to fight and win in *Falcon 4.0*.

A VIEW FROM THE COMPUTER

by Gilman “Chopstick” Louie

Flight simulators and combat simulators are the closest you can get to military experience short of joining the armed forces or spending \$10,000 to fly a real Russian MiG. Today’s games have higher graphics fidelity than the military flight simulators that governments used to train pilots just a few years ago. Combine today’s games with a 3-D graphics card, flight stick and throttle... and you have a simulator very representative of the real aircraft.

THE COMPROMISE OF FLIGHT SIMULATION DESIGN

When we worked on a low-cost *Falcon*-based F-16 trainer for the government 10 years ago, a colonel told me that if you ask designers to create a simulator without any compromises, they would end up designing the aircraft itself. The art of simulation design is about understanding limited fidelity. Even in multimillion-dollar simulators, compromises must be made. Designers have to consider cost vs. fidelity and processor time vs. fidelity. Additional trade-offs must be made between graphics, AI, flight models, number of units and more. The basic rule in building a flight simulator is to never ask the pilot what he wants because he too will end up building an airplane. Instead, ask the pilot what he needs to *learn*.

In *Falcon 4.0*, our goal is to design a F-16 simulator that will put the player’s head into the war, not just into the plane. We want to suspend your disbelief and to give you a better understanding of a pilot’s role in a large-scale engagement. The secret to the *Falcon* series has always been balancing the campaign with the flight simulation.

THE CAMPAIGN AND THE SIMULATION

Ask programmers and designers who work on combat flight simulations what simulation features are critical, and most will define a great sim by how accurate the flight model and avionics are. Create a set of prescribed missions along with a few videos and *voilà*... you have a simulation.

Unfortunately, to create a *great* simulation, a flight model, avionics, enemy AI and good graphics are only the start. The purpose of the *Falcon* series is not just to simulate the aircraft but the entire fighter pilot experience. Our goal has been not just to replicate the flight dynamics, avionics and visuals of flight, but to include the elements that make up the combat environment.

Falcon 4.0 is comprised of two completely separate simulations: *the Campaign* and *the Air Combat Simulation* (ACS). While most games focus only on the ACS, *Falcon 4.0* spotlights the campaign. Under the realistic F-16 flight combat simulation lies a complete strategy war game engine. The Campaign system features tens of thousands of units moving, reacting and fighting throughout Korea. The Campaign is based on a virtual environment we call the Virtual Universe, which maintains and updates the complete database of units. *Falcon 4.0* is the only flight simulator in which you can watch a complete war unfold without ever getting into the F-16 flight simulation itself. Unlike *Falcon 3.0*, *Falcon 4.0*'s campaign system is designed to run constantly.

Flight of the Intruder and *Falcon 3.0* revolutionized the air combat sim by introducing wingmen. Pilots do not go into battle alone; if they did, they would be dead. *Falcon 4.0* extends the wingmen concept with flights, packages and group missions. *Falcon 4.0* re-creates what happens in a theater-wide campaign in which the F-16s are a part of a bigger war effort. *Falcon 4.0* puts you in the position of a real F-16 squadron commander. Time becomes a very important element in mission planning and coordination. Wars can be won or lost by how effectively commanders manage their resources and coordinate their attacks. Arriving a few minutes too early or too late can completely change the outcome of a war.

FLIGHT MODEL

There have been many claims by many companies about how realistic their flight models are, even claims of government-approved flight models. Using raw flight model data is just a starting point. Unless you model the control system as well, the simulation can be sloppy or uncontrollable. The reality is that any real-time flight model developed to run on a PC will be a compromise and an approximation of the real aircraft. A good flight model starts with the data and models, and is then validated against the real aircraft.

Falcon 4.0's flight model was designed by team members who are aeronautical engineers, including one who helped develop the Air Force's F-16 Unit Training Device simulator. Based on actual flight envelope data and performance charts, *Falcon 4.0*'s flight model has been validated by real F-16 pilots who have flown the Block 52 model. The pilots tested this simulation through the entire flight regime, including emergency conditions such as the deep stall.



PILOT OVERLOAD

During the Vietnam War, aircraft designers realized that pilots were being overloaded. It became impossible for them to manage all of the aircraft's offensive and defensive systems while flying the plane. These human factors therefore became a priority in Western aircraft design. As a result, today's planes are designed so that the human-machine interface is as seamless as possible. Over the past two decades, Western designers have not only reduced the workload on the pilots but have also made human factors a tactical advantage. As one fighter pilot told me, modern combat aircraft are easier to fly than a Cessna. When flying the F-16, you virtually become a part of the aircraft.

GRAPHICS

One of the most immediate differences between *Falcon 3.0* and *Falcon 4.0* is the game's graphics. With the advent of 3-D hardware accelerators and faster processors, *Falcon 4.0*'s 3-D graphics exceed the requirements of many government simulators. But even though 3-D acceleration and faster processors have greatly improved the graphics, trade-offs must still be made. Examples include the level of terrain detail vs. area of terrain displayed, the quality of 3-D objects vs. the number of 3-D objects displayed, and special effects vs. frame rate. Our emphasis in *Falcon 4.0* was gameplay first and then the display of the necessary graphical information that real pilots see in flight. We have re-created visual cues such as canopy reflections, dust from moving ground units and smoking aircraft engines to improve your situational awareness. While eye candy is important, graphics should not come at the expense of the simulation's fidelity.

TERRAIN

The design team was tasked with developing a terrain system that could reproduce the entire Korean peninsula, more than 786,000 square kilometers. Their first thought was to use straight satellite data. While good on paper, straight satellite data has enormous problems. First, high-resolution data for both North and South Korea was not readily available. Second, the resolution of the "declassified" satellite image data was too low. While the graphics looked good from 30,000 feet, it was rough and pixelated down low. Third, the amount of data needed for this approach would be too big for the average PC to handle. Instead, the team decided to use tiled 3-D graphics.

The team used real high-resolution aerial reconnaissance images and created 3-D tiles that could be assembled to create realistic-looking terrain, regardless of altitude. Next, they mapped those tiles over elevation maps of Korea. Finally, they added high-resolution 3-D objects such as airports, buildings, bridges and other landmarks. One trade-off with this approach is higher resolution at lower altitudes vs. some repetitiveness at high altitudes. We believe that this is a good approach since low-altitude resolution is important in *Falcon 4.0* for ground cueing, especially for low-altitude missions.

BEYOND THE BUBBLE

One of the greatest shortcomings of flight simulations is the limit imposed by their visual bubbles. Most games are designed to draw objects only if they are within a visual bubble (typically 5–15 miles), creating a “horizon effect.” Some flight simulators attempt to mask this problem by fogging terrain beyond that distance, but then important visual information is lost, information that a real F-16 pilot would have. A sharp-eyed pilot, for example, can see the smoke on the horizon given off by a large-scale ground assault. Midair explosions and large air combat engagements can be seen from 25 miles. *Falcon 4.0* looks at far-off events in the campaign and determines if they would be visible to the naked eye. If so, the game displays these events in the simulation even if they are beyond the bubble, practically eliminating the horizon effect.

One advantage of the *Falcon 4.0* design is that the game has two simulations running simultaneously: the flight simulation and the campaign. Since the campaign engine tells the 3-D engine what to draw beyond the bubble, *Falcon 4.0* can display action beyond the player’s visual bubble.

SOUNDS

Many of the sounds that you hear have been digitized from the real F-16, from the button clicks to the engine whine. It is important to realistically reproduce all of the sounds since they are important cues to the players.

Falcon 4.0 also boosts some of the sound effects not audible in the real cockpit. Unlike in a real F-16, where you can feel the aircraft in the seat of your pants and feel the Gs pressing on your body, the game can only re-create the visual and audio aspects of flight. It was therefore important to create a hyper-real sound environment to compensate for the absence of physical feeling.

RADAR AND HUD MODES

Falcon 4.0 accurately simulates radar and HUD modes (short of anything that’s classified). When faced with realistic avionics, you will quickly realize how important it is to be proficient at operating the various weapons and sensor systems. F-16 pilots call it “playing the piccolo.” The military uses specialized trainers that focus just on getting pilots to improve their piccolo playing. While many games focus on the “knife fight” (battle within visual range), air battles are won and lost well beyond the merge.

HYPER-ACTION

For experienced combat pilots, flying the real F-16 is 99% boredom and 1% adrenaline. If *Falcon 4.0* had the same ratio, nobody would buy the game. *Falcon 4.0*, like most games, increases activity levels to keep your interest engaged. The action that you see in one *Falcon 4.0* mission is equivalent to two to five real combat missions. The number of missions you fly in a day has also been exaggerated. On the other hand, *Falcon 4.0* does not feature a super plane with unrealistic performance and weapons (unless you set your game preferences that way). Once in an engagement, the simulation realistically depicts what real F-16 pilots can do.



GLOC

The GLOC (Gravity Induced Loss of Consciousness) model and its tunneling effect in *Falcon 4.0* is representative of what happens to a real pilot. *Falcon 4.0* uses real human factors data to model GLOC (blackout/redout). In high-G maneuvers, your body's G tolerance is reduced based on the cumulative effects of how many Gs you have pulled over a period of time. While your body may initially handle high G loads, your tolerance of Gs will gradually weaken as you continue to stress your body.

TACTICAL ENGAGEMENT

Falcon 3.0 featured the Red Flag mission builder, which gave players the ability to script simple missions. Red Flag focused primarily on a simple-to-use interface used to design small unit engagements. *Falcon 4.0*'s Tactical Engagement was designed after the way real mission planners, who think in terms of packages and timing, plan their missions. Tactical Engagement is designed for medium and large-scale mission design.

USER INTERFACE

We had many ideas about how to change the user interface for *Falcon 4.0*, everything from using a virtual 3-D airbase to using real-time video. After much debate, the team decided to present the information in a format that more closely resembles what real squadrons use. The team had two goals for the user interface: a more open, nonsequential system and speedier setup for the mission and simulation. The focus, especially in the Campaign, is to provide quick and easy access to mission planning. While this approach may be a little more confusing in the beginning, it becomes much more productive and efficient for the experienced player than the linear approach of *Falcon 3.0*.

THE ELECTRONIC BATTLEFIELD SYSTEM

Falcon 4.0 was designed as a multiplayer game from the very beginning. By designing the campaign system and Virtual Universe (VU) first, the human player became one element in a much bigger war. To create a multiplayer game, all we had to do was substitute real players for AI-controlled entities. The VU is based on the government's Distributed Interactive Simulation standards, which are currently being used to network defense simulators. The VU also supports the aggregation and deaggregation of large-scale units, which allows the game to support thousands of entities. *Falcon 4.0* is designed to allow players to jump into and out of the game. This will enable the game to host online players 24 hours a day.

F-16A VS. F-16C

In 1972 the U.S. Air Force asked General Dynamics to build a lightweight fighter prototype, a low-cost day fighter that would be easy to maintain and could be sold to nations with limited financial means. Today, the F-16 is a capable all-weather multirole fighter.

The F-16 has many different variants. The air forces that employ the F-16 consistently upgrade and modernize their aircraft. *Falcon 3.0* modeled one of the early F-16s, the F-16A Block 15. *Falcon 4.0* models the F-16C Block 52. The Block 52's engine generates 29,000 pounds of thrust, 22% greater than the Block 15's turbofan engine, which translates into increased acceleration and ability to pull Gs. The F-16C radar, the APG-68, has been upgraded from the F-16A's APG-66. The APG-68 has several advanced features, including modes such as Range While Search, Track While Scan, Ground Map, Ground Moving Target and Sea (naval). The air-to-ground modes makes the C model a much more effective weapons platform. The biggest difference in air-to-air weaponry is the recent addition of the AMRAAM. With the AMRAAM, the F-16C finally has a reliable BVR (Beyond Visual Range) air-to-air standoff missile.

FLYING THE REAL F-16

A year ago, I was fortunate enough to fly a Virginia Air National Guard F-16D during an incentive flight. Even though we were loaded with two external fuel tanks and some external stores, I was still impressed with the performance of the re-engined F-16. We were able to go from a standing start to 10,000 feet in less than a minute. The most impressive part of the flight was how easy it was to control the F-16D. The plane was very responsive, yet I had no trouble controlling it. Within a few minutes of going up, I felt a part of the flight control system. The HOTAS (Hands on Throttle and Stick) allowed me to keep my hands on the controls without worrying about finding the appropriate switches in the cockpit.

One of the things I most appreciated was how difficult it is to spot aircraft while flying. When we went up, it was a hazy day in Virginia—conditions similar to what a pilot might expect over Korea. At 20,000 feet, the ground was a muddy brown and hard to make out. During our mission, we crossed paths with two F-16s. Even with my contact lenses in, Pete spotted the F-16s a good 20 seconds before I saw them. I guess that's why we do simulations and pilots fly the real birds.

FINAL THOUGHTS

Military combat flight simulators have always been somewhat controversial. Do these games end up glorifying war? We at MicroProse try to design simulators that help educate individuals who are interested in what it is like to fly modern military aircraft. Unlike computer games, real aircraft have no reset buttons. In real planes, real people die. Nations around the world ask their sons and daughters to put their lives on the line to help defend their own countries and their sovereignty. We hope this product helps all of us better appreciate what we ask these people to do and the sacrifices they make.

APÊNDICE

B



GLOSSÁRIO

A-A – Ar-Ar (Air-to-Air).

AAA – Artilharia Antiaérea (Anti-Aircraft Artillery).

AAM – Míssil ar-ar (Air-to-Air Missile).

AB – Pós-combustor (Afterburner).

ACM – Modo de combate aéreo (Air Combat Mode).
Um radar ar-ar de curto alcance que automaticamente adquire o alvo mais próximo.

ACMI – Instrumentação de manobras de combate aéreo (Air Combat Maneuvering Instrumentation). Ela permite que você grave e posteriormente assista a uma gravação visual de seu vôo.

Acoplamento amigo (buddy spike) – Chamada de rádio que indica que uma aeronave acoplou seu radar a uma aeronave amiga. Emitido como alerta para não disparar.

ADI – Indicador direcionador de atitude (Altitude Direction Indicator). A esfera no centro do painel de instrumentos que exibe precisamente a arfagem e o rolamento da aeronave.

A-G – Ar-Terra (Air-to-Ground).

AGL – Altitude acima do nível do solo. (Altitude Above Ground Level).

AGM – Míssil ar-terra (Air-to-Ground Missile).

AGM-65 – Míssil ar-terra Maverick.

AGM-88A – Míssil anti-radiação de alta velocidade ou HARM (High-Speed Anti-Radiation Missile), (anti-radar).

AGR – Alcance ar-terra (Air-to-Ground Ranging).

AIM – Míssil de interceptação aérea (Air Intercept Missile).

AIM-120 – AMRAAM guiado por radar.

AIM-7 – Míssil de médio alcance guiado a radar, conhecido como Sparrow.

AIM-9M – Míssil de interceptação aérea de disparo de qualquer ângulo.

AIM-9P – Míssil de interceptação aérea de disparo por trás.

ALQ-131 – Um casulo de interferência montado na parte inferior do F-16, projetado para agir contra radares inimigos.

ALR-56M – O sistema de alerta contra ameaças (TWS – Threat Warning System) do F-16. Ele detecta radares que iluminam sua aeronave e determinam seu tipo, força e rumo.

ALT – Altitude acima do nível do mar.

Amanhecer (sunrise) – Chamada de rádio que indica que um AWACS começou a prover funções de controle a aeronaves amigas.

AMRAAM – Advanced Medium-Range Air-to-Air Missile. Um míssil guiado por radar, também designado AIM-120.

AN/APG-68 – O sistema de radar usado pelo F-16.

Angels – Chamada de rádio que indica a altitude em milhares de pés. “Angels 1” = 1.000 pés, “Angels 27” = 27.000 pés, etc.

Ângulo de Ataque – O ângulo, medido em graus, entre a arfagem da aeronave e o vôo nivelado.

Antena (bullseye) – Um ponto geográfico predeterminado usado como referência para algumas chamadas de rumo e alcance, em vez da referência individual de um piloto.

AOA – Ângulo de ataque (Angle Of Attack).

APC – Veículo blindado de transporte de tropas (Armored Personnel Carrier).

Arfagem – Movimento ao longo do eixo horizontal de uma aeronave que faz com que o nariz da mesma gire para cima e para baixo.

Arizona – Chamada de rádio que indica que a aeronave esgotou seus mísseis anti-radiação.

Armamento – As armas transportadas por uma aeronave.

Ataque – Missões ar-terra executadas contra uma ampla variedade de alvos inimigos. Estes alvos podem consistir de qualquer coisa, desde infra-estruturas a unidades terrestres inimigas.



Ataque OCA – As missões de ataque OCA são essencialmente missões ar-terra desempenhadas contra alvos dentro e ao redor de uma base aérea inimiga.

Ataque SEAD – Missões ar-terra executadas contra efetivos de defesa aérea, tais como SAMs e radares de busca. Em uma missão de ataque SEAD, você deve destruir recursos de defesa aérea inimigos específicos.

Atirador/atirador – Chamada de rádio que indica que tanto o líder da esquadrilha quanto o ala atacarão o alvo designado.

Atirador/cobertura – Chamada de rádio que indica que o líder da esquadrilha atacará o alvo designado, enquanto o ala dá cobertura contra AAA ou aeronaves inimigas.

Atrelado (Slave) – Um submodo de armas que acopla a mira da arma à posição atual do radar.

Augured in – Chamada de rádio que indica que uma aeronave colidiu contra o solo.

AVTR – Gravador de fita de vídeo aerotransportado (Airborne Video Tape Recorder). O gravador (filmadora) de vídeo do F-16 que é automaticamente ativado quando a ACMI é acionada.

AWACS – Sistema de alerta e controle aerotransportado (Airborne Warning And Control System). Aeronaves de AWACS, tais como o E-3, controlam combates aéreos e fornecem informações de radar superiores.

Azimute – O rumo, em graus, de um alvo em relação ao piloto, sendo que o rumo corrente corresponde a zero.

Azimuthes variados (Azimuth split) – Chamada de rádio que indica que múltiplos grupos de aeronaves inimigas estão em rumos diversos, em relação ao piloto.

Baixo nível (bingo) – Nível de combustível preestabelecido o qual, quando alcançado, determina que a esquadrilha encerre ou aborte sua missão para retornar com segurança à base.

Bandido – Uma aeronave hostil confirmada.

Bandido suspeito (outlaw) – Uma aeronave que se suspeita ser hostil.

BARCAP – Patrulha aérea de combate de barreira (Barrier Combat Air Patrol). Esta missão ar-ar é realizada para proteger uma via de acesso por um dado período de tempo. Ela é bastante parecida com a missão DCA, exceto que uma missão DCA é mais ligada a um objetivo (recurso) específico, enquanto as BARCAPs são usadas para proteger uma via, ou avenida de acesso, da aproximação inimiga. Você precisa manter-se no posto pelo tempo determinado ou até que você receba permissão do AWACS para deixar a CAP.

Básica – Uma formação de linha de frente em que as aeronaves formam um leve zigzague.

Batalhão – Uma unidade do exército que consiste de três companhias.

BDA – Estimativa de danos de combate (Battle Damage Assessment) As missões de BDA são idênticas a missões de reconhecimento, exceto que elas são executadas para se obter fotos pós-ataque da área-alvo. Essas missões ajudam os planejadores a estabelecer a extensão dos danos causados a uma área-alvo específica.

Big Bird – Um sistema de radar de fabricação soviética.

Blackout – Perda da visão (ou consciência) decorrente de se puxar muitos Gs positivos. Consulte *GLOC*.

Bombas de ferro – bombas de queda livre padrão, que detonam ao impacto.

Bracketing – Uma manobra ofensiva em que duas aeronaves em aproximação se separam, de modo que cada uma passa de um lado da aeronave inimiga.

- Break** – Comando de rádio que orienta uma manobra súbita de alto G em uma direção especificada. Normalmente emitido quando um míssil ou aeronave inimiga está na cauda do destinatário da mensagem.
- Break X (recuperar)** – Um indicador que aparece no HUD como um grande “X”, que indica que você está prestes a colidir contra o solo ou contra uma aeronave acoplada no radar.
- Briga de Facas (Knife Fight)** – Terminologia de pilotos para um combate realmente próximo.
- Brigada** – Uma unidade do exército que consiste de três a cinco batalhões.
- BSTG** – Um submodo de lançamento de armas que atrela o SOI à mira da linha de visada do HUD, em vez do radar Ground Map.
- Bunt** – Empurrar o manche ligeiramente para frente.
- BVR** – Além do alcance visual (Beyond Visual Range).
- CAP** – Patrulha aérea de combate (Combat Air Patrol).
- Cargas externas** – Os armamentos, casulos e tanques de combustível transportados por uma aeronave.
- CAS** – (1: missão.) Suporte aéreo aproximado (Close Air Support). Missões de CAS são missões de ataque realizadas contra unidades do exército inimigo que estão bastante próximas de forças amigas. Alvos de CAS específicos normalmente são passados ao caça de um FAC. (2) Velocidade em relação ao ar calibrada (Calibrated Airspeed).
- CBU** – Unidade de bombas em cacho (Cluster Bomb Unit).
- CCC ou “C³”** – Comando, Controle e Comunicações.
- CCIP** – Ponto de impacto calculado continuamente (Continually Computed Impact Point). Um submodo ar-terra, para bombardeio.
- CCRP** – Ponto de lançamento calculado continuamente (Continually Computed Release Point). Um submodo ar-terra, para bombardeio.
- CDI** – Course Deviation Indicator (Indicador de desvio de curso). Um ponteiro no HSI que se desvia de modo a mostrar sua posição em relação ao curso selecionado.
- Chaff** – Contramedidas que consistem de pequenas tiras de lâminas metálicas, projetadas para confundir mísseis guiados por radar.
- Chainsaw** – Uma manobra em que você dispara um AIM-120 e o deixa.
- Cheque as seis horas (check six)** – Chamada de rádio que indica que você deve olhar para trás de você, em busca de mísseis ou aeronaves inimigas aproximando-se.
- Chick** – Uma aeronave amiga.
- Círculos de Ameaça** – Raios de detecção de radar ao redor de instalações de SAM inimigas.
- Cobrinha** – Uma formação em que cada aeronave fica atrás da outra, formando uma fila.
- Código de chamada (callsign)** – Um codinome de um piloto de caça específico.
- Cold (frio)** – Situação em que a cauda de uma aeronave inimiga está na direção do piloto.
- Colega (playmate)** – Aeronave amiga envolvida na missão atual do piloto.
- Combate aéreo corpo-a-corpo (dogfight)** – Um engajamento ar-ar de manobras com aeronaves inimigas.
- Combustível de abandono (joker)** – Chamada de rádio que indica que há combustível suficiente apenas para retornar à base. Não resta mais nada de reserva para emergências.
- Companhia** – Uma unidade do exército que consiste de três pelotões.



- Continue conforme instrução (continue as fragged)** – Chamada de rádio que indica que você deve continuar a missão de acordo com o que foi instruído.
- C-P** – Ponto de contato (Contact Point). Um ponto de curva no qual o FAC deve ser contactado.
- CTA** – Controle de Tráfego Aéreo.
- Cubra-me, cobertura** – Chamada de rádio que indica que um ala deve adotar um papel de cobertura e proteger o líder.
- Cunha** – Uma formação de aeronaves em cunha.
- Dakota** – Chamada de rádio que indica que os armamentos ar-terra de uma aeronave se esgotaram.
- DBS** – Aumento de nitidez por feixe (Doppler Doppler Beam Sharpening). Um submodo do radar GM que permite ao piloto estreitar o feixe do radar para obter maior resolução.
- DCA** – Defensiva contra ameaças aéreas (Defensive Counter Air). Consiste de uma missão ar-ar realizada para proteger um recurso, tal como forças de terra ou uma aeronave de AWACS. Uma parte crítica da missão DCA é permanecer “no posto” pelo período de tempo prescrito. Não deixe sua área de DCA até que seu tempo “no posto” tenha sido concluído, ou você tenha recebido permissão do AWACS.
- Dê motor (buster)** – Comando de rádio para voar o mais rápido possível.
- DED** – Mostrador de entrada de dados (Data Entry Display) mostrador de entrada de dados. O mostrador de informações localizado acima do MFD direito.
- DGFT** – Modo Dogfight (combate aéreo corpo-a-corpo).
- Divisão** – Uma unidade do exército que consiste de três ou quatro brigadas.
- DLZ** – Zona de lançamento dinâmico (Dynamic Launch Zone). O alcance entre Rmin e Rmax dentro do qual um míssil pode ser disparado de forma a ser capaz de atingir o alvo.
- DTOS** – Submodo ar-terra de arremesso em mergulho (Dive Toss Air-to-Ground)
- Ducks** – Designação alternativa de iscas para mísseis.
- ECM** – Contrainformações eletrônicas (Electronic Countermeasures). Um casulo levado sob a aeronave que usa ondas eletromagnéticas para interferir ou confundir os radares inimigos.
- EEGS** – Mira de canhão de envelope aumentado (Enhanced Envelope Gun Sight). Uma mira de canhão que exhibe um funil, para ajudar a rastrear um alvo em um combate aéreo corpo-a-corpo.
- EFOV** – Campo de Visão Estendido (Extended Field of View)
- Entrada (ingress)** – Entrada ou aproximação de um objetivo.
- EO** – Eletroóptico. Um modo do MFD que exhibe uma visão de câmera para rastrear e acoplar alvos terrestres.
- Escolta** – Missões de escolta são desempenhadas para proteger aeronaves que estão ingressando em território inimigo. Você deve impedir que caças inimigos derrubem as aeronaves que você está protegendo.
- Escolta SEAD** – Missões executadas para suprimir defesas aéreas inimigas para a proteção de um grupo ou grupamento de aeronaves específico. Ao contrário das missões de ataque SEAD, não é necessário realmente destruir sistemas de defesa aérea inimigos para executar com sucesso uma missão de escolta SEAD. Supressão, não destruição, é o objetivo de uma missão de escolta SEAD.
- Esquadrão** – Uma unidade do exército que consiste de aproximadamente 12 homens ou 4 veículos.

Esteiras de condensação – Rastros de vapor deixados na esteira de uma aeronave gerados por curvas de alto G.

ETA – Tempo estimado de chegada (Estimated Time of Arrival)

ETE – Tempo estimado a caminho (Estimated Time Enroute).

F-15 – O Eagle é um caça ar-ar norte-americano, também capaz de missões de ataque ao solo.

F-16 – O Falcon é um caça norte-americano extremamente manobrável, capaz de realizar diversos tipos de missão.

F-4 – O Phantom II é um caça norte-americano baseado em porta-aviões relativamente antigo, mas que continua sendo útil hoje em dia.

FAC – Controlador aéreo avançado (Forward Air Controller).

Fantasma (“bogie” ou “bogey”) – Um contato visual ou de radar cuja identidade é desconhecida.

FCC – Computador de controle de fogo (Fire Control Computer).

FCR – Radar de controle de fogo (Fire Control Radar).

Fence check – Comando de rádio para checar as armas e sistemas da aeronave para se certificar de que eles são apropriados para a situação.

FIX – Marcar atualização de posição de rastreamento.

Flameout – Todo o combustível se acabou e o motor apagou.

Flares – Contramedidas que consistem de pacotes baseados em magnésio que se incendiam. Usadas para enganar mísseis guiados por infravermelhos.

FLCS – Sistema de controle de voo (Flight Control System). Este sistema impede que o jato fique fora de controle, limitando o que os controles de voo permitem ao piloto fazer.

FLOT – Linha de frente das tropas (Forward Line of Troops).

Fluida – Uma formação básica em que a distância entre as aeronaves é maior.

Fly by Wire – “Vôo por fios”. Um tipo de controle de aeronaves onde o manche e o manete não usam ligações mecânicas às outras partes da aeronave. O F-16 usa este tipo de controle.

Foguetes – Explosivos não guiados transportados por foguetes.

FOV – Campo de visão (Field Of View). Também o termo para armas guiadas por imagens infravermelhas ou de câmera de TV.

Fox Dois – Chamada de rádio que indica um lançamento de míssil guiado por infravermelho.

Fox Três – Chamada de rádio que indica um lançamento de míssil AMRAAM.

Fox Um – Chamada de rádio que indica um lançamento de míssil SARH.

Foxtrot Uniform – F*cked Up (f*errado). “Meu radar está Foxtrot Uniform.”

FPM – Marcador de trajetória de voo (Flight Path Marker). Um pequeno círculo com raios na ponta e nos lados que é exibido no HUD.

Fuga (dragging) – Uma manobra que envolve voar para longe de uma aeronave inimiga como um chamariz, numa tentativa de induzi-la a segui-lo.

Funil de Mira (Aiming Funnel) – Um elemento do HUD no modo DGFT. Consulte EEGS.

G – A força (aceleração) da gravidade. 1 G = gravidade normal, 2 Gs = o dobro da gravidade normal, etc.

GBU – Bomba guiada (Guided Bomb Unit). Uma designação para bombas guiadas a laser, ou LGBs (laser-guided bombs).

GLCC – Perda da consciência induzida por altas forças G (Gravity-Induced Loss of Consciousness).



- GM** – Mapa do solo (Ground Map). Modo de radar é usado para localizar alvos fixos em terra.
- GMT** – Alvo em movimento no solo (Ground Moving Target). Modo de radar usado para localizar alvos em terra em movimento.
- Goose eggs** – Chamada de rádio que indica que todos os pilotos erraram seus alvos.
- Grupamento (package)** – Um grupo de esquadrilhas com uma missão comum.
- Guinada** – Movimento ao longo do eixo vertical de uma aeronave que faz com que o nariz da mesma gire para a direita e para a esquerda.
- HARM** – Míssil anti-irradiação de alta velocidade (High-Speed Anti-Radiation Missile). Designado AGM-88A.
- HART** – Treinamento de recuperação e consciência da buzina (Horn Awareness Recovery Training).
- HARTS** – Abrigo de artilharia reforçado (Hardened Artillery Shelter). Um canhão de artilharia enterrado em uma encosta de colina, e bem protegido por concreto.
- Hora de partir** – Horário para sair de um ponto de curva.
- Hostil** – Uma aeronave identificada como inimiga.
- HOTAS** – Mãos no manete (acelerador) e no manche (Hands on Throttle and Stick). Controles que permitem a pilotos controlar operações de combate críticas sem tirar suas mãos do manete ou do manche (os controles ficam no próprio manete e manche).
- Hound Dog** – Chamada de rádio de solicitação de permissão para engajar.
- HSD** – Mostrador de situação horizontal (Horizontal Situation Display). Uma página do MFD que mostra as posições relativas de pontos de curva, e indica uma rota de voo.
- HSI** – Indicador de situação horizontal (Horizontal Situation Indicator). Usado para posicionar a aeronave na aproximação final, quando a pista de pouso não está visível.
- HTS** – Sistema de aquisição de alvos de HARM (HARM Targeting System). Um casulo montado na aeronave que detecta alvos para o míssil HARM.
- HUD** – Visor frontal (Head-Up Display). Um painel transparente na parte superior frontal da cabine, em frente ao pára-brisa, que exibe informações de navegação e armamentos importantes.
- IADS** – Sistema integrado de defesa aérea (Integrated Air Defense System).
- ICP** – Painel de controle integrado (Integrated Control Panel). O painel de controle imediatamente abaixo do HUD.
- IFF** – Identificação amigo/inimigo (Identification Friend or Foe).
- IFV** – Veículo de combate de infantaria (Infantry Fighting Vehicle).
- II-76** – O Candid é uma aeronave de transporte de fabricação soviética extremamente grande.
- ILS** – Sistema de pouso por instrumentos (Instrument Landing System). Linhas horizontais e verticais que aparecem no centro do HUD, para auxiliar o pouso.
- INS** – Sistema de navegação inercial (Inertial Navigation System). Equipamento de navegação, dentro da aeronave, que acompanha sua posição com base nos movimentos realizados após a decolagem.
- Invadindo (trespass)** – Chamada de rádio que indica que uma esquadrilha amiga entrou no anel de ameaça de um SAM inimigo.
- IR** – infravermelho (infrared). Também a designação de mísseis guiados por calor.
- Jink** – Manobra imprevisível feita para estragar a pontaria de um piloto inimigo.
- JSTARS** – Sistema conjunto de radar de vigilância e aquisição de alvos (Joint Surveillance and Target Acquisition Radar System).

Juliet Sierra – Chamada de rádio que indica que todos os pilotos erraram seus alvos.

Kansas – Chamada de rádio que indica que a aeronave esgotou seus armamentos ar-ar.

KC-10 – O Extender é a maior aeronave de reabastecimento em voo dos EUA atualmente em operação.

Lawn dart – (1) Chamada de rádio que indica que uma aeronave colidiu contra o solo. (2) Um nome pejorativo para o F-16.

LCOS – Mira óptica de adiantamento do computador (Lead Computing Optical Sight). Uma mira de canhão ar-ar.

Leakers – Aeronaves inimigas que avançaram além das escoltas.

LGBs – Bombas guiadas a laser (Laser-Guided Bombs).

Líder de elemento – A aeronave número 3 em uma esquadrilha de 4 aeronaves.

Limite de Varredura – A área máxima em que um radar ou linha de visada pode operar. Exceder o limite de varredura faz com que mísseis percam seu acoplamento.

Limpa – Uma aeronave não carregada com qualquer carga externa.

Limpo e claro (clean and naked) – Chamada de rádio que indica que não há inimigos à vista ou no radar. Nenhum sinal no RWR.

Linha de frente – formação em que as aeronaves ficam lado a lado, ponta de asa com ponta de asa.

Lista Frag – Uma lista de alvos militares ordenados por prioridade.

LOS – Linha de visada (Line Of Sight).

Mach 1 – A velocidade do som ao nível do mar.

Magnum – Uma designação alternativa do míssil HARM.

Manpads – Sistemas de defesa aérea transportáveis por um homem (Man Portable Air Defense Systems).

Mapa de Engajamento – Um mapa detalhado da Coreia que inclui os pontos de curva de sua esquadrilha.

Marcação – A prática de uma aeronave marcar visivelmente uma posição com foguetes, flares, deixando esteiras de condensação ou através de outros métodos.

Maverick, míssil – Um míssil AGM-65.

MCBs – Manobras Básicas de Combate.

Meia noite (midnight) – Chamada de rádio enviada pelo AWACS que indica que ele não é mais capaz de prover funções de controle a aeronaves amigas.

MFD – Mostrador multifunção (Multifunction Display). Há dois desses mostradores na cabine, um de cada lado do console central. Eles são capazes de mostrar todos os modos de radar, incluindo os de navegação e combate, bem como outras informações vitais.

MiG-19 – O Farmer é um caça de fabrico soviético de mais de 40 anos de idade ainda em uso por diversas nações, inclusive a Coreia do Norte.

MiG-25 – O Foxbat é um interceptador de fabrico soviético de alta velocidade e teto de voo elevado.

MiG-29 – O Fulcrum é um caça de fabrico soviético bastante eficaz, com características de projeto semelhantes àquelas adotadas no F-16.

Mike-Mike – Código para milímetros usado para descrever calibres de AAA. Por exemplo, “23 mike-mike”.

Míssil anti-radiação – Um míssil que é guiado (mira) pela radiação eletromagnética produzida por um radar.

mn – Milhas náuticas. Uma milha náutica equivale a, aproximadamente, 1,3 milhas padrão, ou 1,85 km.



- Movers** – Veículos terrestres.
- MRGS** – Linhas de mira de canhão de referências múltiplas (Multiple Reference Gun Sight).
- MRM** – Míssil ar-ar de médio alcance (Medium Range Air-to-Air Missile) (AIM-120 ou AIM-7).
- MSL** – (1) A altitude acima do nível do mar (Mean Sea level). (2) Modo de anulação para mísseis (Missile override mode).
- Mud** – Indicação de radar de terra inimigo no RWR.
- Music** – Chamada de rádio que indica que o equipamento de ECM está ativo.
- NAV** – Modo de Navegação. A configuração padrão do HUD, que o guia para pontos de curva predeterminados com um pequeno marcador de trajetória de voo em forma de losango.
- NCTR** – Reconhecimento de alvos não cooperativo (Non-Cooperative Target Recognition). Um sistema usado no F-16 em vez do IFF para identificar uma aeronave como amiga ou inimiga.
- Nevada** – Chamada de rádio que indica que a aeronave esgotou seus mísseis Maverick.
- No joy** – Chamada de rádio que indica que o piloto não consegue achar o alvo.
- NOE** – Estilo de voo rasante (Nap Of the Earth). Voar o mais baixo possível, para evitar a detecção por radares inimigos.
- Nós** – Milhas náuticas por hora. Uma milha náutica equivale a aproximadamente 1,3 milhas padrão, ou 1,85 km.
- Notching** (manobra evasiva) – Executar uma manobra de través para romper o acoplamento de um radar.
- OBE** – Ordem de Combate Eletrônica (Electronic Order of Battle).
- OCA** – Ofensiva contra ameaças aéreas (Offensive Counter Air). Missões OCA são executadas contra os recursos ar-ar inimigos. Há dois tipos de missão OCA: Varredura OCA e Ataque OCA.
- ODC** – Ordem de Combate. A ODC mostra todas as unidades disponíveis na campanha.
- OSB** – Botão de seleção de opção (Option Select Button). Os OSBs são botões que cercam os mostradores MFD, que lhe permitem selecionar rapidamente opções de sistema nos MFDs.
- OTA** – Ordem de Tarefa Aérea.
- Pelotão** – Uma unidade do exército que consiste de três esquadrões.
- Pescaria** (trolling) – Tentar fazer o inimigo disparar para localizá-lo.
- Pickling** (liberar) – Pressionar o botão “pickle” (liberação) para lançar bombas, disparar mísseis ou qualquer outra função para o qual ele estiver configurado.
- Piloto automático** (Autopilot) – um equipamento que permite que uma aeronave voe por si própria.
- Pinça**, ou dispersão (pince) – Uma manobra em que o líder da esquadrilha e o ala voam para lados opostos de um inimigo se aproximando.
- Pk** – Probability of Kill (Probabilidade de acerto).
- Plote Único** – Uma formação cerrada concebida para ocultar o número de aeronaves da esquadrilha.
- Ponto de curva** – Um marcador de navegação que indica curso e destino.
- Ponto de encontro** – Um ponto de curva designado.
- Ponto de fixação** (hardpoint) – uma área estruturalmente reforçada, na parte exterior da aeronave, em que cargas externas (bombas, combustível, etc.) podem ser instaladas.
- Ponto de mira verdadeiro** (Aimpoint true) – Chamada de rádio que indica que as armas atingiram o alvo causando o efeito desejado.
- Pós-combustão** – Aceleração muito além e acima da potência militar normal, alcançada pulverizando-se combustível diretamente na parte posterior da turbina.

Posthole (mergulho) – Uma manobra que envolve mergulhar em direção ao solo para evitar ser detectado pelo radar de um inimigo aproximando-se.

Potência Militar – 100% de empuxo, sem uso de pós-combustão.

Print – Chamada de rádio que indica que um contato de radar foi identificado.

R. Combate – Regras de combate, ou regras de engajamento.

Radar – Detecção e alcance por rádio (Radio Detection And Ranging).

Rampa de Arfagem – Um indicador no centro do HUD que consiste de linhas paralelas que mostram o ângulo de ascensão ou descida.

Ray Gun – Chamada de rádio que significa que o piloto acoplou a um alvo não identificado na seguinte posição. Por exemplo, se você ouvir “Fury 12, Ray Gun, antena 030 por 20,” você deve responder com “Acoplamento amigo”, se você estiver nesta posição.

RC – República da Coreia (Coreia do Sul).

RDPC – República Democrática Popular da Coreia (Coreia do Norte).

Recon – Reconhecimento. As missões de reconhecimento são executadas para se obter fotos de um alvo inimigo. Para executar uma missão de reconhecimento com sucesso, você deve voar sobre o alvo com um casulo de câmera transportado pelo jato.

Redout – A perda de visão (ou consciência) decorrente de se puxar muitos Gs negativos.

RESCAP – Patrulha aérea de combate de resgate (Rescue Combat Air Patrol).

Retícula de mira – Um indicador no HUD que mostra o ponto de impacto de uma arma específica.

Rifle – Chamada de rádio que indica que um míssil Maverick foi disparado.

Rmax – O alcance máximo dentro do qual um míssil pode ser disparado com chances de atingir o alvo.

Rmin – O alcance mínimo a partir do qual um míssil pode ser disparado com chances de atingir o alvo.

Rockeyes – Palavra-código usada para uma variante de bomba em cacho.

RTB – Return to Base (retornar à base). Chamada de rádio que indica que um piloto deve retornar a sua base.

Rumo – Um número de três dígitos que indica a direção em graus, variando de “005” a “360.”

RWR – Receptor de alerta de radar (Radar Warning Receiver). Um sistema passivo que alerta o piloto a respeito do lançamento de mísseis e missões de radar inimigas.

RWS – Mostra alcance enquanto busca (Range While Search). Um modo de busca ar-ar de radar.

SA-13 – O sistema SAM Gopher é uma versão grandemente melhorada do S-A 9 “Gaskin”.

SA-2 – O Guideline está entre os maiores e mais antigos sistemas SAM de fabrico soviético.

SA-3 – O Ganef é um sistema SAM de fabrico soviético que dispara mísseis de grande porte, capazes de superar virtualmente qualquer aeronave.

SA-5 – O Gammon é um sistema SAM de fabrico soviético de alta velocidade e grande altitude, mas pouco preciso contra aeronaves modernas.

SA-6 – O Gainful é um sistema SAM de fabrico soviético melhorado, que representa uma certa ameaça a aeronaves de combate modernas.

SA-7 – O Grail é um SAM de fabricação soviética lançado do ombro de capacidade limitada.

SA-8 – O Gecko é um sistema SAM de fabricação soviética menor e de maior mobilidade, concebido para substituir AAA mais antiga.

SAD – Localizar e destruir (Search And Destroy).



Saída (egress) – Deixar uma área de alvo ou engajamento.

SAM – (1) Surface-to-Air Missile (míssil terra-ar) (2) Modo de percepção da situação (Situation Awareness Mode). Um modo automático do radar RWS que lhe permite simultaneamente rastrear um único alvo e ver o que está nas proximidades.

SAR – Busca e resgate (Search And Rescue).

SARH – Guia por radar semi-ativo (Semi-Active Radar Homing). Um míssil que exige que o alvo esteja acoplado pelo radar até o impacto.

SEA – Modo de radar Ground Map otimizado para uso no mar.

SEAD – Supressão de defesas aéreas inimigas (Suppression of Enemy Air Defenses).

Sidewinder – Designação alternativa dos mísseis AIM-9.

Sierra Hotel – Sh*t Hot. Um termo usado para descrever os melhores pilotos.

Silenciador de alertas sonoros – Silencia os sons de alerta de trem de pouso e velocidade baixa.

Skosh – Chamada de rádio que indica que a aeronave esgotou seus mísseis de radar ativo.

Snapshot – Chamada de rádio que indica uma diretiva de disparar um míssil HARM em um alvo terrestre.

SMS – Sistema de gerenciamento de armamentos (Stores Management System). Esta página exibe os armamentos atualmente carregados na aeronave.

SNAP – Snapshot (Tiro rápido). Um modo de canhão ar-ar.

Sniper – Chamada de rádio que indica uma diretiva de disparar um míssil HARM em um alvo que consiste de um radar terrestre emitindo.

SOI – Sensor de interesse (Sensor Of Interest).

Sparrow – Designação alternativa do míssil AIM-7

Spike – Uma indicação de radar de interceptação aérea inimigo no RWR.

Splash One (Um derrubado) – Chamada de rádio que indica que um piloto abateu uma aeronave.

Spoof – Evadir-se de mísseis através do uso de chaff e/ou flares.

SRM – Míssil ar-ar de curto alcance (Short-Range Air-to-Air Missile).

STBY – Standby (Aguardo). O radar não está emitindo.

Stinger – Um SAM lançado de ombro dos EUA altamente eficaz.

STRF – Strafe (Ataque ao solo). Um modo ar-terra que fornece uma retícula para atacar alvos terrestres com o canhão de 20 mm.

STT – Rastreamento de alvo único (Single Target Track). Um modo de radar ar-ar que lhe permite rastrear um único alvo.

Surtida – uma única missão que se desenrola da decolagem ao pouso. No Falcon 4.0, surtidas são engajamentos curtos, centrados em uma missão ou um objetivo tático.

T-80 – Um tanque principal de combate de fabricação soviética mais rápido, mais bem armado e equipado com melhor blindagem que o T-72.

TACAN – Navegação aérea tática (Tactical Air Navigation). Um sistema na cabine que detecta e contata radiofaróis para auxiliar a navegação e exibe as informações no DED.

Tally Ho (visual) – Chamada de rádio que indica que um fantasma ou alvo foi detectado.

Tango Uniform – Chamada de rádio que indica que algo está fora de ação, quebrado ou não está funcionando.

Taxa de fechamento – A razão na qual a aeronave na mira está se aproximando de seu F-16 (número positivo) ou se afastando (número negativo).

TD – Designador de alvo (Target Designator).

TMS – Chave de gerenciamento de alvos (Target Management Switch).

TOS – Horário sobre o ponto de curva (Time Over Steerpoint).

TOT – Horário sobre o alvo (Time Over Target).

Traquear (“padlocked”) – Manter os olhos “travados” no alvo corrente movendo a cabeça para seguir o movimento do alvo.

Través – aeronaves inimigas voando em um ângulo reto em relação à trajetória de vôo de um piloto, numa tentativa de romper ou impedir um acoplamento de radar.

Tu-16 – O Badger é um bombardeiro médio de fabricação soviética com capacidade nuclear e antinavio.

Tumbleweed – Chamada de rádio que indica que um piloto não possui a percepção da situação.

TWS – (1) Rastreia enquanto varre (Modo Track While Scanning). Um modo ar-ar que lhe permite rastrear até 10 alvos simultaneamente. (2) Sistema de alerta de ameaças (Threat Warning System).

UFC – Controles frontais (Upfront Controls)

Varredura – uma patrulha agressiva dentro de território inimigo.

Varredura OCA – Estas missões são o componente ar-ar da OCA, cujo propósito é abater aeronaves inimigas. Como você não estará amarrado a proteger algo ou alguém em missões de varredura, elas oferecem o máximo de flexibilidade ao piloto. Em uma missão de varredura OCA, você voa ao longo de uma rota e engaja quaisquer caças inimigos detectados.

Velocidade em relação ao ar ou velocidade do ar (Airspeed) – A velocidade de uma aeronave em relação ao ar que a rodeia.

Vetor – Rumo e distância a um alvo ou destino.

VMS – Sistema de mensagens de voz (Voice Message System). Uma voz de computador que fornece alertas verbais em situações potencialmente perigosas.

VS – Busca de velocidade (Velocity Search). Um modo de busca de radar ar-ar que só lhe permite rastrear um alvo se seu ângulo aparente for de 91° ou mais, em relação a sua posição relativa.

Vulcan – (1) Designação alternativa do sistema de AAA M163 Vulcan. (2) O nome do canhão de 20 mm montado no F-16.

WEZ – Zona de aquisição do alvo (Weapons Engagement Zone).

Wild Weasel – Uma missão de caça de SAMs.

Willie Pete – Fósforo branco (White phosphorus).

Winchester – Chamada de rádio que indica que a aeronave esgotou totalmente suas armas.

Zeus – Um veículo AAA de fabrico soviético.

APPENDIX

C

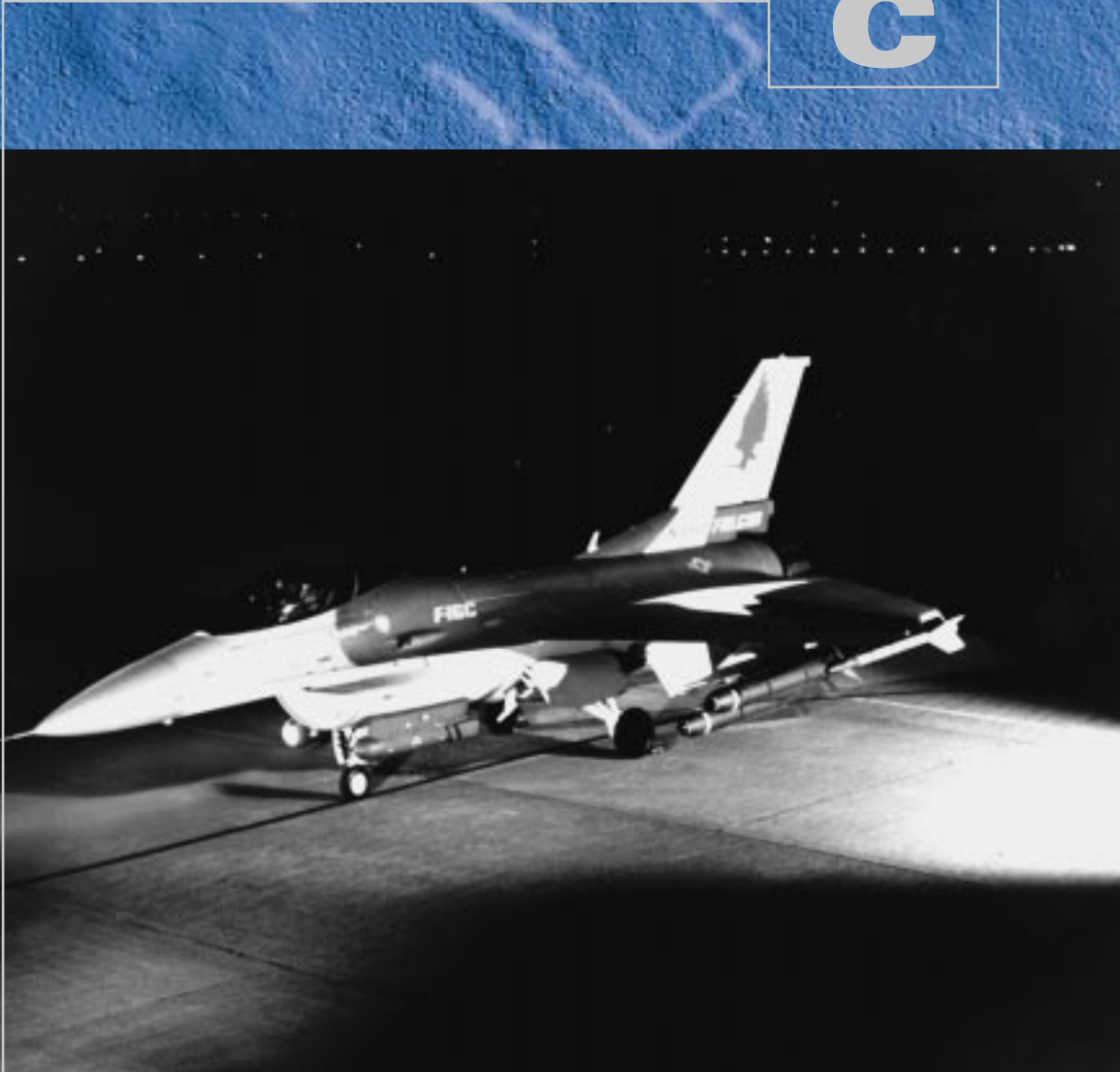

**AIRPORT
MAPS**

The maps in this appendix depict the different airports you will use in *Falcon 4.0*. Each map shows the taxiways, runway alignments, runway dimensions, which TACAN channel to use, terrain elevation and other details of the airport environments.

HOW TO USE THE MAPS

If you choose to start a mission by taxiing, ATC (Air Traffic Control) will clear you to taxi to a particular runway. Look up the airport you are operating from; they are listed in alphabetical order. Use the taxiway layout (which is colored light gray) to get to your assigned runway.

When returning from a mission, ATC will tell you which runway is in use. Refer to your airport map to plan your landing.

Note that the runway alignments are in tens of degrees ("05" is at a 50° heading). In addition, if two runways' headings are the same, the runways are differentiated with "L" for the left runway and "R" for the right. The dimensions of the runway (such as "7350 X 270") are in feet.

For more information about landing, see **Chapter 3: Landing and Navigation** and **Chapter 24: Airport Operations**.

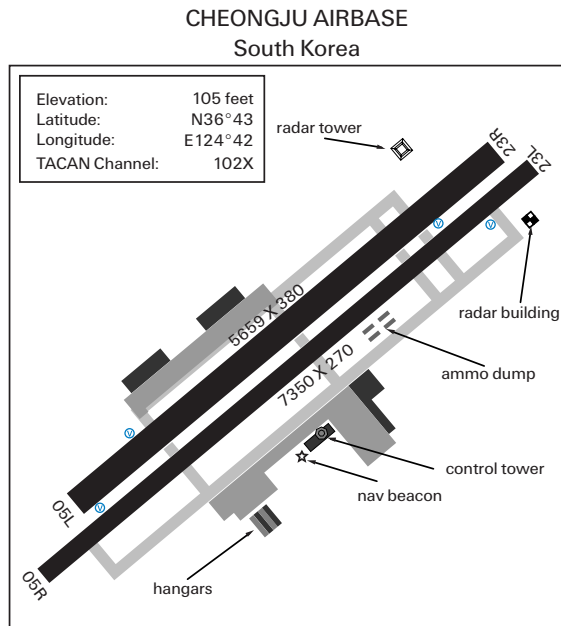

For use with *Falcon 4.0* only



CHUNGJU AIRBASE
South Korea

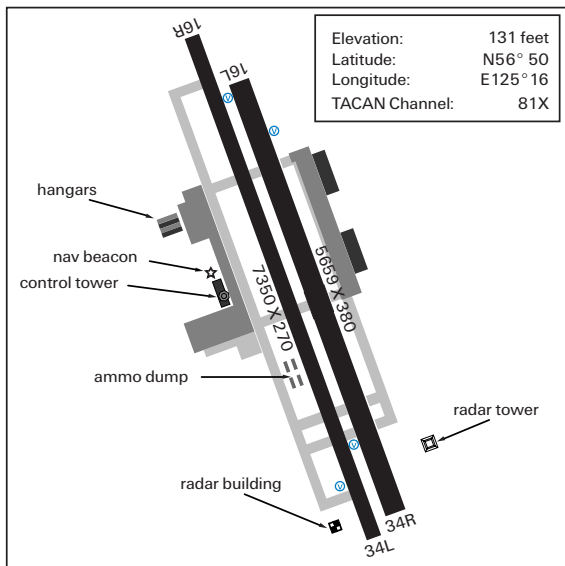

For use with *Falcon 4.0* only

GANGNEUNG AIRBASE
South Korea

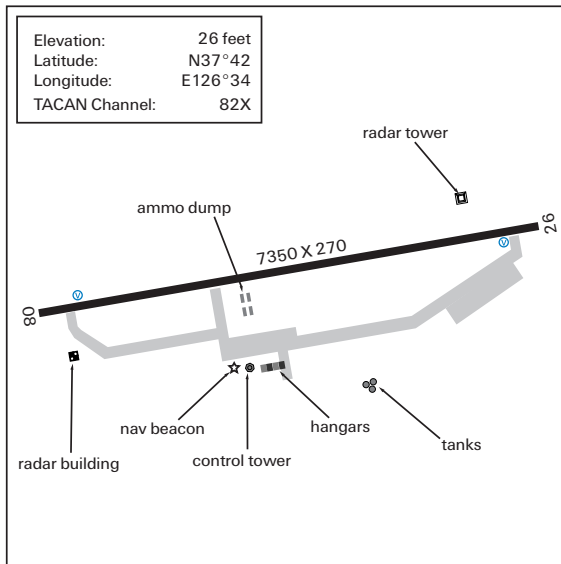

For use with *Falcon 4.0* only

HAEMI AIRBASE South Korea

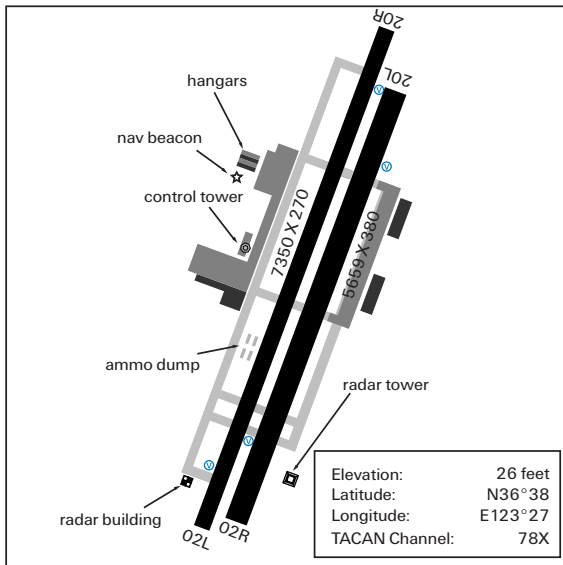

For use with *Falcon 4.0* only

JEOMCHEON AIRBASE South Korea

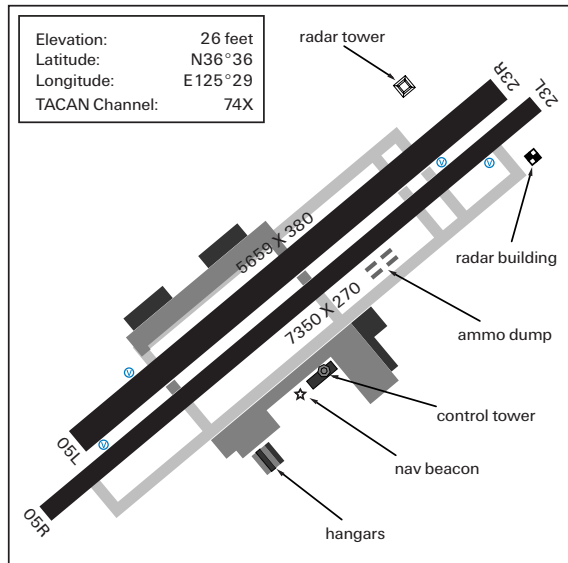

For use with *Falcon 4.0* only



KADENA AIRBASE
Japan

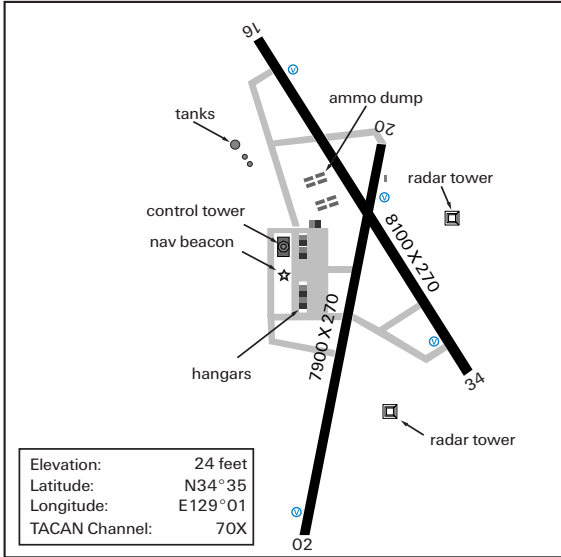

For use with *Falcon 4.0* only

KIMHAE INTERNATIONAL AIRPORT
South Korea

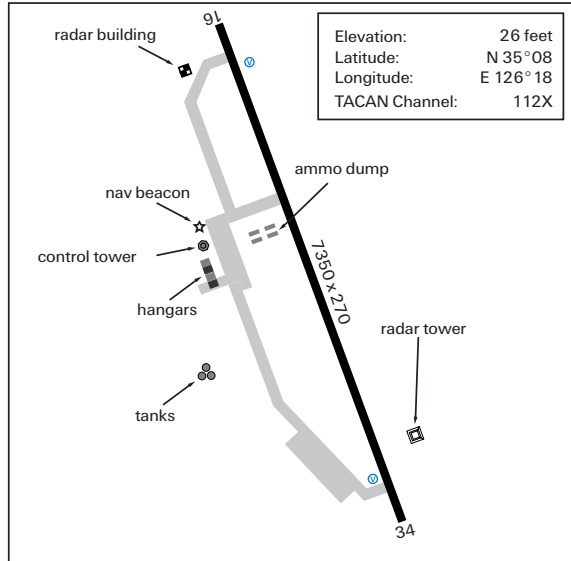

For use with *Falcon 4.0* only

KIMPO INTERNATIONAL AIRPORT South Korea

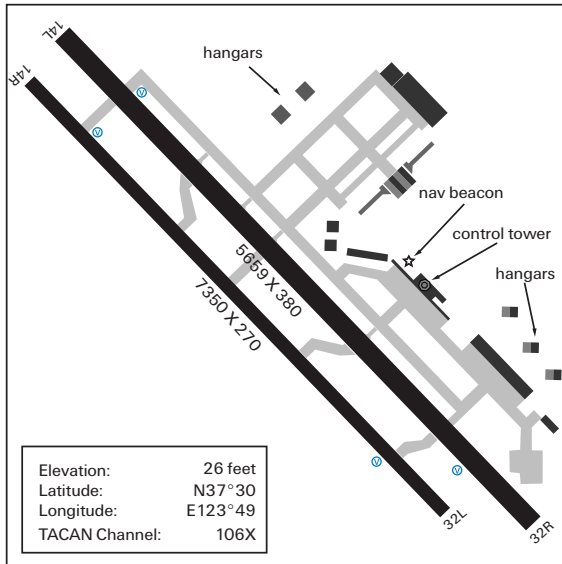

For use with *Falcon 4.0* only

KUNSAN AIRBASE South Korea

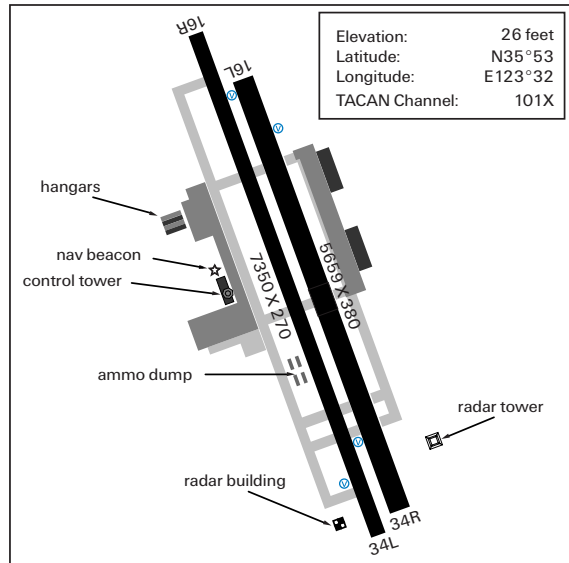

For use with *Falcon 4.0* only



KWANGJU AIRBASE
South Korea

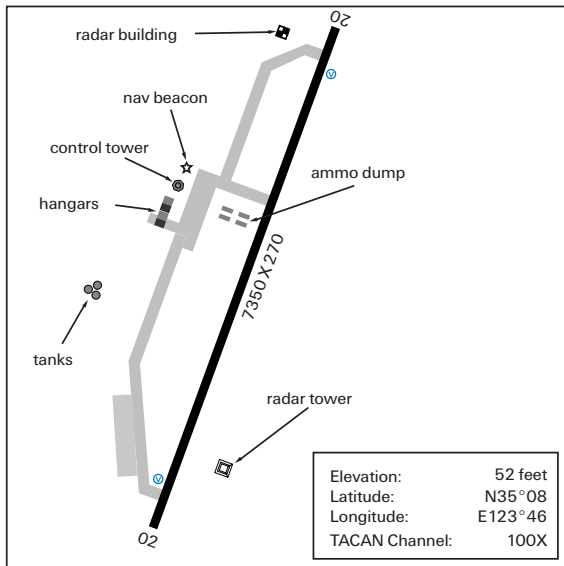

For use with *Falcon 4.0* only

MANDUMI AIRBASE
South Korea

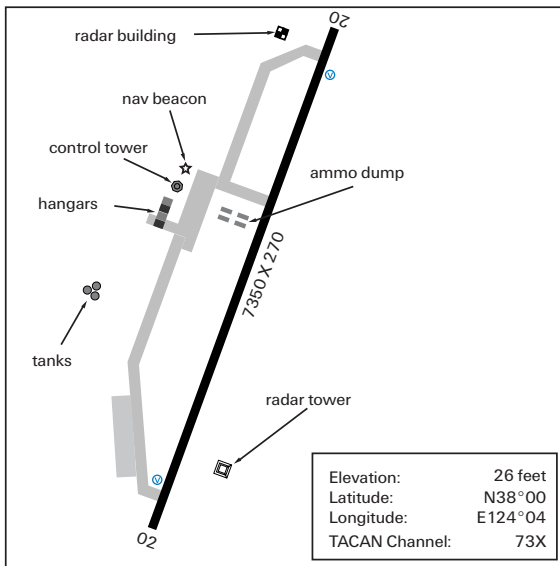

For use with *Falcon 4.0* only

OSAN AIRBASE South Korea

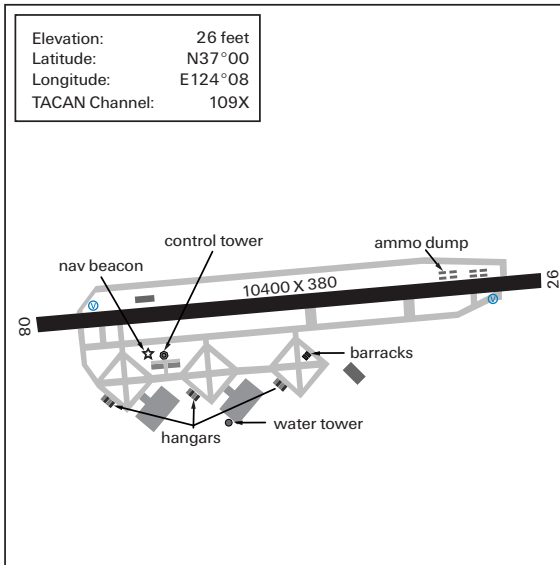

For use with *Falcon 4.0* only

POHANG AIRBASE South Korea

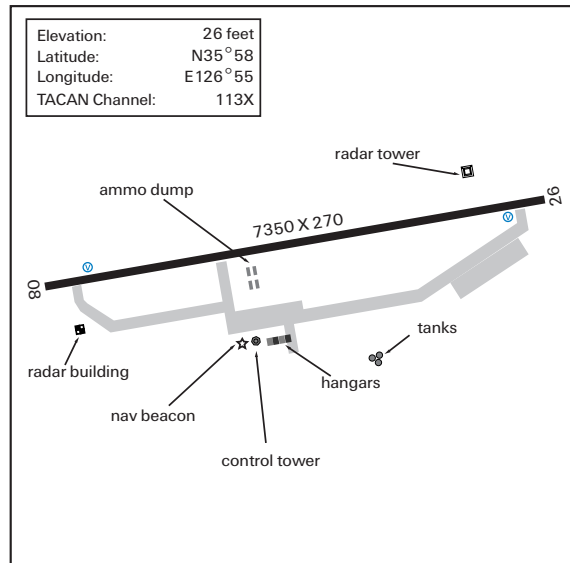

For use with *Falcon 4.0* only



PUSAN AIRBASE
South Korea

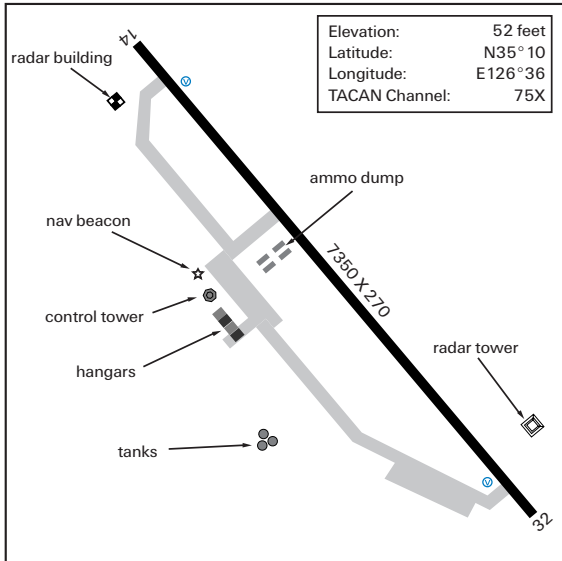

For use with *Falcon 4.0* only

PYEONGTAE AIRBASE
South Korea

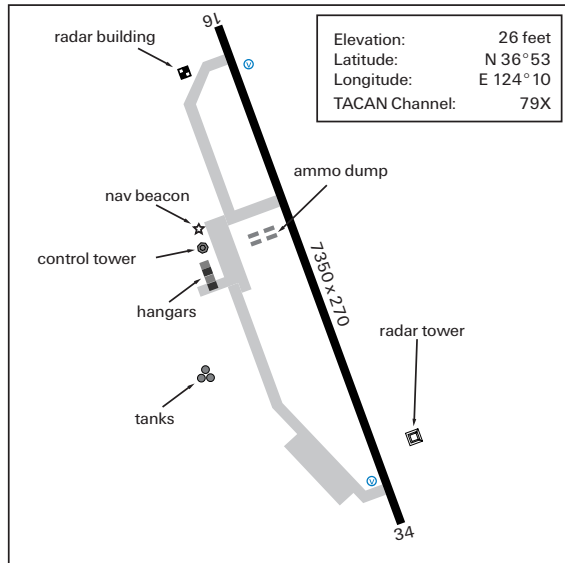

For use with *Falcon 4.0* only

SAMCHEONPO AIRBASE South Korea

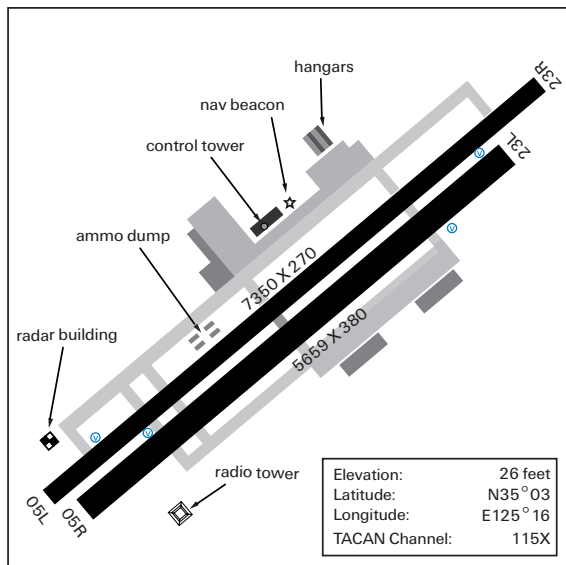

For use with *Falcon 4.0* only

SEOUL AIRBASE South Korea

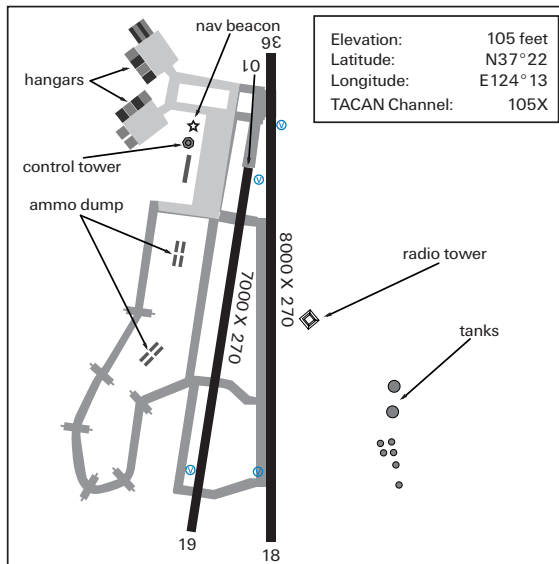

For use with *Falcon 4.0* only



SUWEON AIRBASE
South Korea

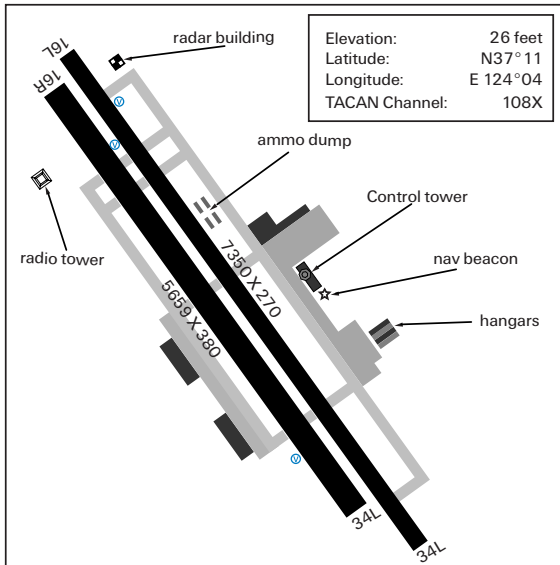

For use with *Falcon 4.0* only

TAEGU AIRBASE
United States

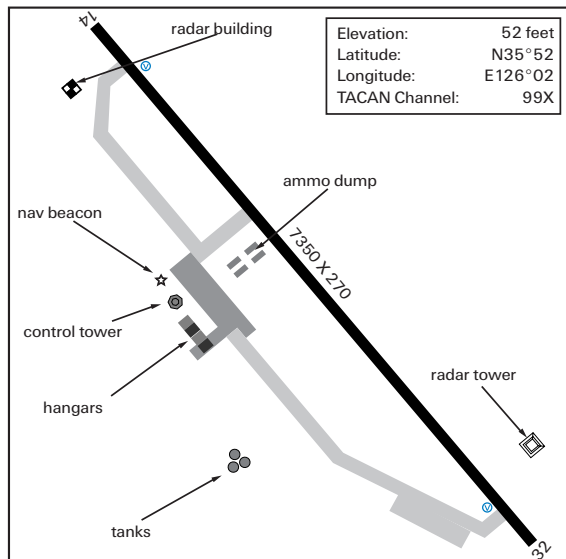

For use with *Falcon 4.0* only

YECHEON AIRBASE South Korea

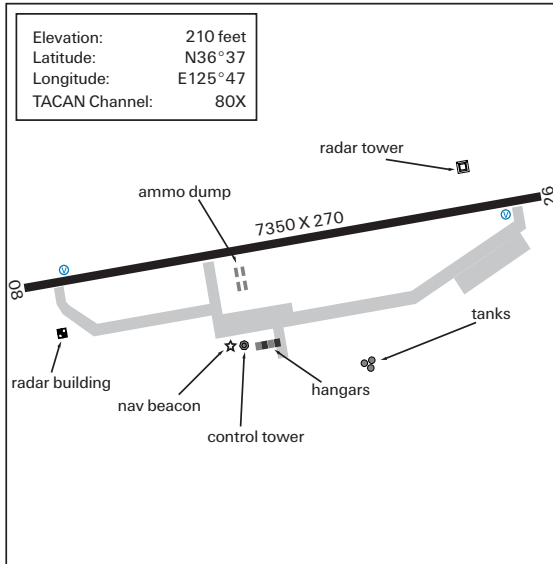

For use with *Falcon 4.0* only

APPENDIX

D



**LINEUP
CARD**

Pkg#	Callsign	Type Msn.	T/O	TOS/TOT	Land	
Target:		Objectives:				
Name:		Ordnance Load:	Target:			
C/S:	Type Msn:	#/Type A/C:	TOT:	Target:		
STP:	Description:	Time:	Dist:	Hdg:	Airspeed:	Altitude:
Threat Analysis:						
ROE:						
Alternate Airfield:				TACAN Ch:	SAE Ch:	



Pkg# 120	Callsign Falcon 1	Type Msn. OCA Strike	T/O 1020	TOS/TOT 1028:57	Land 1038	
Target: Yecheon AB		Objectives: Destroy runway & airfield facilities				
Name:		Ordnance Load:		Target:		
2Lt Joe Pilot		2xGB110, 2x2xG		Hangar		
Lt Deremiah		" "		Tower		
Lt Shank		4xCBU-89, 2X2XG		Runway		
Lt Berg		" "		" "		
C/S:	Type Msn:	#/Type A/C:	TOT:	Target:		
Fury1	SEAD	2 x F-16	1027:27	Enemy AD		
Cowboy1	OCA	4x F-16	1028:27	Rnwy/Facilities		
Falcon 1	OCA	4xF-16	1028:57	Rnwy/Facilities		
Vapor	BDA	2xF-16	1030:57	Target Area		
STP:	Description:	Time:	Dist:	Hdg:	Airspeed:	Altitude:
1	Taegu 99x	1020				
2	Push	1026	27	326	320	10000
3	Pre-IP	1027	8	328	345	22000
4	IP	1028	9	324	365	22000
5	Target	1028:57	8.4	320	365	15000
6	Egress	1031	8	044	365	20000
7	Turnpoint	1032	17	134	365	20000
8	Split	1034	30	158	320	20000
9	Landing	1041	42	175		
10	Alternate					
Threat Analysis: MiG-21 CAP expected in target area						
ROE: VID unless authorized by AWACS						
Alternate Airfield: Pohang AB				TACAN Ch: 113X	SAE Ch: 3	

A

- A-A Master Mode button, 20-3
- A-G Master Mode button, 20-3
- AAA (Anti-Aircraft Artillery), dealing with, 26-5, 27-19
- AAM page in MFD, 19-7–19-8
- AAMs (Air-to-Air Missiles). *See* air-to-air weapons
- aborting missions, 12-26
- Ace Factor statistic, 13-5
- ACM (Air Combat Mode) radar, 4-3–4-6, 4-13, 21-18, 21-22–21-24
- ACMI
 - Altitude Poles option, 14-7
 - Camera view options, 14-4–14-5
 - deleting files in, 14-8
 - Events List, 14-3
 - Focus options, 14-5–14-6
 - horizontal control, 14-6
 - Label options, 14-7
 - orbit vehicle control, 14-6
 - overview of, xvii
 - printing screen shots, 14-8
 - Radar Lock Line option, 14-7
 - recording flight data in, 14-2
 - reviewing records in, 14-2
 - setting file size in, 16-5
 - time display, 14-3–14-4
 - Track drop-down list, 14-5, 14-6
 - VCR controls, 14-3–14-4
 - Vehicle Magnification options, 14-8
 - vertical control, 14-6
 - views, manipulating, 14-6
 - views, selecting, 14-4–14-6
 - Wing Trails option, 14-8
 - Wireframe Terrain option, 14-8
 - zoom control, 14-6
- ACS (Air Combat Simulation) component, A-4
- ACT light, 17-18
- Action view, 22-8
- Add Battalion window, 11-18, 11-35–11-36
- Add Flight window, 11-18, 11-31–11-32
- Add Package window, 11-18, 11-34–11-35
- Add Squadron window, 11-19, 11-35
- ADI, 1-7, 3-11, 17-10
- aerodynamics. *See also* G force and maneuvering jets, 25-5–25-6
 - drag, 25-3–25-4
 - G force, 25-4–25-5
 - lift, 25-3, 25-7–25-8
 - munitions and, 11-28–11-29
 - stalls and, 25-6–25-8
 - thrust, 25-3
 - weight, 25-4
- AGM page in MFD, 19-8–19-13
- AGM-65 Maverick missile. *See also* air-to-ground weapons
 - DLZ display, 5-39
 - at Easy Avionics setting, 19-9
 - EXP submode and, 5-37
 - firing in boresight mode, 5-35–5-36, 5-39
 - firing in slave mode, 5-37–5-38, 5-41–5-42
 - mechanization, 5-34–5-35
 - MFD displays, 5-32–5-38
 - MFD page, 19-8–19-9
 - overview of, 5-32
 - pointing cross, 5-32, 5-33–5-34
 - tracking gates, 5-32–5-33
- AIM-7 Sparrow missile. *See also* air-to-air weapons
 - vs. AIM-120 AMRAAM missile, 4-31
 - calling up, 4-32
 - HUD display, 4-31
 - mechanization, 4-32
 - MRM HUD mode for, 18-11
 - overview of, 4-30
 - training mission using, 4-33–4-34
- AIM-9 missiles
 - DLZ bracket, 4-22–4-23
 - heat-tracking sounds of, 4-23
 - HUD displays, 4-22–4-25
 - HUD mode for, 18-11–18-13
 - in Dogfight mode, 4-24
 - in stand-alone mode, 4-24–4-25
 - mechanization, 4-22–4-24
 - overview of, 4-21–4-25
 - training mission using, 4-25–4-27



- AIM-120 AMRAAM missile
 - vs. AIM-7 Sparrow missile, 4-31
 - calling up, 4-29
 - DLZ bracket, 4-28
 - HUD display, 4-28, 4-28-4-29
 - mechanization, 4-28-4-29
 - MRM HUD mode for, 18-9-18-11
 - overview of, 4-27
 - training mission using, 4-29-4-30
- aimed fire tactic, 26-5
- Air Combat Simulation component, A-4
- Air Defense options in Instant Action, 9-3
- Air Force Cross medal, 13-7-13-8
- Air Force Longevity Service Award, 13-7-13-8
- Air Medal, 13-7-13-8
- Air Tasking Order (ATO) tool, 12-18, 11-22-11-23
- air-to-air padlocking priorities, 22-6-22-7
- air-to-air radar modes. *See also* radar; RWS
 - ACM master mode, 4-3-4-6, 4-13, 21-18, 21-22-21-24
 - azimuth scan, 21-16
 - B-scope display, 4-6-4-7, 21-11
 - bar scans, 21-16
 - Boresight mode, 4-3-4-4, 21-23
 - bullseye readouts, 21-14-21-15
 - controlling, 21-10-21-11
 - combining, 21-17-21-18
 - display characteristics, 21-11-21-17
 - Dogfight mode, 21-18
 - Easy option for, 21-3-21-4
 - HUD Scan mode (30X20), 4-5, 21-22-21-23
 - intercept steering cue, 21-13
 - jamming, 21-25
 - MFD display, 4-2
 - Missile Override mode, 21-18
 - NCTR system, 21-13
 - OSB labels and functions, 21-13-21-17
 - override modes, 21-18
 - overview of, 4-2-4-3, 21-9-21-10
 - radar cursors, 21-12
 - radar returns, 21-11
 - range readouts, 21-17
 - reacquisition elevation symbol, 21-13
 - Realistic option for, 21-9-21-24
 - RWS master mode, 4-7-4-11, 21-17-21-19
 - RWS-SAM mode, 21-19-21-20
 - SAM mode, 21-18
 - Simplified option for, 21-6-21-8
 - Sleuable mode, 4-6, 21-23-21-24
 - steerpoint symbol, 21-12
 - STT mode, 21-18, 21-24
 - training mission using, 4-12-4-14
 - TWS master mode, 4-11, 21-17, 21-20-21-21
 - Vertical Scan mode (10X60), 4-4-4-5, 21-23
 - VS master mode, 4-12, 21-17, 21-21-21-22
- air-to-air refueling. *See also* fuel closing in on tankers, 6-4-6-5 finding tankers, 6-2-6-3 getting gas, 6-5-6-7 options, 16-4 overview of, 6-7-6-8 tanker director lights in, 6-5-6-6
- air-to-air weapons. *See also* AIM missiles; missile threats; 20mm cannon
 - AIM-7 Sparrow missile, 4-30-4-34, 18-11
 - AIM-9 missiles, 4-21-4-27, 18-11-18-13
 - AIM-120 AMRAAM missile, 4-27-4-30, 18-9-18-11
 - heat-seeking missiles. *See* AIM-9 missiles
 - HUD modes for missiles, 18-8-18-13
 - HUD modes for guns, 18-14-18-17
 - infrared-guided missiles, 7-2, 7-5, 26-2, 26-4
 - medium-range missiles (MRMs), 18-8-18-11
 - MFD page for guns, 19-15-19-16
 - Munitions tool, 11-27-11-30
 - radar-guided missiles, 7-3-7-4, 7-6. *See also* AIM-7 and AIM-120 missiles
 - radar modes for, 4-2-4-14
 - short-range missiles (SRMs), 18-11-18-13
 - 20mm cannon, 4-14-4-21
- air-to-ground padlocking priorities, 22-7

air-to-ground radar modes. *See also* radar;
RWR; RWS

artificial horizon, 21-26

azimuth scan, 21-29

BARO mode, 5-6

characteristics of, 21-26–21-27

CNTL mode, 21-28

cursors, 5-3–5-4

CZ mode, 5-6, 21-28

DBS1 mode, 5-6, 5-9–5-10, 21-28

DBS2 mode, 5-6, 5-9–5-10, 21-28

DCLT function, 21-29

display, 5-2–5-3

Easy option for, 21-4–21-5

EXP mode, 5-5–5-6, 5-9–5-10

FZ mode, 5-6, 21-28

GM master mode, 5-2, 5-5, 5-7–5-8,
21-9, 21-30

GMT master mode, 5-2, 5-5, 5-9,
21-31–21-32

jamming, 21-25

MAN mode, 5-5

master modes, 5-2, 5-5, 21-25

NRM mode, 5-5

OSB labels and functions, 5-5–5-6,
21-27–21-29

overview of, 5-2

OVRD mode, 5-6, 21-28

quarter mile scale reference, 21-31

radar cursors, 21-26

radar gain controls, 21-30

radar returns, 21-26

range scale, 5-3, 21-29

Realistic option for, 21-25–21-32

SEA master mode, 5-2, 5-5, 21-32

Simplified option for, 21-9

SP mode, 5-6, 5-11, 21-27, 21-28

steerpoint symbol, 21-26

STP mode, 5-6, 5-10–5-11, 21-29

targets, 5-7

air-to-ground weapons. *See also* AGM-65
Maverick; HARMs; LGBs

AGM-65 Maverick missile, 5-32–5-42,
18-26–18-29

AGM-88A HARM missile, 18-31–18-33

bomb dropping options, 18-23

bombs, types of, 18-24–18-25

GBUs (Guided Bomb Units), 5-43,
18-29–18-31

guns, HUD mode for, 18-33

HARM missiles, 5-52–5-58

heat-seeking missiles. *See* AGM-65
Mavericks

HUD modes for, 18-18–18-25

HUD submodes for, 18-27–18-31

laser-guided bombs, 5-42–5-52

MFD page for bombs and rockets,
19-13–19-14

MFD page for guns, 19-15

Munitions tool, 11-27–11-30

radar modes for, 5-2–5-11

rockets, 5-30–5-31, 18-25

20mm cannon, 5-28–5-30

unguided bombs in CCIP mode, 5-17–5-23

unguided bombs in CCRP mode, 5-12–5-17

unguided bombs in DTOS mode, 5-23–5-27

aircraft. *See also* aerodynamics

aircraft G, 2-2

balancing munitions in, 11-28–11-29

effect of gravity on, 2-13

exterior lights toggle switch, 17-20

statistics, 11-28–11-29, 12-23

viewing data on, 15-2–15-4

aircraft handling. *See* flying basics

airport maps, C-2–C-12

airport operations

approach procedures, 24-3–24-5

departures, 24-2–24-3

emergencies, 24-6

ground operations, 24-2

landings, 24-6

recoveries, 24-3

airspeed

Airspeed/Mach indicator, 17-9

controlling, 8-4–8-5

corner airspeed, 2-2–2-4, 8-4

indicator on front console, 1-8

scale on HUD, 1-6, 18-2

timing caret, 18-8

allied resources, viewing data on, 15-2–15-4

ALOW button, 20-5

altimeter, 1-8, 17-10



altitude

- AL (altitude low) indicator, 18-3
- ALT warning light, 17-6
- Altitude Poles option, 14-7
- “ALTITUDE–ALTITUDE” voice message, 17-14

options switch, 17-17

scales on HUD, 1-6–1-7, 18-3

Ambush CAP missions, 11-32, 26-7

ambush tactics of enemies, 26-4, 26-7

angle-off, 8-3

Anti-Ship missions, 11-33

AOA (Angle of Attack)

indexer, 17-4

indicator on front console, 1-8, 17-10

AR Status/NWS indicator, 17-5

Art of the Kill (Bonanni), 1-2

artificial horizon, 21-8, 21-11, 21-26

ascents, 1-11

aspect angle, 8-3, 21-7

ATO (Air Tasking Order) tool, 12-18,

11-22–11-23

attacking enemies. *See* BFM; mission

execution; mission planning

Attitude Director Indicator (ADI), 1-7, 3-11,

17-10

audio. *See* sound features

Auto Save feature in Campaign, 12-25

Auto/Man chaff/flare switch, 17-24

autopilot, 16-3, 17-15

auxiliary comm panel, 17-20

AVIONICS caution light, 17-22

Avionics options, 16-3

AVTR switch, 14-2, 17-23

AWACS radio commands, 23-2–23-4

azimuth sweep, 4-8, 21-16, 21-29

B

B-scope radar display, 4-6–4-7, 21-11

BA (Burst Altitude), 19-14

bar scans, radar, 21-16

BARCAP missions, 11-32

BARO radar mode, 5-6

barrage fire tactic, 26-5

base leg, 3-9

Battalion Status window, 11-36

BDA missions, 11-33

beam intercepts, 26-9

BFM (Basic Fighter Maneuvers). *See also*

defensive BFM; head-on

BFM; offensive BFM

airspeed control in, 8-4–8-5

biggest factors in, 8-8

corner airspeed and, 8-4

defensive BFM, 8-8–8-14

energy and, 8-5

head-on BFM, 8-14–8-20

offensive BFM, 8-2–8-8

overview of, 8-2–8-3

turn rate and radius and, 8-4

“BINGO–BINGO” voice message, 17-14

blackouts, pilot, 25-4–25-5

blinking tactic, 26-4

bombs. *See* air-to-ground weapons

Bonanni, Pete “Boomer,” A-2, 1-2, 11-3,

27-2

boresight cross. *See* gun cross

bracket intercepts, 26-8–26-9

Break-X indicator, 18-6

Briefing window, 11-24

brightness control switch, 17-17

boresight (BSGT) mode

dropping LGBs in, 5-44–5-45,

5-50–5-51

firing Mavericks in, 5-35–5-36, 5-39

in HUD, 18-27–18-30

of radar, 4-3–4-4, 21-23

BSU/BLU bombs, 18-24

buddy launching tactic, 26-5

bullseye readouts, 19-5, 21-14–21-15

“burn through,” 21-25

BVR intercept tactics, 26-7–26-10

C

CABIN PRESS caution light, 17-22

Campaign. *See also* mission

planning; Tactical Engagement

aborting missions, 12-26

adjusting clock, 12-12–12-13, 12-24

Air Tasking Order window, 12-18

- Auto Save feature, 12-25
- Briefing window, 12-16
- Campaign Priorities button, 12-14
- creating campaigns, 12-7–12-20
- Debriefing window, 12-26
- dying in campaigns, 12-26
- ending missions, 12-26
- entering missions, 12-24–12-25
- Event Map, 12-11, 12-12
- Fit Flight Plan button, 12-15
- Flight Plan window, 12-21–12-22
- Force Levels window, 12-19
- Help button, 12-14
- Intel screen, 12-17–12-20
- JSTARS Replay window, 12-19
- jumping into, 12-3–12-7
- loading saved campaigns, 12-9
- Maximize button, 12-14
- mission planning tools, 12-20–12-24
- Mission Schedule screen, 12-7, 12-10–12-16
- modifying steerpoints, 12-20–12-21
- Munitions window, 12-22–12-24
- News Reports, 12-12
- Order of Battle window, 12-18
- overview of, xvii, 12-2, A-4
- Planning Map, 12-11, 12-13–12-15, 12-20
- Preliminary Campaign screen, 12-7–12-10
- saving campaigns, 12-6–12-7, 12-25
- Scenario Overview, 12-10
- Scramble mission, 12-25
- selecting aircraft, 12-12
- selecting campaign scenarios, 12-8–12-9
- selecting missions, 12-11–12-12
- Sierra Hotel window, 12-20
- Squadron window, 12-19–12-20
- steerpoint modification menu, 12-20
- vs. Tactical Engagement, 11-3
- takeoff options, 12-24–12-25
- Theater Map, 12-9
- winning campaigns, 12-26
- zoom controls, 12-14
- Canopy Cues options, 16-8
- Canopy Reflections feature, 22-10
- CAP (Combat Air Patrol) missions, 26-6–26-7
- CAP (Critical Action Procedures) sheets, 2-23
- CAS (Close Air Support) missions, 11-33
- caution lights. *See also* warning lights
 - on front console, 17-5–17-6
 - Master Caution light, 17-5
 - vs. warning lights, 17-6
 - on right console, 17-21–17-22
- caution voice messages, 17-13, 18-6
- CBU bombs, 18-25
- CCIP bombing mode
 - bombing options in, 5-23
 - bombing triangle, 5-17–5-18
 - delay cues in, CCRP and, 5-19–5-20
 - dropping bombs in, 5-17–5-23
 - HUD symbology in, 5-18–5-19, 18-22
 - overview of, 5-17, 18-22–18-23
- CCRP bombing mode
 - air-to-ground radar and, 5-4
 - bombing triangle, 5-12
 - dropping unguided bombs in, 5-12–5-17
 - for LGBs, 5-47
 - HUD symbology in, 5-13–5-14, 18-19–18-21
 - overview of, 5-12, 18-19
- CDI (Course Deviation Indicator), 3-8
- chaff control panel, 17-23–17-24
- champagne intercepts, 26-8–26-9
- Chase view, 14-4, 22-9
- Check in and out commands, 23-3
- clock, 17-23
- CNI switch, 17-20, 17-24
- CNTL radar mode, 21-28
- cockpit views, 22-2–22-4
- color schemes for labels, 22-9
- COM 1 and 2 Override buttons, 20-3–20-4
- combat techniques. *See* BFM; missile threats; mission execution
- Combined Radar Mode (CRM), 21-17–21-18
- Comm panel, auxiliary, 17-20
- compass, magnetic, 17-21
- configuration options. *See* Setup
- consent to release, 18-20
- consoles
 - ADI indicator, 1-7, 17-10
 - airspeed indicator, 1-8
 - Airspeed/Mach indicator, 17-9
 - altimeter, 1-8, 17-10



altitude switch, 17-17
 AOA indexer, 17-4
 AOA indicator, 1-8, 17-10
 AR Status/NWS indicator, 17-5
 autopilot switch, 17-15
 brightness control switch, 17-17
 caution lights panel, 17-21–17-22
 chaff and flare controls, 17-23–17-24
 clock, 17-23
 comm panel, auxiliary, 17-20
 cursor and, 17-2
 DED data switch, 17-17
 ECM switch, 17-18
 ejection handle, 17-13
 emergency stores jettison button, 17-15
 FPM switch, 17-17
 front console, 1-7–1-9, 17-3–17-14
 fuel flow indicator, 17-8
 fuel quantity indicator, 17-21
 horn silencer button, 17-16
 HSI indicator, 1-8, 17-10–17-12
 HUD display, 17-3
 HUD control panel, 17-16–17-17
 ICP panel, 17-8
 IFF button, 17-6
 kneeboard, 17-13
 landing gear handle, 17-16
 landing gear status lights, 17-15
 left auxiliary console, 17-15–17-20
 left eyebrow warning lights, 17-6
 magnetic compass, 17-21
 Master Caution light, 17-5
 MFD displays, 17-9
 navigation system, 17-24–17-26
 nozzle position indicator, 17-9
 oil pressure indicator, 17-9
 radio channel selector, 17-18–17-19
 radio function knob, 17-20
 right auxiliary console, 17-21
 right eyebrow warning lights, 17-8–17-9
 RPM indicator, 1-9, 17-9
 speed brakes position indicator, 17-16
 switching between, 17-2
 TL/CFG light, 17-8–17-9

Threat Warning System and,
 17-6–17-8, 17-18
 velocity switch, 17-17
 Voice Message System and, 17-13
 VVI indicator, 17-11
 Controllers setup screen, 16-11–16-14
 corner airspeed, 2-3, 8-4
 Course Deviation Indicator (CDI), 3-8
 CRM (Combined Radar Mode),
 21-17–21-18
 CRS (Course) set knob, 3-8
 CRUS button, 20-11
 cursors
 A-A and A-G ghost cursors, 19-5
 radar cursors, 21-12, 21-26
 CZ (Cursor Zero) radar mode, 5-6, 21-28

D

DBS1 and DBS2 radar modes, 5-6,
 5-9–5-10, 21-28
 DCA missions, 11-32
 DCLT (Declutter) radar function, 21-29
 Debriefing window, 9-4, 12-26
 Declare command, 23-2–23-3
 DED (Data Entry Display). *See also* ICP
 data switch, 17-17
 display panel, 20-2
 overview of, 17-8
 deep stalls
 defined, 2-20
 overview of, 25-6–25-8
 recovering from, 2-23–2-24
 Deep Strike missions, 11-33
 Default graphics button, 16-9
 defensive BFM. *See also* BFM
 against gun attacks, 8-12–8-14
 against missile attacks, 8-13–8-14
 gun exception to, 8-10
 missile exception to, 8-10
 overview of, 8-8–8-10
 lift vector and, 8-8
 training mission using, 8-11–8-14
 turning at corner airspeed, 8-10
 delay cues in CCIP, 5-19–5-20
 deleting ACMI files, 14-8

- departures, 2-20
- descents, 1-11
- Disable Clouds option, 16-5
- Distinguished Flying Cross medal, 13-7–13-8
- Dive Toss. *See* DTOS
- DILZ (Dynamic Launch Zone) display, 18-10
- Dogfight (DGFT) mode
 - AIM-9 missiles in, 4-24
 - HUD display, 18-17–18-18
 - of radar, 21-18
- Dogfights
 - enemy tactics in, 26-10
 - exiting, 10-6
 - Furball dogfights, 10-2
 - Match Play dogfights, 10-4–10-5
 - overview of, xvi
 - reviewing, 10-6
 - saving setups for, 10-6
 - selecting map areas and times for, 10-5
 - setting options for, 10-5–10-6
 - setting up, 10-2
 - starting, 10-2, 10-6
 - Team Furball dogfights, 10-4
- drag
 - munitions and, 11-28–11-29
 - drag index, 2-4
 - overview of, 25-3–25-4
- drag intercepts, 26-9
- DTOS (Dive Toss) bombing mode, 5-23–5-27
 - bombing triangle, 5-24
 - dropping unguided bombs in, 5-23–5-27
 - HUD symbology, 5-24–5-25, 18-21–18-22
 - overview of, 5-23, 5-25, 18-21
 - when to use, 5-23
- DUAL/CAN warning light, 17-8
- dying in campaigns, 12-26

E

- Easy Avionics setting
 - HARMs at, 19-12
 - LGBs at, 19-11
 - Mavericks at, 19-9
 - overview of, 18-36
- Easy radar
 - in air-to-air mode, 21-3–21-4
 - in air-to-ground mode, 21-4–21-5
 - overview of, 21-2
- ECM (Electronic Countermeasures)
 - caution light, 17-22
 - toggle switch, 17-18
- EEGS (Enhanced Envelope Gun Sight)
 - funnel, 4-18, 18-15
 - HUD mode, 18-14–18-15
 - overview of, 4-18–4-19
- EFOV (Extended Field of View), 16-4, 22-7
- egress phase in missions, 27-21–27-22
- ejection handle, 17-13
- Element radio commands, 23-4
- emergency landings, 3-17, 24-6
- emergency stores jettison button, 17-15
- ending missions, 9-4, 12-26
- enemy opposition, adding, 11-9–11-10
- enemy assets, viewing data on, 15-2–15-4
- enemy tactics
 - Ambush CAP missions, 26-7
 - ambushes by SAMs, 26-4
 - beam intercepts, 26-9
 - blinking, 26-4
 - bracket intercepts, 26-8–26-9
 - buddy launching, 26-5
 - BVR intercepts, 26-7–26-10
 - CAP missions, 26-6–26-7
 - connectivity in, 26-2
 - drag intercepts, 26-9
 - escort missions, 26-6
 - in dogfights, 26-10
 - ladder intercepts, 26-9
 - of AAA guns, 26-5
 - of fighter planes, 26-6–26-10
 - of SAMs, 26-3–26-5
 - redundancy in, 26-3
 - single side offset intercepts, 26-8
 - split plane maneuvering, 26-10
 - sweep missions, 26-7
 - synchronization in, 26-3
 - trail intercepts, 26-9



enemy threats. *See also* missile threats;
TWS
checking target area for, 27-10–27-11
dealing with AAA, 27-19
dealing with enemy planes, 27-16–27-17
reaction techniques for, 27-15

Enemy view, 22-8

engagement criteria, 27-22

engagements, 11-16, 11-38. *See also*
Campaign; missions; Tactical
Engagement

ENGINE FAULT caution light, 17-22

ENTR button, 20-12

escort missions, 11-32, 26-6

ETA (Estimated Time of Arrival) readouts,
18-8

ETE (Estimated Time Enroute) readouts,
18-8

Event Map, 12-11, 12-12

exiting missions, 11-40

EXP (Expand) radar mode, 5-5–5-6,
5-9–5-10, 5-37

Extended Field of View (EFOV), 16-4, 22-7

exterior aircraft lights switch, 17-20

eyebrow warning lights, 17-6, 17-8–17-9

F

F-ACK button, 20-5–20-10

FAC (Forward Air Control) missions, 11-33
Falcon 4.0
Air Combat Simulation component, A-4
beyond visual bubbles in, A-6
Campaign component, xvii, A-4
compromises and, A-3
creating fighter pilot attitude in, A-2–A-3
documentation, xvii–xviii
F-16A vs. F-16C and, A-7–A-8
flight model, A-4
vs. flying real F-16s, A-2, A-8
GLOC feature, A-7
goals, A-4, A-8
graphics, A-5
“horizon effect” and, A-6
HUD, A-6
hyper-action in, A-6
as multiplayer game, A-7
overview of, xvi–xviii
pilot overload and, A-5
radar, A-6
sound effects, A-6
Tactical Engagement feature, xvi, A-7
terrain system, A-5
user interface, A-7
Web site, xviii

FCR (Fire Control Radar) system, 19-6, 21-9

FFARs (Folded-Fin Aerial Rockets), 18-25

FIRE/ENG warning light, 17-8

Fit Flight Plan button, 11-19, 12-15

flare control panel, 17-23–17-24

flare landing maneuver, 3-6

FLCS (Flight Control System), 2-19–2-20

Flight Model options, 16-3

Flight Path Marker (FPM), 1-5–1-6, 17-17,
18-3–18-4

flight paths of missiles, 7-4–7-5

Flight Planner window, 11-25–11-27,
12-21–12-22, 27-3, 27-5

Flight radio commands. *See also* radio
commands
Combat Management page, 23-5–23-7
Formation Management page, 23-8
Identification Management page, 23-11
Mission Management page, 23-7–23-8

flight, defined, 11-15

FLOT (Forward Line of Troops), 19-5,
27-13–27-15

FLT CONT SYS caution light, 17-21

Flyby view, 22-9

flying basics. *See also* turns; landings
climbs, 1-11
cockpit instruments and, 1-7–1-9
combining turns and climbs, 1-11
descents, 1-11
HART maneuvers, 1-12–1-13
the HUD and, 1-5–1-6
landings, 24-3–24-6
low altitude level turns, 1-11
staying level, 1-10
switching views, 1-9
takeoffs, 1-13–1-16
turns, 1-10

"flying the caret," 13
 Force Levels window, 12-19
 form drag, 25-3
 Formation Management commands, 23-8
 FPM (Flight Path Marker), 1-5-1-6, 17-17,
 18-3-18-4
 Free view, 14-5
 Freeze (the game) mode, 1-4
 Freeze (FZ) radar mode, 5-6, 21-28
 Friendly Ground Unit view, 22-9
 Friendly view, 22-9
 fuel. *See also* air-to-air refueling
 flow indicator, 17-8
 FUEL LOW caution light, 17-21-17-26
 fuel low messages, 18-6
 quantity indicator, 17-21
 funnel, EEGS, 4-18, 18-15
 Furball dogfights, 10-3-10-4
 fuselage reference line, 25-7
 FZ (Freeze) radar mode, 5-6, 21-28

G

G force. *See also* aerodynamics
 aircraft G, 2-2
 and maneuvering jets, 25-5-25-6
 blackouts and, 25-4-25-5
 cockpit G, 2-13
 defined, 25-4
 indicator, 1-6, 18-4
 lift vector and, 25-5-25-6
 max G force indicator, 18-4
 radial G (GR), 2-13
 redouts and, 25-5
 Galland, Adolf, A-2
 GBUs (Guided Bomb Units). *See also* air-to-
 ground weapons
 HUD modes for, 18-29-18-31
 vs. LGBs, 5-43
 GLOC feature, A-7
 GM (Ground Map) radar mode, 5-2, 5-5,
 5-7-5-8, 21-9-21-10, 21-30-21-31
 GMT (Ground Moving Target) radar mode,
 5-2, 5-5, 5-9, 21-31-21-32
 Gouraud Shading option, 16-7
 GPS (Global Positioning System), 3-18

Graphics options, 16-6-16-9
 gravity, vertical turns and, 2-13
 guided missiles/bombs, 18-18. *See also* air-to-
 air weapons; air-to-ground weapons
 gun cross on HUD, 1-6, 4-15-4-16, 18-6
 gun sights
 calling up, 4-17
 EEGS gun sight, 4-18-4-19, 18-14-18-15
 HUD gun cross and, 4-15-4-16
 LCOS gun sight, 4-17-4-18, 18-15-18-17
 "leading the target" and, 4-15-4-16
 MRGS (Multiple Reference Gun Sight),
 18-15
 plane of motion and, 4-16-4-17
 range and, 4-16
 Snapshot line gun sight, 4-19, 18-17
 theory, 4-15-4-17
 guns, defensive BFM against, 8-12. *See also*
 air-to-air weapons; air-to-ground
 weapons; 20mm cannon

H

Handley, Phil "Hands," A-2
 Handoff button, 17-7
 HARMs (High-Speed Anti-Radiation Missiles).
 See also HTS
 AGM-88A HARMs, 18-31-18-33
 at Easy Avionics setting, 19-12
 HTS and, 5-52-5-53
 HUD display, 5-56-5-57
 HUD mode for, 18-31-18-33
 training mission using, 5-55-5-58
 HART maneuvers, 1-12-1-13
 HAVCAP missions, 11-32
 Haze option, 16-7
 head-on BFM. *See also* BFM
 level turn option, 8-16
 mistakes in, 8-15
 one-circle fights, 8-18-8-19
 options in, 8-14-8-17
 overview of, 8-14
 slice option, 8-15-8-16
 training mission using, 8-19-8-20
 two-circle fights, 8-18-8-19
 vertical fight option, 8-16-8-17



- heading indicator, 1-6, 18-3
- heading readout for targets, 21-7
- heat-seeking missiles. *See* AGM-65
 - Maverick missile; AIM-9 missiles
- Help in Campaign, 12-14
- Help in Tactical Engagement, 11-18, 11-22
- HOOK caution light, 17-22
- horizon, artificial, 21-8, 21-11, 21-26
- "horizon effect," A-6
- horizontal control, 14-6
- horizontal pitch bar, 3-12
- horn silencer button, 17-16
- Horner, Chuck, 12-2
- HSD (Horizontal Situation Display)
 - A-A and A-G ghost cursors, 19-5
 - FLOT line, 19-5
 - navigation route, 19-5
 - OSB labels, 19-4
 - overview of, 3-22, 19-3–19-18
 - ownership indicator, 19-4
 - range rings, 19-5
 - range scale, 19-4
- HSI (Horizontal Situation Indicator)
 - CDI indicator, 3-8
 - CRS set knob, 3-8
 - ILS data in, 3-8–3-9
 - in instrument landings, 3-7–3-9
 - overview of, 1-8, 3-21
 - range window, 3-8
- HTS (HARM Targeting System). *See also*
 - HARMs
 - HUD mode, 18-31–18-33
 - mechanization, 5-53
 - MFD display, 5-53–5-55
 - MFD page, 19-11–19-12
 - overview of, 5-52–5-53
- HUD (Head-Up Display)
 - for AGM-65 missiles, 18-26–18-29
 - for AIM-7 missiles, 4-31
 - for AIM-9 missiles, 4-22–4-25
 - for AIM-120 missiles, 4-28–4-29
 - for air-to-air guns, 18-14–18-17
 - for air-to-air missiles, 18-8–18-13
 - for air-to-ground weapons, 5-56–5-57, 18-18–18-33
 - airspeed indicator, 1-6, 18-2
 - altitude indicators, 1-6–1-7, 18-3
 - Break-X indicator, 18-6
 - BSGT submode, 18-27–18-30
 - CCIP mode, 5-18–5-19, 18-22–18-23
 - CCRP submode, 5-13–5-14, 5-47, 18-19–18-21
 - control options, 1-7, 18-36
 - control panel, 17-16–17-17
 - DGFT mode, 18-17–18-18
 - DTOS mode, 5-24–5-25, 18-21–18-22
 - EEGS mode, 18-14–18-15
 - flight path marker, 1-5–1-6, 18-3–18-4
 - fuel low messages, 18-6
 - G force indicator, 1-6, 18-4
 - for guided bombs, 18-29–18-31
 - gun cross, 1-6, 18-6
 - for HARM missiles, 5-56–5-57
 - heading indicator, 1-6, 18-3
 - HTS mode, 18-32–18-33
 - HUD mode indicator, 18-4–18-5
 - HUD page in MFD, 19-18
 - in ILS mode, 18-35
 - in LCOS mode, 18-15–18-17
 - in LGB mode, 5-47, 18-29
 - Mach indicator, 18-5
 - max G force indicator, 18-4
 - in MRM mode, 18-8–18-11
 - in MSL mode, 18-18
 - in NAV mode, 18-7–18-8
 - overview of, 17-3, 18-2
 - pitch ladder, 1-6, 18-5
 - in RCKT mode, 5-30, 18-25
 - in RPOD mode, 18-34
 - in SLAVE submode, 5-37, 18-28–18-29, 18-31
 - in SNAP submode, 18-17
 - SOI (Sensor of Interest), 18-6
 - in SRM mode, 18-11–18-13
 - steerpoint marker, 18-5
 - steerpoint readouts, 3-19, 18-8
 - steerpoint navigation symbol, 3-20, 18-7
 - STRF mode, 5-28, 18-33
 - tadpole navigation marker, 3-21, 18-7
- HUD Only view, 22-2

HUD Scan radar mode, 4-5, 21-22–21-23
 HYD/OIL warning light, 17-8

I

ICP (Integrated Control Panel)
 A-A button, 20-3
 A-G button, 20-3
 ALLOW button, 20-5
 COM Override buttons, 20-3–20-4
 CRUS button, 20-11
 DED and, 17-8, 20-2
 ENTR button, 20-12
 F-ACK button, 20-5–20-10
 increment and decrement buttons, 20-2
 LINK button, 20-11–20-12
 Master Mode buttons, 20-2–20-3
 MRK button, 20-12
 NAV button, 20-3
 overview of, 17-8
 Priority Function buttons, 20-4–20-12
 radio communication channels, 20-3–20-4
 steerpoints and, 3-19
 STPT button, 20-10–20-11
 T-ILS button, 20-4
 Identification Management commands, 23-11
 IFF button, 17-6
 IFF FAULT caution light, 17-22
 ILS (Instrument Landing System)
 data in HSI, 3-8–3-9
 HUD mode, 18-35
 Incoming view, 22-8
 induced drag, 25-3–25-4
 infrared-guided missiles, 7-2, 7-5, 26-2, 26-4
 ingress phase in missions, 27-12
 INS (Inertial Navigation System), 3-18
 Instant Action
 ending, 9-4
 Map, 9-3
 Options, 9-2–9-3
 overview of, xvi
 Sierra Hotel, 9-4
 starting, 9-2
 instrument panels. *See* consoles
 intercept missions, 11-32
 intercept steering cue, 21-13

intercept tactics, 26-7–26-10
 interdiction missions, 11-33
 Internal view, 14-4
 Inventory page in MFD, 19-16–19-18
 Invulnerability option, 16-4
 IR-guided missiles, 7-2, 7-5, 26-2, 26-4
 iron bombs, 18-18
 Isometric view, 14-5

J

jets. *See* aircraft
 joysticks, setting up, 16-11–16-14
 JSTARS Replay window, 12-19

K

keyboard mappings, changing, 16-14
 keyboard shortcuts for radio commands, 23-2
 kinematics, 4-23
 kneeboard, 17-13
 Korean Campaign Medal, 13-7–13-8

L

Labels option, 14-7, 16-5, 22-9
 ladder intercepts, 26-9
 landing gear
 handle, 17-16
 lowering, 3-3
 raising, 1-16
 status lights, 17-15
 landings
 approach procedures, 24-3–24-5
 emergency landings, 24-6
 flameout landings, 3-14–3-17
 flare maneuver in, 3-6
 instrument landings, 3-7–3-13
 orbiting before, 24-4–24-5
 overview of, 24-6
 from 10 nm out on final approach, 3-2–3-6
 Launch light, 17-7
 LCOS (Lead Computing Optical Sight),
 4-17–4-18, 18-15–18-17
 LE FLAPS caution light, 17-22
 "leading the target," 4-15–4-16



LGBs (Laser-Guided Bombs). *See also* air-to-ground weapons

- at Easy Avionics setting, 19-11
- dropping in boresight mode, 5-44–5-45, 5-50–5-51
- dropping in slave mode, 5-43–5-44, 5-47–5-50

HUD modes for, 18-29–18-31

mechanization, 5-45

MFD display, 5-45–5-46

MFD page, 19-10–19-11

overview of, 5-42–5-43

vs. GBUs, 5-43

lift

defined, 25-3

stalls and, 25-7–25-8

Lift Line option, 16-8, 22-10

lift vector, 4-5, 25-5–25-6

lights. *See* caution lights; warning lights

Linear Altitude Plot button, 11-19

lineup cards, 27-3

LINK button, 20-11–20-12

"LOCK-LOCK" voice message, 17-14

locking onto targets

in Easy radar, 21-3–21-4

in Simplified radar, 21-6–21-7

Log Altitude Plot button, 27-19

Logbook

adding entries in, 13-2

Callsign field, 13-3

Campaign statistics, 13-5–13-6

Career statistics, 13-5

Dogfight statistics, 13-6

Medals area, 13-7–13-8

opening, 13-2

overview of, xvii

Password field, 13-3

Personal Data area, 13-4

Pilot field, 13-3

pilot picture area, 13-3

Rank area, 13-4

Squadron area, 13-4

Voice field, 13-3

Look Closer feature, 22-10

Louie, Gilman "Chopstick," A-2, A-3

LOW button, 17-18

M

Mach indicator, 18-5

magnetic compass, 17-21

magnification options, 14-8

MAN (Manual) radar mode, 5-5

maps. *See also* Planning Map

Event Map, 12-11, 12-12

Mission Builder map, 11-17–11-21

of airports, C-2

setting start time and place on, 9-3

Theater Map, 11-2, 12-9

zooming in and out of, 11-19, 12-14

Master Caution light, 17-5

Match Play dogfights, 10-4–10-5

Mavericks. *See* AGM-65 Maverick missiles

max G force indicator, 18-4

Maximize button, 12-14

Medium-Range Missiles (MRMs),

18-8–18-11

MFDs (Multifunction Displays)

of AGM-65 Mavericks, 5-32–5-38,

19-8–19-9

air-to-air guns page, 19-15–19-16

air-to-air missiles page, 19-7–19-8

of air-to-air radar modes, 4-2

air-to-ground bombs/rockets page,

19-13–19-14

air-to-ground guns page, 19-15

air-to-ground missiles page, 19-8–19-13

FCR page, 19-6, 21-9

HARM page, 19-11–19-12

in HTS, 5-53–5-55

HUD Only view and, 19-3

HUD page, 19-18

Inventory page, 19-16–19-18

LGB page, 5-45–5-46, 19-10–19-11

Main Menu page, 19-3

MFD pages, 19-3–19-18

Option Select Buttons on, 19-2–19-3

overview of, 19-2

RWR page, 19-18

S-J page, 19-18

SMS page, 19-6–19-18

TARS page, 19-12–19-13

Missile Override HUD/radar mode, 18-18, 21-18

missile threats. *See also* enemy threats; TWS countermeasures for, 7-6–7-7 dealing with SAMs, 17–19 defensive BFM against, 8-13–8-14 from IR-guided missiles, 7-2, 7-5 missile flight paths, 7-4–7-5 practicing reactions to, 7-7–7-9 from radar-guided missiles, 7-3–7-4, 7-6 Threat Warning System and, 7-5–7-6

missiles. *See* air-to-air weapons; air-to-ground weapons; SAMs

mission execution

- attack phase, 27-20–27-21
- crossing FLOT, 27-13–27-15
- dealing with AAA, 27-19
- dealing with enemy aircraft, 27-16–27-17
- dealing with SAMs, 27-17–27-19
- egress phase, 27-21–27-22
- ingress phase, 27-12–27-15
- overview of, 27-22
- takeoffs, 27-12
- threat reaction techniques, 27-15

Mission Management commands, 23-7–23-8

Mission options in Instant Action, 9-3

mission planning

- changing flight plans, 12-20, 27-4–27-6
- checking for enemy threats, 27-10–27-11 with Flight Planner, 11-25–11-27, 12-21–12-22, 27-3, 27-5
- ground operations, 27-11–27-12
- overview of, 27-2–27-3
- packages, adjusting spacing in, 27-6–27-7
- packages, defined, 27-3
- on Planning Map, 12-11, 12-13–12-15, 27-4–27-6, 27-8–27-11
- target planning, 27-8–27-9

missions. *See also* Campaign; Tactical Engagement; Training Missions

- defined, 11-16
- of enemy fighters, 26-6–26-7
- selecting roles for, 11-32–11-33
- selecting type of, 11-38

MK bombs, 18-24

MPO (Manual Pitch Override) switch, 17-18

MRGS (Multiple Reference Gun Sight), 18-15

MRK button, 20-12

MRLMs (Medium-Range Missiles), 18-8–18-11

MSL (Missile Override) HUD/radar mode, 18-18, 21-18

“Muds,” 27-17

munitions. *See also* air-to-air weapons; air-to-ground weapons

- window, 11-27–11-30, 12-22–12-24
- viewing data on, 15-2–15-4

N

Naval button, 17-7

navigation. *See also* steerpoints

- Global Positioning System, 3-18
- with HSD, 3-22, 3-25–3-26, 19-5
- with HSI, 3-21, 17-12–17-13
- HUD steering cues, 3-19, 3-20–3-21
- ICP in, 3-19
- Inertial Navigation System, 3-18
- NAV HUD mode, 18-7–18-8
- NAV Master Mode button, 20-3
- padlocking priorities, 22-7
- route in HSD, 19-5
- to selected steerpoints, 3-20–3-21
- to steerpoints on time, 3-23–3-24
- system overview 17-24–17-26
- training mission on, 3-25–3-26

NCTR (Non-Cooperative Target Recognition) system, 21-13

No Blackout option, 16-5

No Collisions option, 16-5

nozzle position indicator, 17-9

NRM radar mode, 5-5

NVG (Night Vision Goggles) feature, 22-10

NWS FAIL caution light, 17-22

O

Object Density options, 16-8

Object Detail options, 16-7

OCA Strike missions, 11-33

offensive BFM. *See also* BFM

- airspeed control and, 8-4–8-5
- corner airspeed and, 8-4
- energy and, 8-5



overview of, 8-2–8-3, 8-5
 training mission using, 8-6–8-8
 turn rate and radius and, 8-4

oil pressure indicator, 17-9

On-Call CAS missions, 11-33

OOB (Order of Battle) window, 11-23, 12-18

Options area in Instant Action, 9-2–9-3

orbiting before landing, 24-4–24-5

Orbit Vehicle rotation control, 14-6–14-7

Orbit view, 14-4, 22-9

OSBs (Option Select Buttons), 19-2–19-3

OVERHEAT caution light, 17-22

OVRD (Override) radar mode, 5-6, 21-28

ownership indicator in HSD, 19-4

P

packages

adjusting spacing in, 27-6–27-7

defined, 11-16, 27-3

Padlock view, 16-4, 22-5–22-7

photos

of assets, 15-4

of pilots, 13-3

pirouette turns, 2-18, 2-22–2-23

pitch

defined, 2-20

horizontal pitch bar, 3-12

pitch ladder, 1-6, 18-5

Planning Map. *See also* maps; mission

planning

changing flight plans on, 12-20,

27-4–27-6

checking enemy threats on,

27-10–27-11

overview of, 12-11, 12-13–12-15

planning targets on, 27-8–27-9

Player Bubble option, 16-8

pointing cross in Maverick MFD display,

5-32, 5-33–5-34

points for victory, 11-39

predictor sights, 4-18

Pre-Plan CAS missions, 11-33

printing ACMI screen shots, 14-8

Priority Mode button, 17-7

“PULLUP–PULLUP” voice message, 17-14

PWR button, 17-18

R

radar. *See also* air-to-air radar modes; air-to-ground radar modes; Realistic radar; RWR; RWS

Easy option for, 21-2–21-5

in enemy defense systems, 26-2

jamming, 21-25

Lock Line option, 14-7

options, 21-2

overview of, 21-2

vs. padlocking, 22-6

RADAR ALT caution light, 17-22

radar-guided A-A missiles, 7-3–7-4, 7-6.

See also AIM-7 and AIM-120 missiles

radar-guided SAMs, 26-4–26-5

radar returns, 21-26

Realistic option for, 21-9–21-24

Simplified option for, 21-5–21-9

radial G (GR), 2-13

Radio Calls Use Bullseye option, 16-5

radio channel selector, 17-18–17-19

radio commands. *See also* Flight radio commands

AWACS commands, 23-2–23-4

Element commands, 23-4

Flight commands, 23-4–23-11

keyboard shortcuts for, 23-2

on Vector Page, 23-3–23-4

Tanker commands, 23-12

Tower commands, 23-11

Wingman commands, 23-4

radio communication channels, 20-3–20-4

radio function knob, 17-20

range

readouts, 21-17

rings in HSD, 19-5

scale in HSD, 19-4

scale in MFD, 21-29

in Simplified radar, 21-8

window in HSI, 3-8

RCKT HUD mode, 5-30, 18-25

reacquisition elevation symbol, 21-13

Realism Ratings, 16-3

Realistic radar. *See also* air-to-air radar modes; air-to-ground radar modes; radar air-to-air modes in, 21-9–21-24 air-to-ground modes in, 21-25–21-32 overview of, 21-9 selecting modes on FCR page, 21-9

Recon missions, 11-33

Reconnaissance Pod HUD mode, 18-34

recording flight data. *See* ACMI redouts, 22-10, 25-5

Reference, Tactical, 15-2–15-4

Reflection option, 16-8

refueling. *See* air-to-air refueling “relaxed static stability,” 2-19

RESCAP missions, 11-32

Resolution options, 16-6

restoring saved missions, 11-40

reticle, 18-9, 18-12

reviewing flight data. *See* ACMI

right eyebrow warning lights, 17-8–17-9

rockets (air-to-ground), 5-30–5-31, 18-25

roles for missions, 11-15, 11-32–11-33

rolls

- defined, 2-20
- lift vector and, 25-5–25-6
- vertical roll bar, 3-12

rotation control, 14-6–14-7

RP (Ripple) bomb dropping options, 18-23

RPM gauge on HUD, 1-9, 17-9, 18-7

RPOD HUD mode, 18-34

rudder setup, 16-11

RWR (Radar Warning Receiver). *See also* radar

- audio tones, 15-4
- MFD page, 19-18
- overview of, 17-6–17-7
- panel, 15-4
- PWR button, 17-18
- SRCH button, 17-18

RWS (Range While Search) radar mode

- antenna tilt options, 4-9
- azimuth sweep options, 4-8
- bar scan options, 4-8–4-9
- defined, 21-17
- in SAM mode, 4-10–4-11
- overview of, 21-18–21-19

- range options, 4-8
- RWS-SAM submode, 21-19–21-20
- search options, 4-7–4-9
- targets, 4-10
- training mission using, 4-13–4-14

S

S-J (Selective Jettison) page in MFD, 19-18

SA (Situational Awareness) bar, 22-4–22-5

SA-2 missiles, 26-3

SA-6 missiles, 26-2

SA-9 missiles, 26-2

SAM (Situational Awareness Mode) radar, 21-18, 21-19–21-20

SAMs (Surface-to-Air Missiles). *See also* missile threats

- dealing with threats from, 27-17–27-19
- IR-guided SAMs, 26-2, 26-4

Satellite view, 14-5, 22-8

saving

- campaigns, 12-6–12-7, 12-25
- engagements, 11-40

scales switch, 17-16–17-17

Schwarzkopf, Norman, 12-2

Scramble mission, 12-25

SEA radar mode, 5-2, 5-5, 21-32

SEAD Escort missions, 11-33

SEAD Strike missions, 11-33

Setup

- Controllers, 16-11–16-14
- for Training Missions, 1-3
- Graphics, 16-6–16-9
- joysticks, 16-11–16-14
- keyboard mapping, 16-14
- overview of, 16-2
- Simulation, 16-2–16-5
- Sound, 16-10–16-11

ships, viewing data on, 15-2–15-4

shortcuts for radio commands, 23-2

Short-Range Missiles (SRMs), 18-11–18-13

Sidewinder. *See* AIM-9 missiles

Sierra Hotel window, 9-4, 12-20

Silver Star medal, 13-7–13-8

Simplified Avionics option, 18-36



- Simplified radar
 - in air-to-air mode, 21-6–21-8
 - in Ground Map mode, 21-9
 - overview of, 21-5–21-6
 - Simulation setup, 16-2–16-5
 - single side offset intercepts, 26-8
 - Skill Level options, 16-2
 - Slammer. *See* AIM-120 AMRAAM missiles
 - slave mode
 - dropping LGBs in, 5-43–5-44, 5-47–5-50
 - firing Mavericks in, 5-37–5-38, 5-41–5-42
 - HUD display, 18-28–18-29, 18-31
 - Sleuable radar mode, 4-6, 21-23–21-24
 - SMS (Stores Management System). *See also* MFDs
 - A-A guns page, 19-15–19-16
 - A-G bombs and rockets page, 19-13–19-14
 - A-G guns page, 19-15
 - AAM page, 19-7
 - AGM page, 19-8–19-13
 - HARM page, 19-11–19-12
 - Inventory page, 19-16–19-18
 - LGB page, 19-10–19-11
 - Maverick page, 19-8–19-9
 - overview of, 19-6–19-7
 - S-J page, 19-18
 - TARS page, 19-12–19-13
 - SNAP (Snapshot) HUD mode, 4-19, 18-17
 - SOI (Sensor of Interest), 18-6
 - sorties, 11-16, 11-38
 - sound features
 - low speed warning, 1-12–1-13, 17-14
 - heat-seeking missile tones, 4-23, 18-13
 - radar signals, 15-4
 - setting options for, 16-10–16-11
 - in Threat Warning System, 7-5, 7-6
 - Voice Message System, 17-13–17-14, 18-6
 - SP (Snowplow) radar mode, 5-6, 5-11, 21-28
 - Special Effects options, 16-8
 - Specific Energy, 2-3–2-4
 - Specifications of objects, 15-2–15-4
 - speed brakes position indicator, 17-16
 - “Spikes,” 27-17
 - split plane maneuvering, 26-10
 - Squadron Status window, 11-35
 - Squadron window, 12-19–12-20
 - SRCH button, 17-18
 - SRM HUD mode, 18-11–18-13
 - stalls
 - defined, 2-20
 - overview of, 25-6–25-8
 - recovering from, 2-23–2-24
 - start time, setting, 11-38
 - starting Instant action, 9-2
 - steerpoints. *See also* navigation
 - in air-to-ground radar, 21-26
 - defined, 3-18
 - marker on HUD heading scale, 3-20, 18-5
 - modifying, 3-19, 12-20–12-21, 27-4–27-6
 - NAV mode diamond on HUD, 3-20, 18-7
 - navigating to, 3-20–3-21
 - navigating to on time, 3-23–3-24
 - readouts on HUD, 18-8
 - STP radar mode, 5-6, 5-10–5-11, 21-29
 - STPT button, 20-10–20-11
 - symbol in air-to-air radar, 21-12
 - stores. *See* SMS
 - STRF (Strafe) HUD mode, 5-28, 18-33
 - Strike missions, 11-33
 - STT (Single Target Track) radar mode, 21-18, 21-24
 - Summers, “Shooter,” 8-15
 - sweep missions, 11-32, 26-7
- ## T
- T-ILS button, 20-4–20-5
 - T/L CFG warning light, 17-8
 - TACAN (Tactical Air Navigation) system
 - channel selector, 17-20, 17-24
 - function knob, 17-20, 17-24
 - overview of, 17-24–17-26
 - setting TACAN channel, 3-10, 24-3

- Tactical Engagement. *See also* Campaign; mission planning
 - Add Battalion window, 11-18, 11-35–11-36
 - Add Flight window, 11-18, 11-31–11-32
 - Add Package window, 11-18, 11-34–11-35
 - Add Squadron window, 11-19, 11-35
 - adding ground strikes, 11-5–11-8
 - adding opposition, 11-9–11-10
 - adding victory conditions, 11-11–11-14
 - ATO (Air Tasking Order) tool, 11-22–11-23
 - Battalion Status window, 11-36
 - building simple missions, 11-5–11-15
 - building complex missions, 11-15–11-40
 - vs. Campaign, 11-3
 - changing loadouts, 11-30–11-31
 - clock, 11-19
 - editor tools, 11-17
 - exiting missions, 11-40
 - Fit Flight Plan button, 11-19
 - Flight Plan tool, 11-25–11-27
 - Help, 11-18, 11-22
 - Linear Altitude Plot button, 11-19
 - Load Mission section, 11-2
 - loading missions, 11-4, 11-14–11-15
 - Log Altitude Plot button, 11-19
 - Mission Briefing tool, 11-24
 - Mission Builder, 11-17
 - Mission Builder map, 11-18–11-21
 - Mission Builder tools, 11-22–11-31
 - Mission Builder windows, 11-31–11-36
 - Mission Description section, 11-3
 - Munitions tool, 11-27–11-30
 - OOB (Order of Battle) tool, 11-23
 - opening screen of, 11-2–11-3
 - opening training missions, 11-3
 - overview of, xvi, 11-2, 11-15, A-7
 - playing missions, 11-3–11-4, 11-14–11-15
 - restoring missions, 11-40
 - saving missions, 11-40
 - selecting mission roles, 11-32–11-33
 - selecting mission type, 11-38
 - setting start time, 11-38
 - setting time limits, 11-39
 - Squadron Status window, 11-35
 - Team Selector button, 11-18
 - Teams window, 11-36–11-37
 - terminology, 11-15–11-16
 - Theater Map, 11-2, 11-37
 - Victory Conditions window, 11-38–11-40
 - zoom controls, 11-19
- Tactical Reference, xvii, 15-2–15-4
- tadpole marker in NAV HUD mode, 3-21, 18-7
- “take spacing” voice message, 24-4
- takeoffs
 - from airports, 24-2–24-3
 - in Campaign, 12-24–12-25
 - in mission execution, 27-12
 - training mission on, 1-13–1-16
- Tanker radio commands, 23-12
- TARCAP missions, 11-32
- targets
 - cueing with CCRP, 5-12
 - locking onto in Easy radar, 21-3–21-4
 - locking onto in Simplified radar, 21-6–21-7
 - planning attacks on, 27-8–27-9
 - TD (Target Designator) box, 18-9
 - TGT SEP button, 17-7
- TARS (Tactical Aerial Reconnaissance System), 18-34, 19-12–19-13
- taxiing before takeoff, 24-2
- Team Furball dogfights, 10-4
- Team Selector button, 11-18
- team, defined, 11-16
- Teams window, 11-36–11-37
- Terrain Detail options, 16-7
- Terrain Texture options, 16-7
- Texture Smoothing option, 16-7
- Textured Objects option, 16-7
- TGT SEP button, 17-7
- Theater Map, 11-2, 11-37, 12-9
- Threat Warning System. *See* TWS
- threats. *See* enemy threats; missile threats
- 3-D model displays, 15-3
- throttle setup, 16-11
- throttle positions, 25-3
- thrust, 25-3
- time limits, setting, 11-39
- timing in navigation, 3-23–3-26
- TOS (Time Over Steerpoint), 11-25, 27-3
- TOT (Time Over Target), 27-3
- Tower radio commands, 23-11



- tracking gates in Maverick MFD , 5-32–5-33
- Tracking view, 14-5, 22-8
- trail intercepts, 26-9
- Training Missions. *See also* missions defined, 11-33
 - Freeze mode and, 1-4
 - loading, 1-3
 - opening, 11-3
 - overview of, 1-2
 - Setup, 1-3
- Training Mission 1: Basic aircraft handling, 1-4–1-13
- Training Mission 2: Takeoff, 1-13–1-16
- Training Mission 3: Max G turn at corner airspeed, 2-2–2-7
- Training Mission 4: Max G turn well above corner airspeed, 2-7–2-10
- Training Mission 5: Max G turn well below corner airspeed, 2-10–2-12
- Training Mission 6: Minimum altitude Split S turn, 2-12–2-16
- Training Mission 7: High-speed over-the-top maneuver, 2-16–2-19
- Training Mission 8: Low-speed over-the-top maneuver and departures, 2-19–2-24
- Training Mission 9: Landing from 10 nm out on final, 3-2–3-6
- Training Mission 10: Landing from a base leg position using the instruments, 3-7–3-13
- Training Mission 11: Flameout landing, 3-14–3-17
- Training Mission 12: Navigation and timing, 3-18–3-26
- Training Mission 13: Air-to-air radar modes, 4-2–4-14
- Training Mission 14: 20mm cannon (air-to-air), 4-14–4-21
- Training Mission 15: AIM-9 Sidewinder, 4-21–4-27
- Training Mission 16: AIM-120 AMRAAM, 4-27–4-30
- Training Mission 17: AIM-7 Sparrow, 4-30–4-34
- Training Mission 18: Air-to-ground radar modes, 5-2–5-11
- Training Mission 19: CCRP with unguided bombs, 5-12–5-17
- Training Mission 20: CCIP bombing, 5-17–5-23
- Training Mission 21: Dive Toss with unguided bombs, 5-23–5-27
- Training Mission 22: 20mm cannon (air-to-ground), 5-28–5-30
- Training Mission 23: Rockets, 5-30–5-31
- Training Mission 24: AGM-65 Maverick missile, 5-32–5-42
- Training Mission 25: Laser-guided bombs, 5-42–5-52
- Training Mission 26: HARM air-to-ground missile, 5-52–5-58
- Training Mission 27: Air-to-air refueling, 6-2–6-8
- Training Mission 28: Missile threat reaction, 7-2–7-10
- Training Mission 29: Offensive BFM, 8-2–8-8
- Training Mission 30: Defensive BFM, 8-8–8-14
- Training Mission 31: Head-on BFM, 8-14–8-20
- Transparency option, 16-7
- TTG (Time To Go) readouts, 18-8
- turns. *See also* BFM
 - ADI in, 3-11
 - aircraft G and, 2-2
 - airspeed and, 2-2–2-4
 - corner airspeed, 2-3, 8-4
 - drag index and, 2-4
 - gravity and, 2-13
 - high-speed over-the-top turns, 2-16–2-19
 - in horizontal plane, 2-4–2-12
 - low altitude level turns, 1-11
 - low-speed over-the-top turns, 2-19–2-24
 - max G turns above corner speed, 2-7–2-10
 - max G turns at corner airspeed, 2-2–2-7
 - max G turns below corner speed, 2-10–2-12
 - minimum altitude Split S turns, 2-12–2-16

- overview of, 1-10, 1-11
- pirouette turns, 2-18, 2-22-2-23
- recovering from deep stalls, 2-23-2-24
- turn rate and radius, 2-2-2-4, 8-4
- in vertical plane, 2-12-2-24
- 20mm cannon (air-to-air). *See also* gun sights
 - EEGS gun sight for, 4-18-4-19, 18-14-18-15
 - gun sight theory and, 4-15-4-17
 - LCOS gun sight for, 4-17-4-18, 18-15-18-17
 - Snapshot line gunsight for, 4-19, 18-17
 - training mission using, 4-19-4-21
- 20mm cannon (air-to-ground), 5-28-5-30
- 2-D Cockpit view, 22-2-22-3
- TWS (Threat Warning System). *See also*
 - enemy threats; missile threats defined, 17-6
 - missile threats and, 7-5-7-6
 - on front console, 17-6-17-8
 - on left console, 17-18
 - symbols, 7-5-7-6
 - warning lights, 7-5, 17-7-17-8, 17-18
 - warning sounds, 7-5-7-6
- TWS (Track While Scan) radar mode, 4-11, 21-17, 21-20-21-21

U

- Unable command, 23-3
- UNK button, 17-7
- Unlimited Chaff and Flares option, 16-5
- Unlimited Fuel option, 16-5

V

- VAH scales, 17-17
- Vector radio commands, 23-3-23-4
- Vehicle Magnification options, 16-8
- vehicles, viewing data on, 15-2-15-4
- velocity switch, 17-17
- vertical control, 14-6
- vertical roll bar, 3-12
- Vertical Scan radar mode, 4-4-4-5, 21-23
- Victory Conditions window, 11-38-11-40. *See also* winning campaigns

- Video Card options, 16-6
- Video Driver options, 16-6
- views
 - Action view, 22-8
 - Canopy Reflections feature, 22-10
 - Chase view, 22-9
 - controls for inside views, 22-3-22-4
 - controls for outside views, 22-8
 - Extended Field of View, 16-4, 22-7
 - Enemy view, 22-8
 - Flyby view, 22-9
 - Friendly Ground Unit view, 22-9
 - Friendly view, 22-9
 - glancing forward and backward in, 22-10
 - HUD Only view, 22-2
 - Incoming view, 22-8
 - inside views, 22-2-22-7
 - Labels feature, 22-9
 - Lift Line feature, 22-10
 - Look Closer feature, 22-10
 - manipulating, 14-6
 - Night Vision Goggles feature, 22-10
 - Orbit view, 22-9
 - outside views, 22-8-22-9
 - Padlock view, 16-4, 22-5-22-7
 - redouts and, 22-10
 - Situational Awareness bar and, 22-4-22-5
 - Satellite view, 22-8
 - selecting, 14-4-14-6
 - special features in, 22-9-22-10
 - Tracking view, 22-8
 - 2-D Cockpit view, 22-2-22-3
 - Virtual Cockpit view, 22-4-22-5
 - Weapon view, 22-8
 - Weapon's Target view, 22-9
 - zooming in on, 22-10
- VMS (Voice Message System), 17-13-17-14, 18-6
- VS (Velocity Search) radar mode, 4-12, 21-17, 21-21-21-22
- VV (Vertical Velocity) scale, 17-16-17-17
- VVI (Vertical Velocity Indicator), 17-11



W

- warning lights. *See also* caution lights
 - Break-X indicator, 18-6
 - vs. caution lights, 17-6
 - on front console, 17-7–17-8
 - in Threat Warning System, 7-5–7-6, 17-7–17-8, 17-18
 - on left console, 17-18
 - left eyebrow warning lights, 17-6
 - for low fuel, 18-6
 - right eyebrow warning lights, 17-8–17-9
- warning messages. *See* VMS
- warning sounds. *See* sound features
- Wave options in Instant Action, 9-3
- Weapon view, 22-8
- weapons. *See* air-to-air weapons; air-to-ground weapons; munitions; SAMs
- Weapons Effects options, 16-3
- Weapon's Target view, 22-9
- weight, 11-28–11-29, 25-4
- Wilco command, 23-3
- Wing Trails option, 14-8
- Wingman radio commands, 23-4
- winning campaigns, 12-26. *See also* Victory Conditions window
- Wireframe Terrain option, 14-8

Y

- yaw, 2-20

Z

- zooming in and out
 - in EXP radar mode, 5-5–5-6, 5-9–5-10, 5-37
 - of maps, 11-19, 12-14
 - of views, 14-6, 22-8, 22-10

Producers

Gilman "Chopstick" Louie
Steve "Grout" Blankenship

Engineering

Vincent "The Blade" Finley
Ed "Hollywood" Goldman
Robin "Goliath" Heydon
Kevin "Waffen" Klemmick
Dave "Gremlin" Power
Scott "Curiosity" Randolph
Leon "Super Fly" Rosenshein
Joe "Smokin'" Ward
Peter "Bandit" Ward

Art

Dave Adams
Jimmy "Zorro" Gutierrez
Christian Ingle
Greg Smith
Christopher "Slasher" Wren

Contributing Art

Bill Ferguson
Eddie Edwards
John Edwards
Josh Ferguson
Wella "Screamer" Lasola
Jason Rossilli
Stewart Stanyard "Tzoneman"

Terrain

Eric "Eveready" Grotke

Music and Sound

Paul "Moggy" Mogg
Scott Petersen
J White

Engineering Support

Kevin "Pig Pen" Ray
Gary Gibbons
Erick "Jetblaster" Jap
Kuswara "Pork Chop" Pranawahadi
Marc Reynolds
Paul "Smooth G" Schlegel
Billy "Scarface" Sutyono



Subject Matter Experts

Pete "Boomer" Bonanni
 Jamie "Linus" Reiner
 Craig "Soup" Campbell
 Dave "Omar" Bradley
 Charlie "Gorilla" Smith
 Willis "Ghost" Emery
 Wolf "Whisper" Griffey
 Col. Phil "Hands" Handley, USAF (Ret.)

Quality Assurance

Leon "El Jefe" Horne II
 Randy "Pins" Lee
 James "Hook" Bostick
 Anthony "Harbinger 6" Constantino XXVII
 Mike "Patton" Gonos
 Steve "Professor" Head
 Jake "Jethro" Hopkins
 Tony "Tiger" Hunter
 Gerald "Shazam" Jones
 Brian "Menace" King
 Ryan "Rookie" Natale
 Mike "Slapshot" Orenich
 Bill "Cpt. Chaos" Schmidt
 Yobo "Loco" Shen
 Mark "Faceman" Smith
 Phoenix "Hamburger" Valencia
 Larry "Lawn Dart" Webber

Build Master

Robin "Master" Roberts

Documentation

Marisa "No. 19" Ong
 Greg "G-Man" Aaron
 Pete "Boomer" Bonanni
 Howard "Whiplash" Bornstein
 Lynnzee "froot loops" Elze
 Robert "Spaceman" Giedt
 Steve "Professor" Head
 Lawrence "Guzzler" Kevin
 Peter "Genghis" Kuhns
 Jamie "Linus" Reiner
 Stephen "Auger Dogger" Santamaria
 Robert "Wombat" Woods

Marketing

Tom "Hollywood" Nichols
 Matt Carroll
 Jason Dutton
 Kathryn Lynch
 Joseph "Joltin' Joe" Olin
 Kathy "Ruddy" Sanguinetti
 Reiko "Dazzling" Yamamoto

Localization

Daniel "Bunsen" Berner
 Karen "Peb" Ffinch
 Vansouk "Vegas" Lianemany
 Andrea "Bobby" Held
 Andrew "Joker" Thomas
 Chan "Blue Jay" Saechao
 D'Juan "Shadow" Bragg
 Eddie "Madman" Lai
 Tom "Tombear" Schmidt
 SDL International

MIS Support

Dan "The Man" Welch

Quality Assurance

(Hunt Valley–MicroProse)

Tom "Gold Dust" Falzone
 Carl "Sleepy" Johnson
 Greg "Handyman" Schneider
 Jason "Lightning" Gleason
 Mark "Gucci" Gutknecht
 Mike "Cougar" Davidson
 Nathan "Lefty" Wright
 Paul "Ambush" Ambrose
 Steven T. "AWOL" Purdie

Hasbro Interactive, Inc.

Alan Hassenfeld
 Harold "Sonny" Gordon
 Tom Dusenberry
 Tony "Belize" Parks
 Michael "Buddha" Craighead
 Kurt "Goat Killer" Boutin
 Andy "Frosty" Mazurek
 Bill Carroll

Dan McJilton
Bob Sadacca
Eric "Slush" Scheman
Ian "Gilligan" Giffen
Mark Huggins
Tracy Kureta

Voice Actors

Alfred Thor
Andy Valvur
Ari Ross
Bill Timoney
Christy Mathewson
Dave Mallow
Devin Graham
Dick Kellogg
Jackson Daniels
Jamison Jones
Jill Jaxx
Jimmy Theodore
Karen Kearns
Marilyn McDonald
Michael Mancuso
Michael McConnohie
Paul Mogg
Randy Montgomery
Reyni Doty
Steve Kramer
Tom Benkert
Hyungmin Stephen "Vibe Master" Moon

Beta Testers

209th Delta Hawks

Jeffery "Rhino" Babineau
Dan "Crash" Crenshaw
Robert "Tango" Fakes Jr.
Troy "Big Foot" Fisher
John "Vibe" Mace
Lou "Yoda" Mayers
Ken "Grizzly" Webb
Bryce "Stain" Whitlock
Phil "Surfer" Worthen

469th

Jon-Paul Griffin

Willie Langer
Jody Levesque
Dan Trottier
Vernon Tunstill
Robert Yuristowski

Beta Test Group

Christopher "Bones" Bonner
Adam Breidenbaugh
Paul Cabana
Rick "Storm Shadow" DiRicco
Mark "Boxer" Doran
Paul Drousalis
James Ellis
Ron Going
Jon-Paul Griffin
Jim Hays
William "Motown" Hodder
Buzz Hoffman
Bruce Hook
Richard Lane
Willie Langer
Thomas Launder
Mike McGuirk
Sean Mikel
Rufus Parson
Davin Patton
Chris Randall
Fausto Romeo
Per I. Saelid
Chris Schroeder
Michael Scott
John Simon
Mark Starret
Dan Trottier
Vernon Tunstill
Steve Voege
Tony Vulpitta
Matt "Wags" Wagner
Tennie Winslow
Robert Yuristowski
Victor "Duke" Zaveduk
Korea Intelligence
Dave Davenport



Photos

U.S. Air Force
Michael Klauer
American MPC
Maris Multimedia
Gilman Louie
Greg Smith

Special Thanks

Bill Burns
Bing Crowell
Joseph Colligan
Jim Dizoglio
Dave King
Guymond "Smiley" Louie
Dan "Danbert" Moen
Steve Race
Robin Scheer
Pat Schmidt
Joe Scirica
Kip Welch
Absolute Quality, Inc., Hunt Valley, MD
Alba Communications, Burbank, CA
Cornyn Partners
Infinite Studios, Alameda, CA
Lernout & Hauspie
Live Oak Studios, Berkeley, CA
Louis Saekow Design
Mitchell Agency, San Francisco, CA
Planned Marketing Solutions
Quixotic Design
Ram Nalla, Intel, Santa Clara, CA
Tonry Talent, San Francisco, CA
BBC Worldwide Americas, Inc.
Rod Hughes, 3Dfx
Jack Mathews, 3Dfx
Andy Rothfus, 3Dfx
Michael Smith, ATI
Nitya Vlaganathan, ATI
Doug Rogers, NVidia

If you have any questions about *Falcon 4.0*, please contact MicroProse Customer Support at:

- ✦ Microprose/Hasbro Interactive (Europe) Customer Services,
The Ridge
Chipping Sodbury,
S Gloucestershire
BS37 6BN

- ✦ Telephone: 01454 893900
Fax: 01454 894296
Hours of Operation:
9am - 5.30pm GMT, Monday to Friday

- ✦ World Wide Web
www.microprose.com

- ✦ Email:
uksupport@hiuk.com

WWW.FALCON4.COM

Falcon 4.0 has an exciting Web site dedicated to ensuring you get the most out of your new game. Visit us at www.falcon4.com and discover technical support, tips on techniques from real F-16 pilots, downloadable missions, message boards, software updates, information on virtual fighter squadrons, links to related sites and more! We are constantly updating our *Falcon 4.0* Web site so stop by and visit us frequently.

INTERNET:

You can read the latest news and information about MicroProse on our World Wide Web page at www.microprose.com. Our Web site includes technical support, hints and tips, software updates, demos, screen shots and much more! We are constantly updating our Web site, so stop by and visit us frequently. Download files from our FTP site at ftp.microprose.com. Send electronic mail to Customer Support at support@microprose.com.



HOW TO GET HELP:

If you are having problems with *Falcon 4.0*, we can best help you if (1) you are at your computer when you call and (2) you have the following information handy:

- ✦ Version number of *Falcon 4.0*
- ✦ Your computer's processor and its speed (such as a 166MHz Pentium)
- ✦ Your computer's brand and model
- ✦ Total RAM installed in your computer
- ✦ Version of DirectX drivers
- ✦ CD-ROM brand and model name
- ✦ Video card brand and model name
- ✦ Sound card brand and model name
- ✦ Mouse brand and version number of mouse driver
- ✦ Joystick brand and model name
- ✦ Any error message you see in the game

HOW TO RETURN DEFECTIVE MATERIALS:

If your game manual or CD-ROM is damaged or defective, you can return that item to Customer Support for a replacement. Send *only* the item to be replaced, not the whole game package. You *must* also include a photocopy of your receipt showing the date of purchase, not the date when you "registered" your game with MicroProse. Your 90-day warranty period begins with the date of purchase as shown on your receipt. MicroProse is not responsible for items lost in the mail. We suggest that you insure, register or certify your mail.

ONLINE STORE:

If you enjoyed this product and would like to purchase other great MicroProse games online, stop by the Online Store on www.microprose.com for convenient shopping from home.

MICROPROSE SOFTWARE LICENSE AGREEMENT

THE ENCLOSED SOFTWARE PROGRAM IS LICENSED BY MICROPROSE TO CUSTOMERS FOR THEIR USE ONLY ON THE TERMS SET FORTH BELOW. OPENING THIS PACKAGE OR USING THE ENCLOSED DISC INDICATES YOUR ACCEPTANCE OF THESE TERMS.

MicroProse hereby grants you a non-exclusive license to use the enclosed software and manual subject to the terms and restrictions set forth in this Software License Agreement.

This manual and the software accompanying it are copyrighted, with all rights reserved. You may not copy or otherwise reproduce any part of the software or the manual, except that you may load the software into a computer as an essential step in executing the software on the computer. The original and any back-up copies of the software and the manual are to be used only in connection with a single computer. You may physically transfer the software from one computer to another, provided that the software is used in connection with only one computer at a time. You may not transfer the software electronically from one computer to another over a network. You may not distribute copies of the software or the manual to others.

YOU MAY NOT USE, COPY, MODIFY, TRANSFER, SUBLICENSE, RENT, LEASE, CONVEY, TRANSLATE, CONVERT TO ANY PROGRAMMING LANGUAGE OR FORMAT OR DECOMPILE OR DISASSEMBLE THE SOFTWARE OR ANY COPY, MODIFICATION OR MERGED PORTION, IN WHOLE OR IN PART, EXCEPT AS EXPRESSLY PROVIDED FOR IN THIS LICENSE.

MICROPROSE NINETY-DAY LIMITED WARRANTY

To the original purchaser only, MicroProse warrants the disc on which this software product is recorded to be free from defects in materials and faulty workmanship under normal use for a period of ninety days from the date of purchase. If during this ninety-day period the disc should become defective, it may be returned to MicroProse for a replacement without charge, provided you have previously sent in your Warranty Registration Card to MicroProse or send proof of purchase of the program.

Your sole and exclusive remedy in the event of a defect is expressly limited to replacement of the disc as provided above. If failure of a disc has resulted from accident, abuse or neglect, MicroProse shall have no responsibility to replace the disc under terms of this limited warranty.

If the disc should fail after the original ninety-day limited warranty period has expired, you may return the disc to MicroProse at the address noted below, accompanied by a check or money order for the applicable replacement fee (please contact Customer Support for the exact cost), a brief statement describing the defect, and your return address. MicroProse will replace the disc provided that you have previously returned your Warranty Registration Card to MicroProse, and the disc retains the original product label.

Any implied warranties relating to the disc, including any implied warranties of merchantability and fitness for a particular purpose, are limited to a period of ninety days from date of purchase. Publisher shall not be liable for indirect, special, or consequential damages resulting from the use of this product. Some states do not allow the exclusion or limitation of incidental or consequential damages, so the above limitations might not apply to you. This warranty gives you specific legal rights, and you may also have other rights which vary from state to state.

© 1998 Hasbro Interactive and MicroProse, Inc. All Rights Reserved. MICROPROSE and FALCON are U.S. registered trademarks and HASBRO INTERACTIVE, the HASBRO INTERACTIVE logo, and FALCON 4.0 are trademarks of Hasbro or its affiliates. MicroProse is a subsidiary of Hasbro. Monotype is a trademark of Monotype Typography Limited registered in the U.S. Patent and Trademark Office and certain other jurisdictions. Haettenschweiler is a trademark of Robert Norton. All other trademarks are the property of their respective holders. The 3Dfx Interactive logo is a trademark or registered trademark of 3Dfx Interactive, Inc. in the USA and other select countries. Dolby and the double-D symbol are trademarks of Dolby Laboratories.

